

Canon

0037W434

EOS

3000N / 3000N DATE

66 / 66 DATE

REBEL
XSN

REBEL
XSN
DATE

REBEL
GII

English



E



INSTRUCTIONS

Thank you for purchasing a Canon product.

The EOS 3000N/DATE, EOS 66/DATE, EOS REBEL XS N/DATE, EOS REBEL G II is a very compact autofocus, single-lens reflex camera. It can be used for a wide variety of subjects and situations with fully automatic and user-controlled shooting modes.

Read this Instructions booklet and familiarize yourself with your new camera before taking pictures.

Symbols

-  The Caution symbol alerts you to actions to prevent shooting problems.
-  The Note symbol gives supplemental information for basic camera operation.
-  The Light bulb symbol offers helpful tips for operating your camera or taking pictures.

Also read "Handling Cautions" on page 6 to prevent camera malfunction and damage.

Keep this instruction booklet handy for easy reference.

Before Using Your Camera

- Before shooting an important event, be sure to take test shots to make sure the camera operates properly.
- EOS cameras have a lens mount for dedicated operation (autofocusing, exposure control, etc.) with Canon EF lenses. Using a non-Canon EF lens with an EOS camera may not result in proper camera or lens operation.

Note that the warranty does not cover any camera malfunction or damage occurring with the use of non-Canon products.

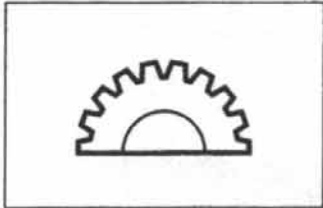

Conventions Used in this Instruction Booklet

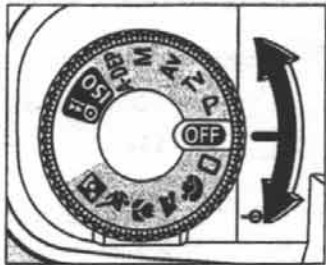

- The <  > icon indicates the Main Dial.





- All operation procedures described in this booklet assume that the Command Dial is set to a mode except < **OFF** >. Before proceeding with any operation, be sure that the Command Dial is set to a shooting mode.

-
- Page numbers in parentheses (→page ■) indicate where you can find more relevant information.
 - The camera control icons and markings used in this booklet correspond to the actual icons and markings found on the camera. See “Nomenclature” on page 10.
 - The (), (), and () icons indicate that the respective function remains in effect for 4, 6, and 16 sec. respectively after the button is released.







Contents

| | |
|---|----|
| Conventions Used in this Instruction Booklet..... | 3 |
| Handling Cautions | 6 |
| Quick Start Guide | 8 |
| Nomenclature | 10 |

1 Before You Start15





| | |
|---|----|
| Installing the Batteries and Checking the Battery Level..... | 16 |
| Mounting and Detaching a Lens..... | 18 |
| How the Shutter Button Works | 19 |
|  Loading and Unloading Film..... | 20 |
|  Midroll Rewind | 21 |
| Holding the Camera | 22 |

2 Fully Automatic Shooting23

| | |
|--|----|
| <input type="checkbox"/> Full Auto Mode..... | 24 |
| Built-in Flash | 26 |
| AF-Assist Beam | 26 |
| Single-frame and Continuous Shooting | 26 |
|  Using Red-eye Reduction | 27 |
|  Portrait Mode | 28 |
|  Landscape Mode | 29 |
|  Close-up Mode | 30 |
|  Sports Mode | 31 |
|  Night Scene Portrait Mode..... | 32 |
|  Using the Self-timer | 33 |
| Using the Eyepiece Cover | 34 |
| Imprinting the Date or Time (QD Model only)..... | 35 |

3 User-Controlled Shooting37

| | |
|---|----|
|  Selecting an AF Frame | 38 |
| Focusing Off-Center Subjects | 39 |
| When Autofocus Fails | 40 |
| Metering Modes..... | 41 |
| P Program AE | 42 |

| | |
|--|----|
| Tv Shutter-Priority AE | 44 |
| Av Aperture-Priority AE..... | 46 |
| M Manual Exposure | 48 |
| A-DEP Automatic Depth-of-Field AE..... | 50 |
| * AE Lock..... | 51 |
| Exposure Compensation | 52 |
|  Auto Exposure Bracketing (AEB) | 53 |
| Bulb Exposures | 55 |
|  Multiple Exposures | 56 |
|  Silencing the Beeper..... | 57 |
| ISO Setting the ISO Film Speed | 58 |
| Using the Remote Switch | 58 |
| 4 Flash Photography | 59 |
| Using the Built-in Flash | 60 |
| Flash Photography with a Speedlite EX-Series..... | 62 |
|  High-Speed Sync (FP Flash)..... | 64 |
| * FE Lock | 65 |
| Reference | 67 |
| Basic Photography Terms | 67 |
| Exposure Warning List | 69 |
| Feature Availability Table | 70 |
| Troubleshooting Guide | 72 |
| Major Accessories | 73 |
| Major Specifications | 75 |
| Index..... | 78 |

1

2

3

4

Reference

Handling Cautions

Camera Care and Storage

- (1) The camera is a precision instrument. Do not drop it or subject it to physical shock.
- (2) This camera is not waterproof and cannot be used underwater. If the camera gets really wet, promptly consult your nearest Canon Service Center. Wipe off any water droplets with a dry cloth. If the camera has been exposed to salty air, wipe with a well-wrung damp cloth.
- (3) Do not leave the camera in places prone to excessive heat such as in a car on a sunny day. Excessive heat can cause the camera to malfunction.
- (4) The camera contains precision electronic circuitry. Never attempt to disassemble the camera.
- (5) Use only a blower brush to blow away dust on the lens, eyepiece, mirror, focusing screen, and film compartment. Do not clean the camera body or lens with a cleaner containing an organic solvent. For stubborn dirt, consult your nearest Canon Service Center.
- (6) The shutter curtains are extremely thin. Use only a blower to clean them. Be careful not to blow air too forcefully on the shutter curtains. The shutter curtains can be easily deformed or damaged. Also, when loading and unloading film, be careful not to touch the shutter curtains.
- (7) Do not touch the electrical contacts with your fingers. Otherwise corrosion may develop on the contacts, resulting in improper camera operation.
- (8) If the camera is not to be used for an extended period, remove the battery. Store the camera in a well-ventilated, cool, dry place. During the storage period, press the shutter button to release the shutter a few times once in a while.
- (9) Avoid storing the camera in a laboratory, cabinet, etc., where corrosive chemicals are present.
- (10) If the camera has not been used for an extended period or if the camera is to be used for an important event, check the operation of all the camera controls or take it to your nearest Canon Service Center for inspection.
- (11) Even when the Main Switch is set to <OFF>, a small amount of power is still supplied to the camera's LCD panel. However, this does not affect the number of film rolls which can be taken with the battery.

LCD Displays



In time, the camera's LCD panel display and the LCD display in the viewfinder may fade and become difficult to read. If this happens, have it replaced (at cost) by a Canon Service Center.

At low temperatures, the LCD display response may become slower. And at 60°C or higher temperatures, the display may blacken. In either case, the display will return to normal at room temperature.

Lithium Batteries

- (1) The camera operates on two CR123A (or DL123A) lithium batteries. Check the battery level in the following cases (→page 16):
 - After replacing the batteries.
 - After not using the camera for an extended period.
 - The shutter stops working.
 - The camera is being used in a low-temperature environment.
 - You will be shooting an important event.
- (2) Before installing the batteries, wipe the battery contacts to remove any fingerprints and smudges. This is to prevent faulty connections and corrosion.
- (3) Never disassemble or recharge the batteries. Also, never store a battery in high-temperature places or short circuit the battery contacts or toss a battery into a fire.
- (4) Although the batteries work well even at low temperatures, battery performance may decline slightly at freezing temperatures. In such a case, keep spare batteries warm in a pocket, etc., and use and warm the batteries alternately.

How Low Battery Levels Affect Camera Operation

On the LCD panel, if the  icon blinks or it is not displayed, a proper exposure can still be obtained as long as the shutter releases. However, when the battery level is low, film advance and auto rewind might stop midway or not work at all and  may blink on the LCD panel. After the batteries are replaced with new ones, film advance will be possible and film rewind will resume when you press the  button for at least 1 sec.

Lens Electrical Contacts

After detaching the lens from the camera, put on the lens caps or put down the lens with the rear end up to avoid scratching the lens surface and electrical contacts.

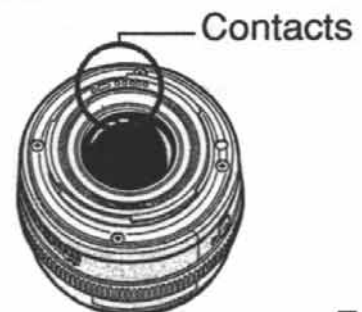

Quick Start Guide

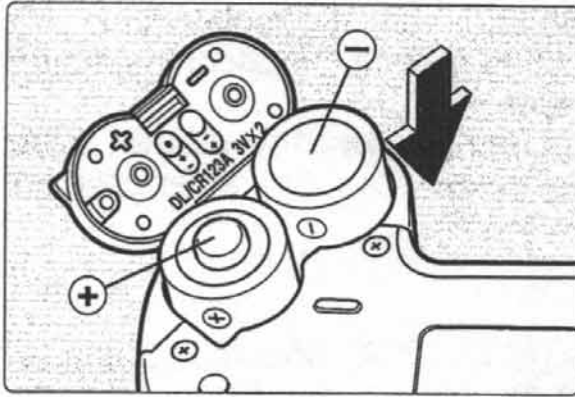

1 **Install the batteries.**
Insert two CR123A (or DL123A) lithium batteries as shown by the battery orientation diagram on the battery compartment cover. (→page 16)

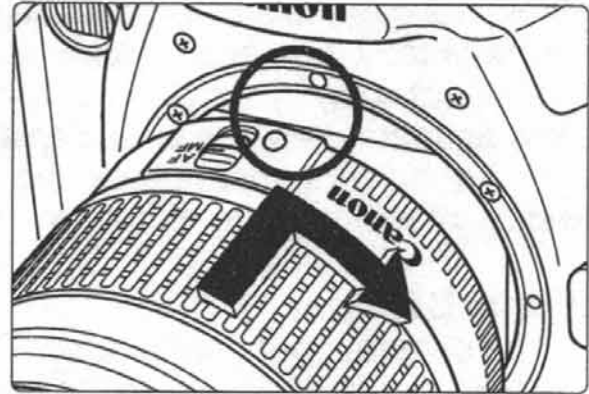

2 **Attach a lens.**
Align the red dots on the lens and camera and turn the lens as shown by the arrow until it snaps in place. (→page 18)

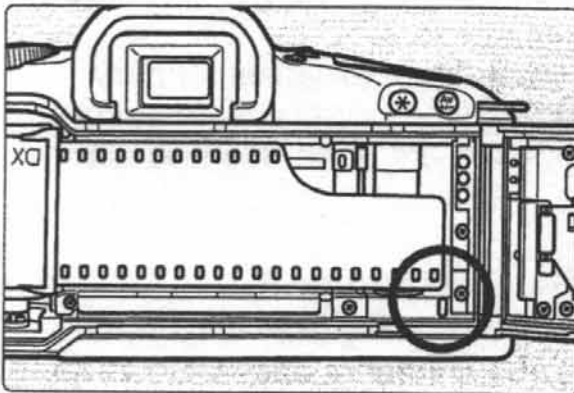

5 **Load the film.**
Align the edge of the film leader with the orange mark on the camera and close the camera back until it snaps shut. (→page 20)
• The film will then advance to the first frame automatically.



6 **Focus the subject.**
Aim the AF frame on the subject and press the shutter button halfway to autofocus. (→page 19)
• If the <⚡> icon blinks, pop up the built-in flash. (→page 60)

Nomenclature

- The reference page is indicated in parentheses.
- The camera controls are indicated as icons in brackets < >.

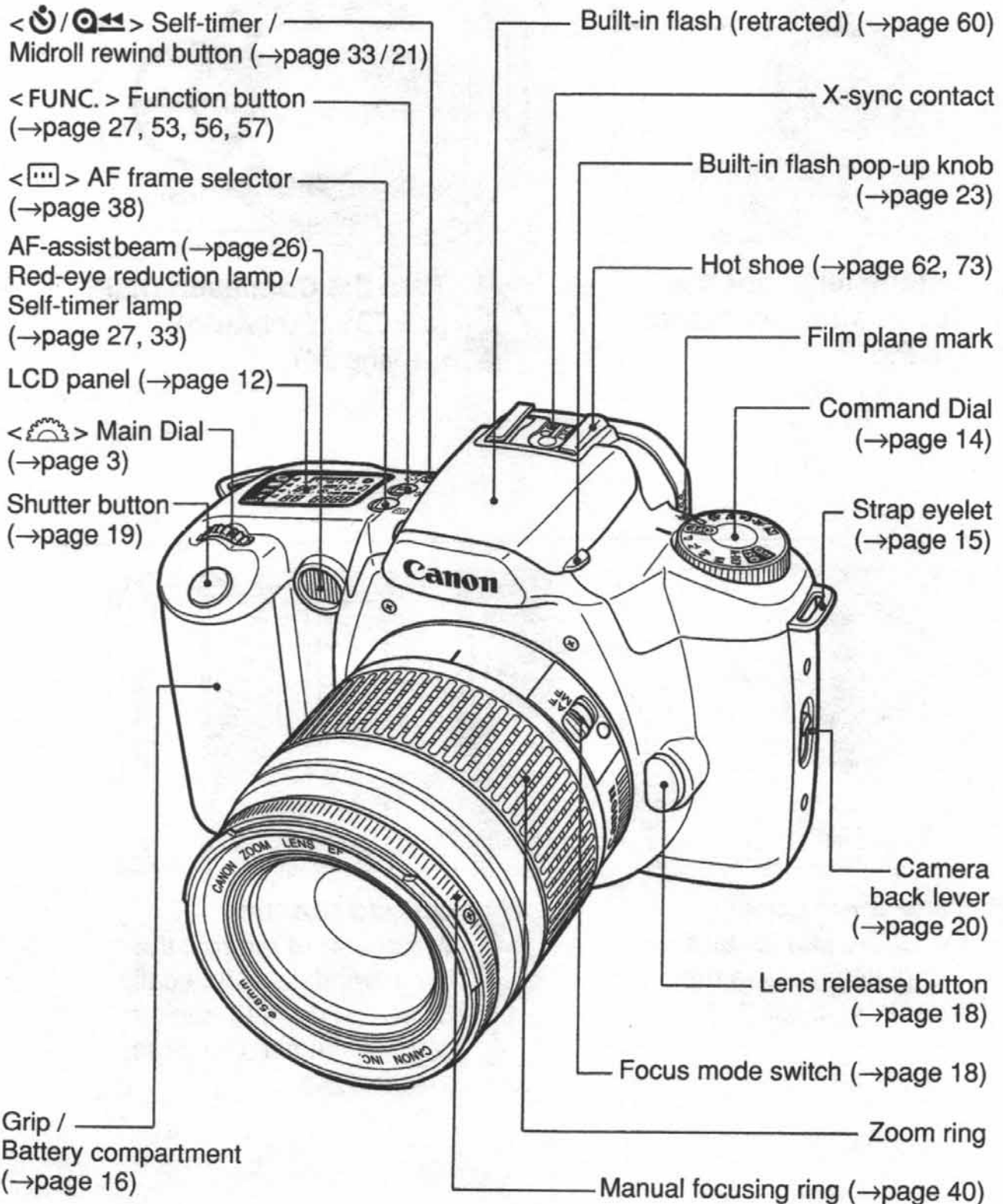

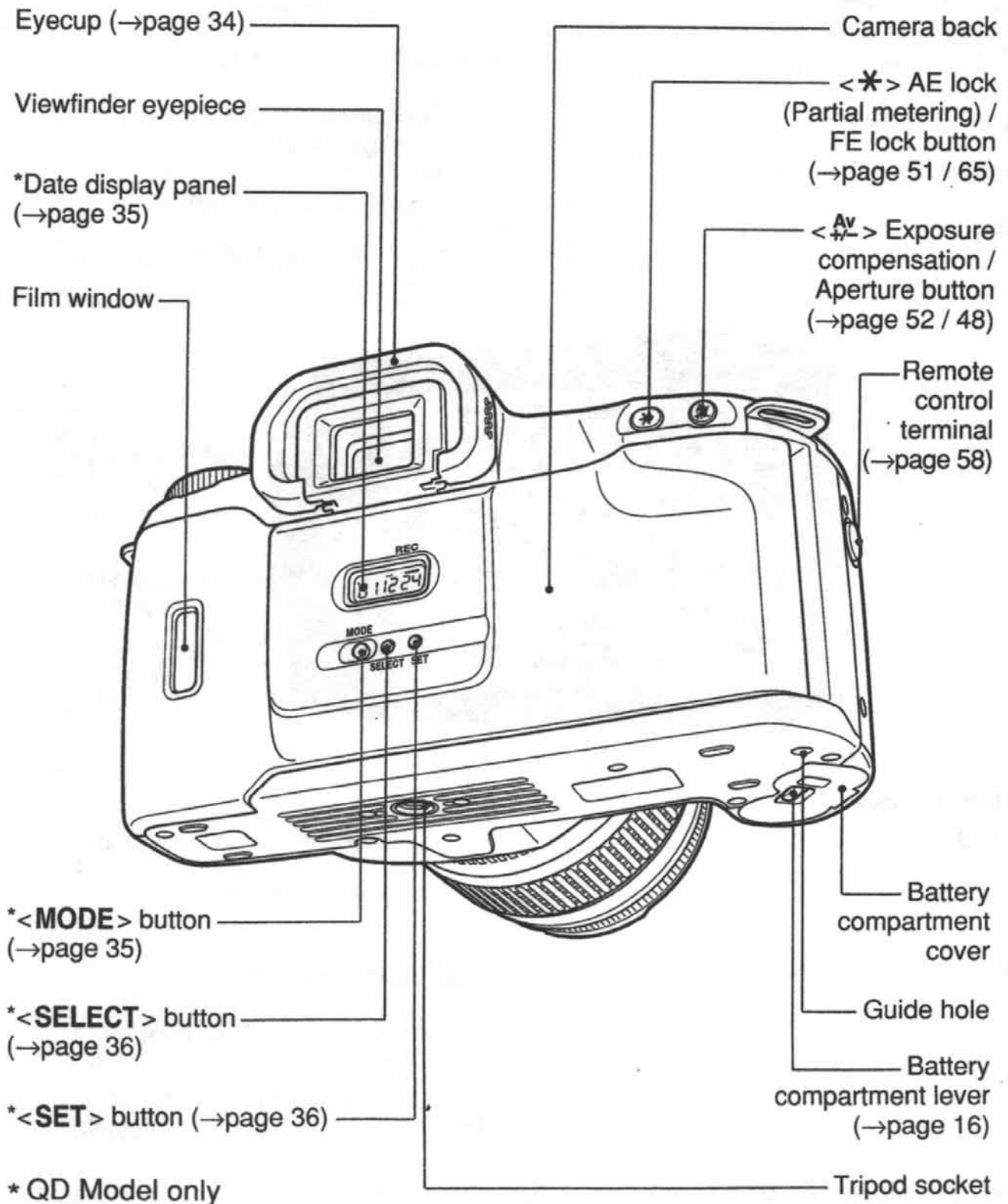

LCD Panel

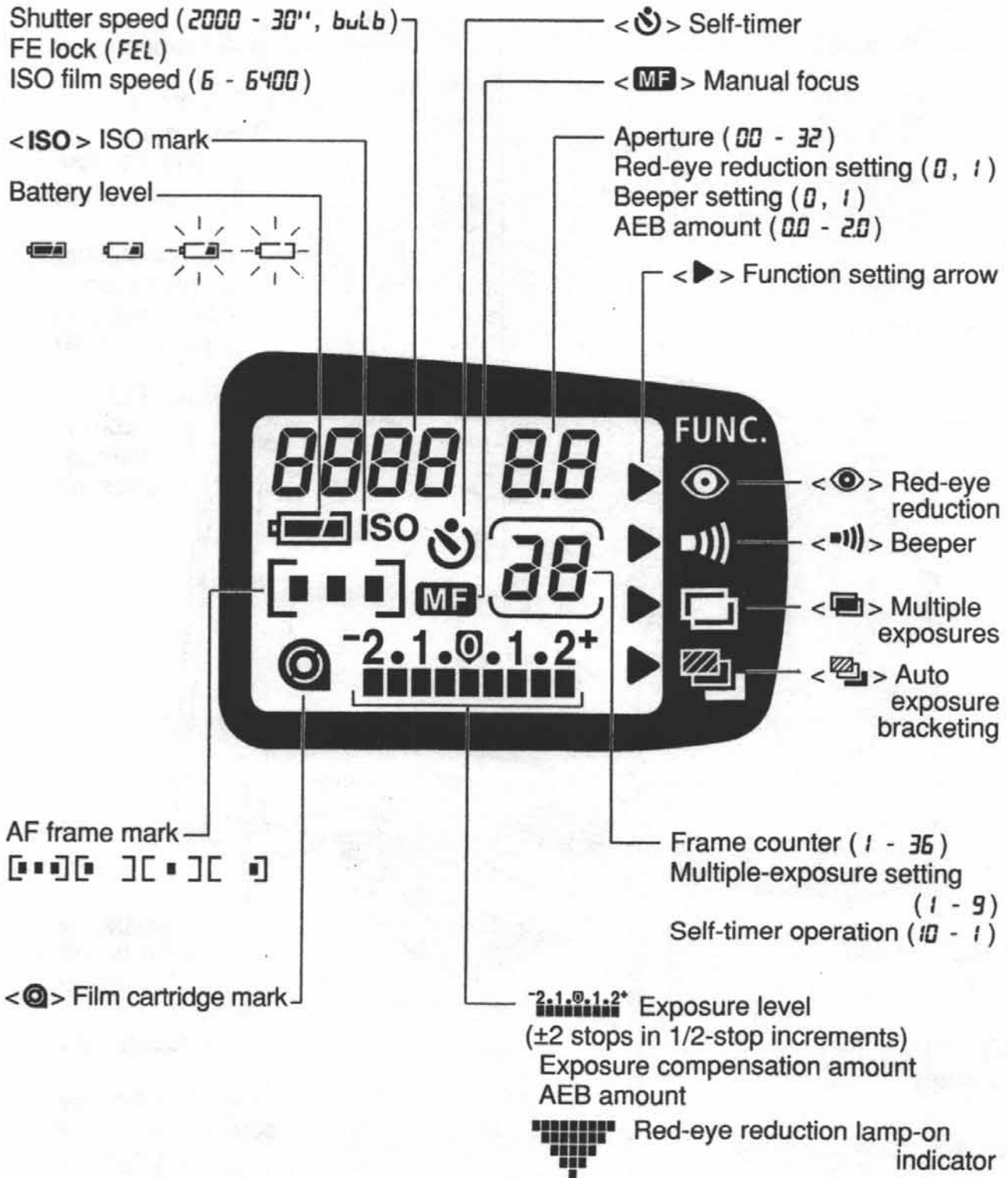

• The <▶> arrow is displayed next to the function being set.

Viewfinder Information

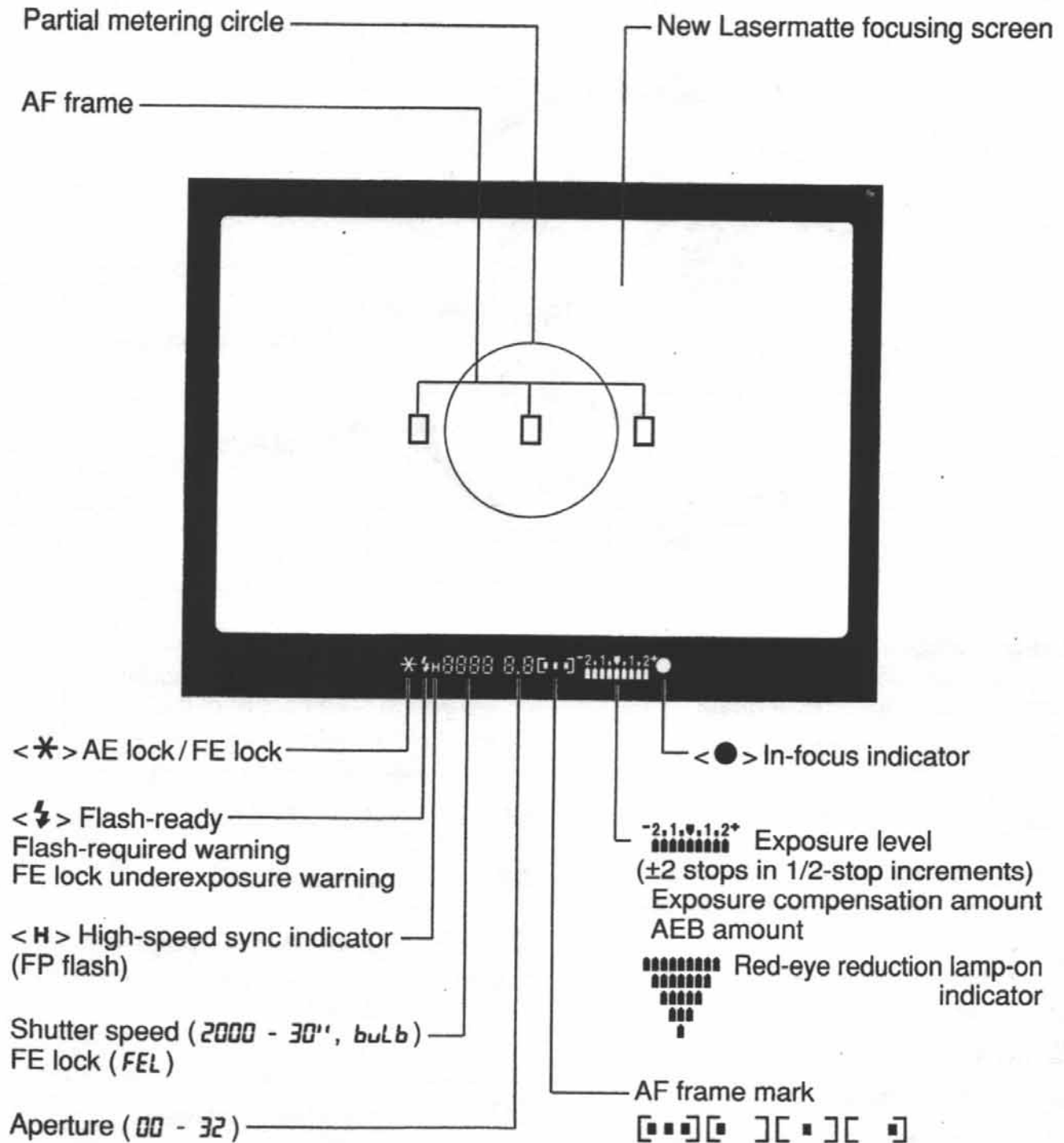

• On pages 12 and 13, all the display items are shown for explanatory purposes. During actual operation, only some of the items are displayed.

Command Dial

The dial is divided into four zones.

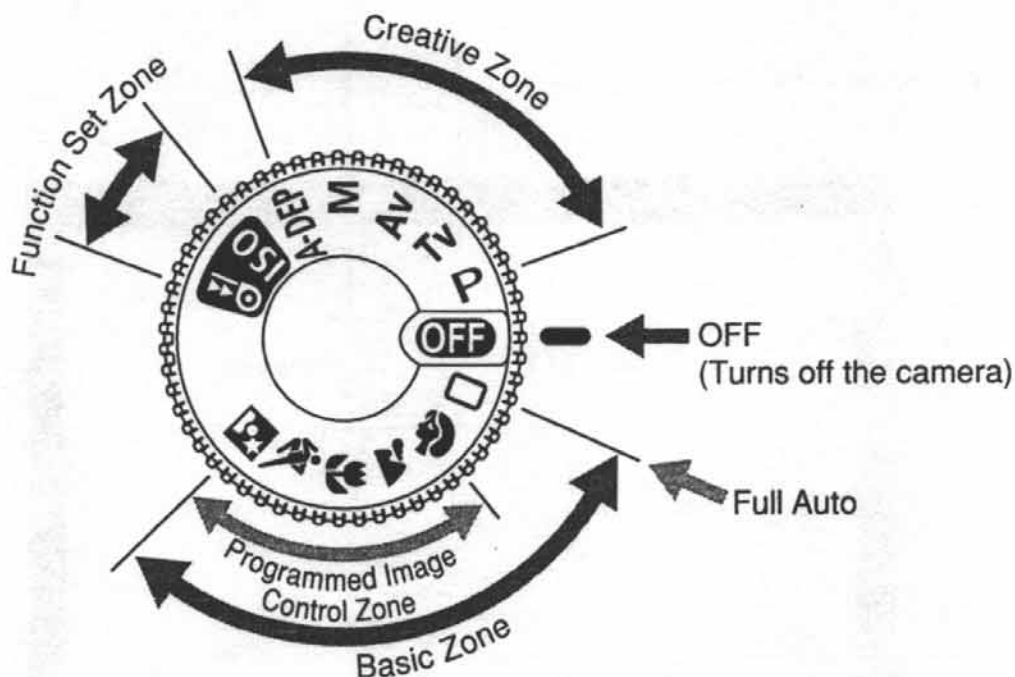

① Basic Zone

Fully automatic mode where the camera takes care of everything.

: **Full Auto** (→page 24)

Basically, all you do is point and press the shutter button.

Programmed Image Control Zone

Fully automatic modes for a particular subject.

: Portrait (→page 28)

: Landscape (→page 29)

: Close-up (→page 30)

: Sports (→page 31)

: Night Scene Portrait (→page 32)

② Creative Zone

Semi-automatic and manual modes enable you to take control of the camera to obtain the desired result.

P : Program AE (→page 42)

Tv : Shutter-priority AE
(→page 44)

Av : Aperture-priority AE
(→page 46)

M : Manual exposure (→page 48)

A-DEP : Automatic Depth-of-field AE
(→page 50)

③ Function Set Zone

ISO : Manual ISO speed setting
(→page 58)

: Midroll film rewind (→page 21)

④ OFF : Off

This chapter explains the things you need to know and do before you use your camera for the first time.



Before You Start

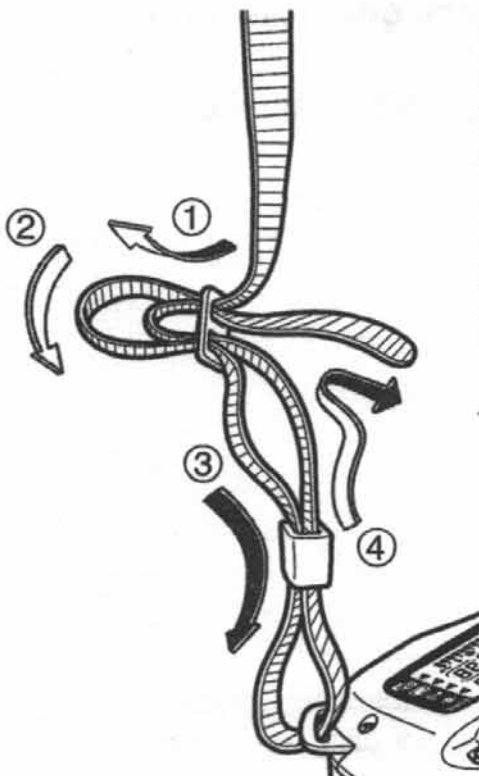

Attaching the Strap

Pass the end of the strap through the camera's strap eyelet from the bottom. Then pass it through the strap's clasps as shown in the illustration. Pull the strap to make sure it does not slip out of the clasp.

- The eyepiece cover is also attached to the strap. (→page 34)

Installing the Batteries and Checking the Battery Level

Installing the Batteries

The camera uses two lithium CR123A (or DL123A) batteries.

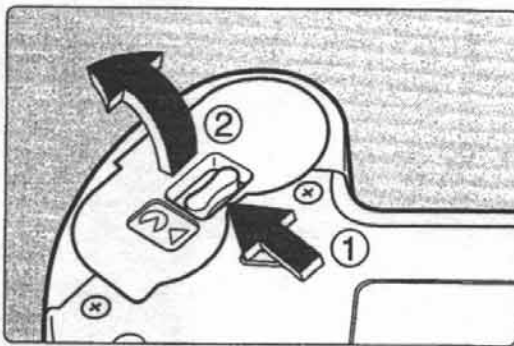

1 Open the battery compartment cover.

- Slide cover release lever as shown by the arrow and open the battery compartment cover.

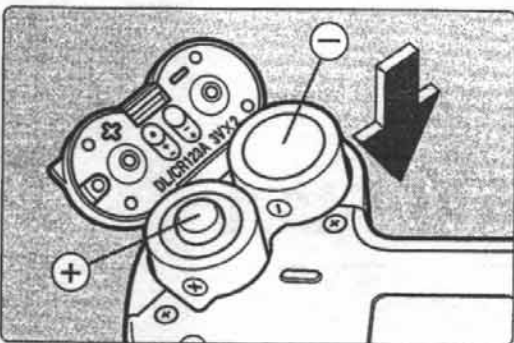

2 Insert the batteries.

- Make sure the battery contacts (+ and -) are oriented as shown on the battery compartment cover.
- Do not mix old and new batteries.

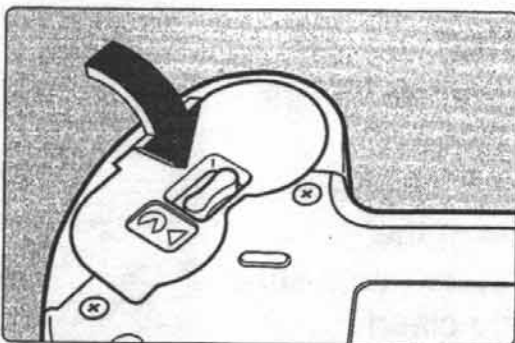

3 Close the battery compartment cover.

- Press the cover until it snaps shut.

 For places where CR123A batteries may not be easily available, take spare batteries with you. Also carry spare batteries for extended shooting sessions.



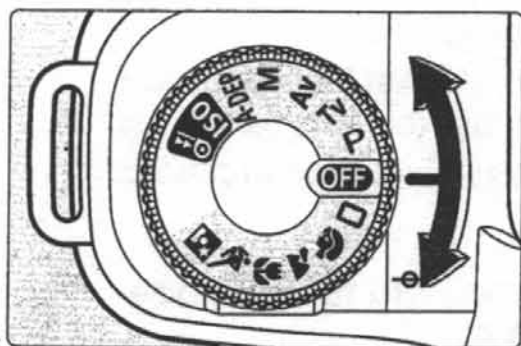

Checking the Battery Level

Check the battery level after replacing the batteries and before using the camera.



Turn the Command Dial to a shooting mode.

- The camera will then turn on and the LCD panel will display one of the following battery level icons:

-  : Battery level OK.
-  : The battery level is low. Keep spare batteries handy.
-  : The batteries will soon be completely exhausted.
-  : Replace the batteries. (→page 7)

Battery Life

(With 24-ex. rolls)

| Temperature | 0% Flash Use | 50% Flash Use | 100% Flash Use |
|-------------|--------------|---------------|----------------|
| At 20°C | 85 rolls | 35 rolls | 17 rolls |
| At -10°C | 60 rolls | 25 rolls | 12 rolls |

- The Battery Life table above is based on Canon's testing conditions using an EF 50mm f/1.4 USM lens and new batteries.

- If nothing is displayed on the LCD panel, the batteries may have been installed incorrectly. Take out the batteries and install correctly. (→page 16)
- Pressing the shutter button halfway for a prolonged period or operating only the autofocus without taking a picture will still consume battery power. It will reduce the number of rolls that can be taken with the batteries.

 When not using the camera, set the Command Dial to < **OFF** >.

Mounting and Detaching a Lens

Mounting a Lens

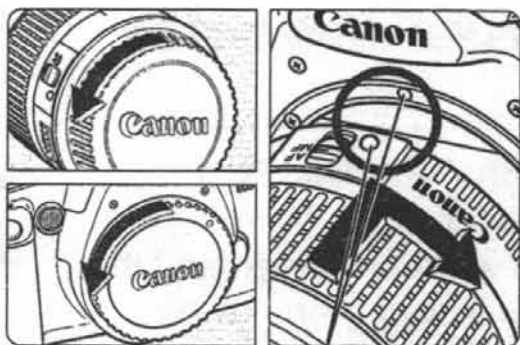

Red dots

1 Remove the caps.

- Remove the rear lens cap and the camera body cap.

2 Mount the lens.

- Align the red dots on the lens and camera and turn the lens as shown by the arrow until it snaps in place.

3 On the lens, set the focus mode switch to <AF>.

- If the focus mode switch is set to <MF> (or <M> on older lenses), autofocus will not operate and <MF> will be displayed on the LCD panel.

4 Remove the front lens cap.

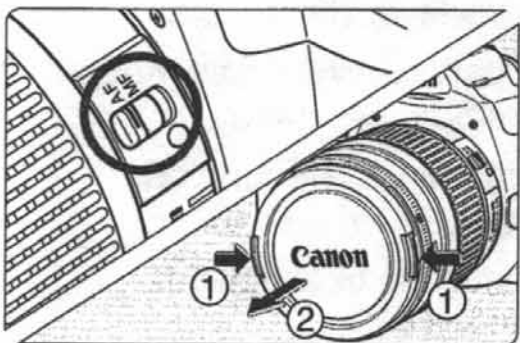

Detaching the Lens

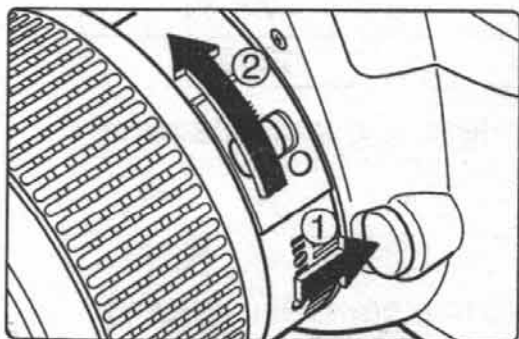

While pressing the lens release button, turn the lens as shown by the arrow.

- When the red dot on the lens is at the top, remove the lens.



- Keep the removed caps where you will not lose them.
- An EF-S lens cannot be attached to the camera.
- “AF” stands for Autofocus.
- “MF” (or “M”) stands for Manual Focus.

How the Shutter Button Works

The EOS camera's shutter button can be depressed halfway or all the way. There is a click stop at the halfway point.

Pressing the Shutter Button Halfway or Completely

The shutter button works as described below.

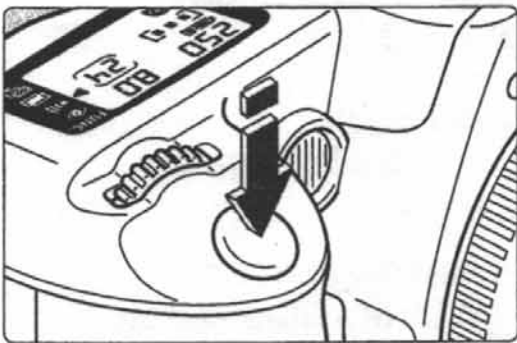

When it is pressed halfway:

- Autofocusing is activated, and when focus is achieved, the beeper sounds and the in-focus indicator <●> on the viewfinder's lower right also lights.
- Also, the shutter speed and aperture are set and displayed on the LCD panel and in the viewfinder.

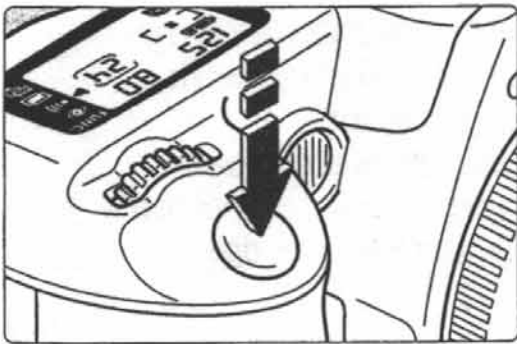

When it is pressed completely:

- The shutter is released to take the picture and the film advances by one frame.

❗ If an Extender is used and the maximum aperture of the lens becomes smaller than f/5.6 (larger f-number), autofocusing will not operate.

📖 Camera movement during the moment of exposure is called camera shake. Camera shake can cause blurred pictures. To prevent blurred pictures due to camera shake:

- Hold the camera steady (→page 22).
- Use the center of your finger to touch the shutter button, grasp the camera with your entire right hand, then press the shutter button gently.

📷 Loading and Unloading Film

Loading Film

After you load the film, the camera first winds the entire roll onto the camera's take-up spool. With DX-coded film, the camera automatically sets the film's ISO speed. Then each time a picture is taken, one frame of film is rewound back into the film cartridge.

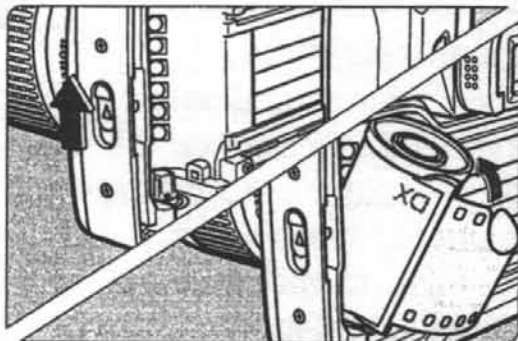

Right

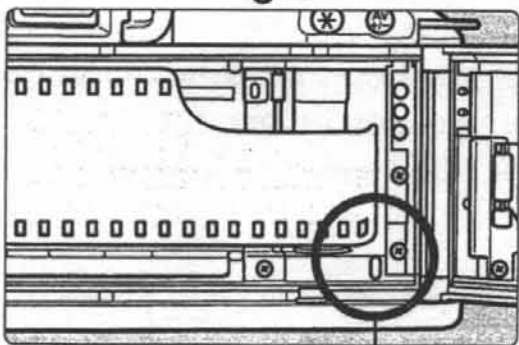

Orange mark

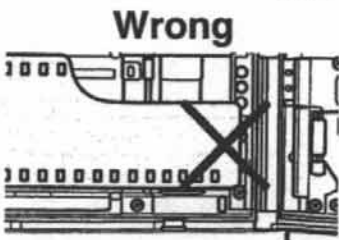

Wrong

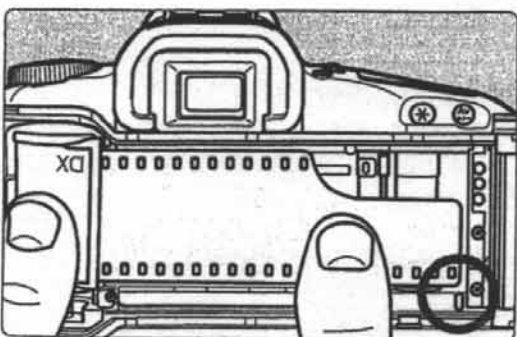

- 1 Turn the Command Dial to any setting except <OFF>.**
- 2 Open the camera back.**
 - Slide the camera back lever up as shown by the arrow.
- 3 Insert the film cartridge at an angle as shown in the illustration.**

- 4 Pull the edge of the film leader to the orange mark on the camera.**
 - Hold down the film cartridge while pulling out the film leader.
 - If the edge of the film leader goes beyond the orange mark, rewind some of the film back into the cartridge.

- 5 Close the camera back.**
 - After checking that the film leader edge is correctly aligned with the orange mark, close the camera back.
 - After you close the camera back, the film will start winding on the take-up spool and the frame counter will count up. The camera will then make a shutter-release sound and the <📷> icon and total frame count will be displayed.
 - During the film's prewind, the ISO speed is displayed on the LCD panel.

- In hot and humid environments, do not remove the film packaging until you are ready to load the film
 - The shutter curtains have been manufactured at very high precision. Never touch them with your fingers. When loading film, do not touch or damage the curtains with your fingers or film.
-  • If the film is not loaded properly, the <Ⓞ> icon will blink on the LCD panel and the shutter will not work. Reload the film cartridge properly. (→page 20)
- If the film is not DX-coded, set the ISO speed manually. (→page 58)
 - Infrared film cannot be used with this camera.

Unloading Film

After the film's last frame is exposed, the camera rewinds the film automatically.

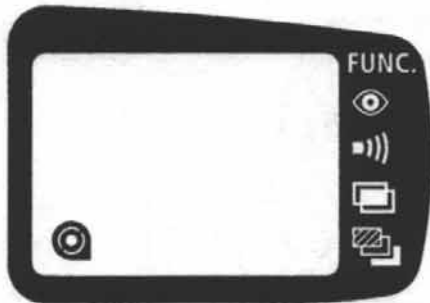

After the film's last frame is exposed, the camera rewinds the film automatically. There will be a shutter-release sound and then only the <Ⓞ> icon will be displayed on the LCD panel. Make sure this icon is displayed, then open the camera back and unload the film.

Ⓞ Midroll Rewind

To rewind the film in midroll, follow the procedure below.

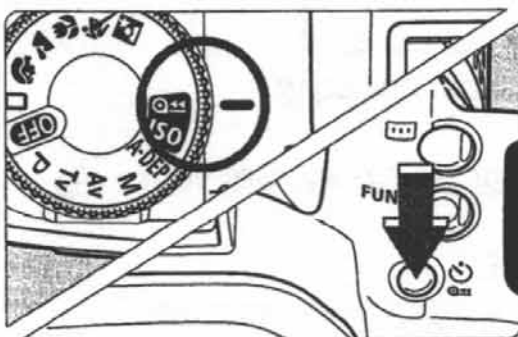

- 1 Turn the Command Dial to <Ⓞ>.**
- 2 Press and hold down the <Ⓞ> button for at least 1 second.**
 - The film will start rewinding. When the film rewind ends, there will be a shutter-release sound.
- 3 Open the camera back and remove the film.**

Ⓞ Loading and Unloading Film / Holding the Camera

- ❗ If you remove the film from the camera in midroll without rewinding and then load a new roll of film, the new roll's film leader will only be rewound into the film cartridge. To prevent this, close the camera back and press the shutter button completely before loading a new roll of film.

Holding the Camera

To avoid taking a blurred shot, hold the camera properly as described below.

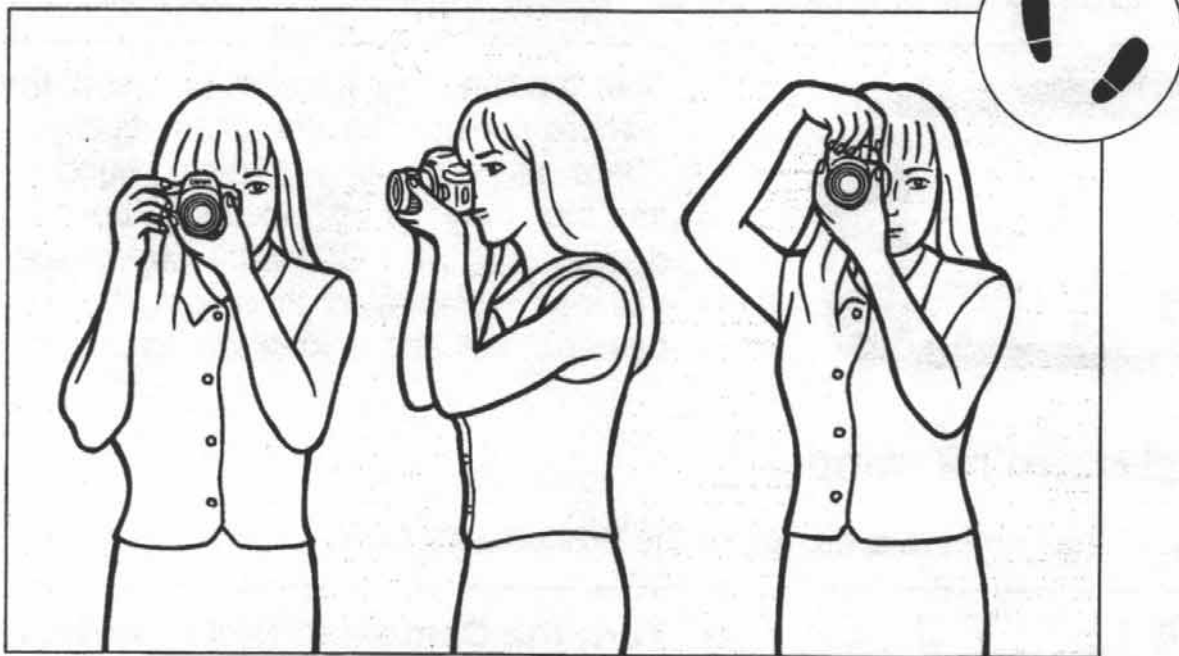

Horizontal shooting

Vertical shooting

- Wrap your right hand around the camera grip and grasp firmly. Set your elbow lightly against your body.
- Use your left hand to hold the lens from underneath.
- Press the camera against your forehead and look through the viewfinder.
- Keep one foot slightly ahead of the other for better stability.



For quick and easy picture-taking, this section describes the Command Dial's Basic Zone modes: <□>, <☹>, <☹>, <☹>, <☹>, and <☹>. Each one of these modes set all the camera settings automatically. All you do is point the camera and press the shutter button. Also, these modes disable the camera's <☹> dial and buttons (except <☹>, <☹>, and <☹>). This is to prevent spoiled shots caused by accidental operation of these camera controls.

Fully Automatic Shooting

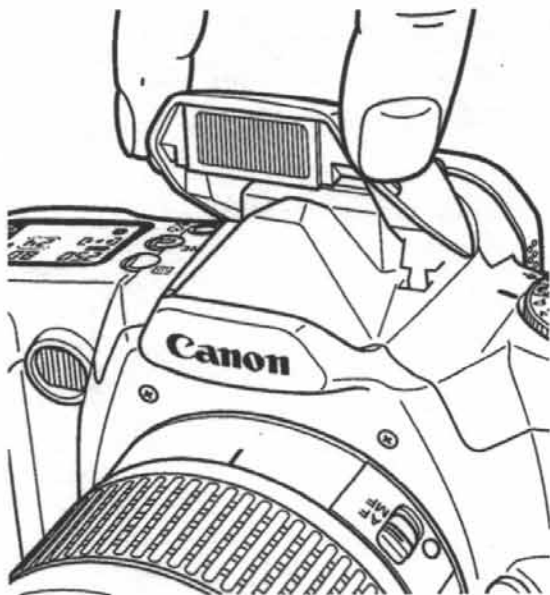

- In a Basic Zone mode, if the <☹> icon lights, pop-up the built-in flash with your fingers. If you pop-up the built- flash beforehand, it will fire automatically under low-light or backlit conditions.
- The settings automatically set by the Basic Zone modes are shown in the "Feature Availability Table" on page 70.

Full Auto Mode

All you do is point the camera and press the shutter button. Everything is automatic so it is easy to photograph any subject. With three focusing points to focus the subject, anyone can just point and shoot.

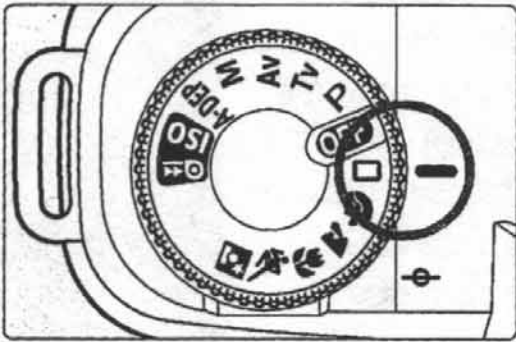

1 Turn the Command Dial to .

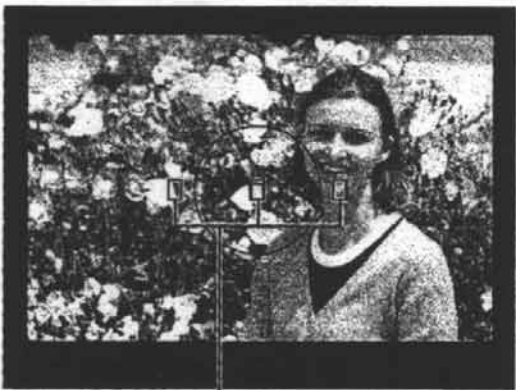

AF Frame

2 Aim any of the focusing points on the subject.

- ▶ The main subject, as determined by the camera, will be focused by one of the focusing points.
- To focus a subject not covered by any of the focusing points, see “Focusing Off-Center Subjects” on page 39.

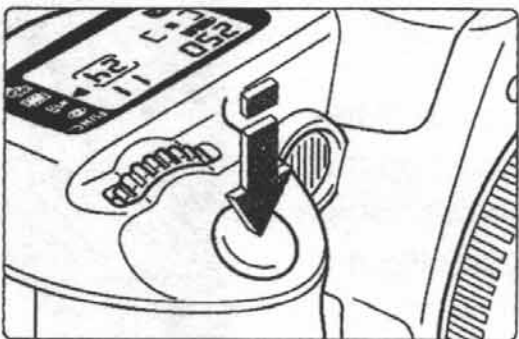

3 Press the shutter button halfway to focus.

- ▶ When focus is achieved, the beeper will sound and the in-focus indicator  in the viewfinder's lower right will light.
- ▶ The focusing point which achieved focus will also light.

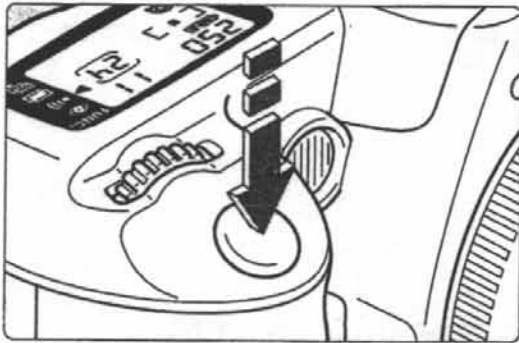

4 Check the exposure setting.

- The shutter speed and aperture will be set automatically and displayed in the viewfinder and on the LCD panel.
- If the <⚡> icon blinks in the viewfinder in low-light or backlit conditions, pop up the built-in flash. (→page 60)

5 Take the picture.

- Compose the shot and press the shutter button completely.

- ☑ • When focus is achieved, the autofocus and auto exposure setting will also be locked.
- If the in-focus indicator <●> blinks, the picture cannot be taken. (→pages 40)
- Out of the three focusing points, usually the one covering the closest subject is selected automatically to achieve focus.
- Multiple focusing points may light simultaneously. This indicates that these focusing points have all achieved focus.

- 💡 If you pop-up the built-in flash (→page 60) beforehand, it will fire automatically under low-light or backlit conditions.

Full Auto Mode

Built-in Flash

In the Basic Zone modes, if you pop-up the built-flash beforehand, it will fire automatically under low-light or backlit conditions. In the Creative Zone modes, you can pop up the built-in flash and fire the flash at any time regardless of the ambient light level. To retract the flash head, push it down by hand.

For details, see “Using the Built-in Flash” on page 60.

 In the and modes, the built-in flash will not fire.

AF-Assist Beam

When the camera has difficulty focusing, the AF-assist beam illuminates the subject to aid focusing. The AF-assist beam operates in the Basic Zone and Creative Zone modes.

-  • The AF-assist beam is effective up to about 4 meters.
- If an EOS-dedicated, external Speedlite (sold separately) is attached to the camera, the Speedlite's built-in AF-assist lamp will light instead.
- The AF-assist beam operates in the Basic Zone and Creative Zone modes.
- If the camera has difficulty focusing the subject, the AF-assist beam will be emitted by the camera or external, EOS-dedicated Speedlite.

Single-frame and Continuous Shooting

The film advance mode (single or continuous) when the shutter button is held down is set automatically by the respective shooting mode.

The film advance mode set by the respective shooting mode is shown in the “Feature Availability Table” on page 70.

👁 Using Red-eye Reduction

When flash is used in a low-light environment, the subject's eyes may come out red in the photograph. "Red eye" happens when the light from the flash reflects off the retina of the eyes.

The camera's red-eye reduction feature turns on the red-eye reduction lamp to shine a gentle light into the subject's eyes to narrow the pupil diameter or iris. A smaller pupil reduces the chances of red eye from occurring. Red-eye reduction can be set in any shooting mode except <📷> and <📷>.

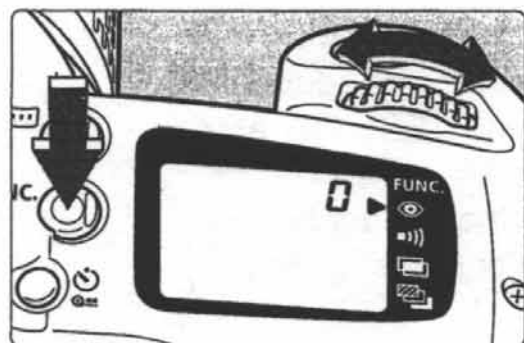

1 Move the <▶> arrow to the <👁> icon on the LCD panel.

- Look at the LCD panel and press the <FUNC.> button to move the arrow. (06)



2 Turn the <🔧> dial to set "!" on the LCD panel.

- Press the shutter button halfway to return to normal camera operation.
- When red-eye reduction is enabled, the red-eye reduction lamp-on indicator will be displayed in the viewfinder and on the LCD panel when you press the shutter button halfway and the lamp lights.
- To cancel red-eye reduction, set "0" on the LCD panel.

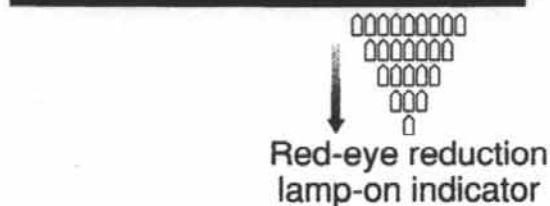

- 📷 • Red-eye reduction will not work unless the subject looks at the red-eye reduction lamp. Tell the subject to look at the lamp.
- For maximum effectiveness, take the picture after the red-eye reduction lamp turns off (after 1.5 sec.).
- You can take a picture even while the red-eye reduction lamp is lit.
- The effectiveness of red-eye reduction varies depending on the subject.

💡 To further increase the effectiveness of red-eye reduction, go to a brighter environment or move closer to the subject.

Portrait Mode



This mode blurs the background to make the human subject stand out.

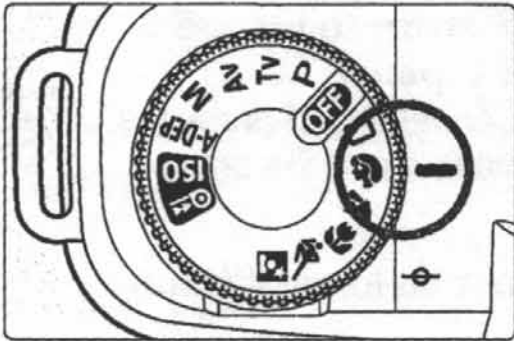

Turn the Command Dial to .

- The picture-taking procedure is the same as with the Full Auto mode on page 24.
- Holding down the shutter button executes continuous shooting.

-  • Background blur is most effective when the subject fills the frame from the waist up. Also, the further away the subject is from the background, the more blurred the background will become.
- Using a telephoto lens also increases background blur. If you have a zoom lens, use the longest focal length. (For example, a 28-80mm zoom lens set to 80mm.)
- If you pop-up the built-flash (→page 26, 60) beforehand, it will fire automatically under low-light or backlit conditions.

Landscape Mode



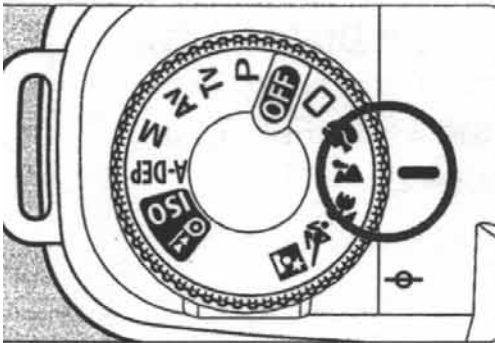

This is for sweeping scenery, night scenes, etc.



Turn the Command Dial to .

- The picture-taking procedure is the same as with the Full Auto mode on page 24.

 If the shutter speed display blinks, the shutter speed may be too slow and a blurred picture may result due to camera shake. Using a tripod is recommended. (The shutter speed will still blink even while a tripod is used.)

 Even if the built-in flash has been popped up, it will not fire.

 Using a wide-angle lens will further enhance the depth and breadth of the picture. If you have a zoom lens, use the shortest focal length. (For example, a 28-80mm zoom lens set to 28mm.)

Close-up Mode



Use this mode to take close-up shots of flowers, insects, etc.

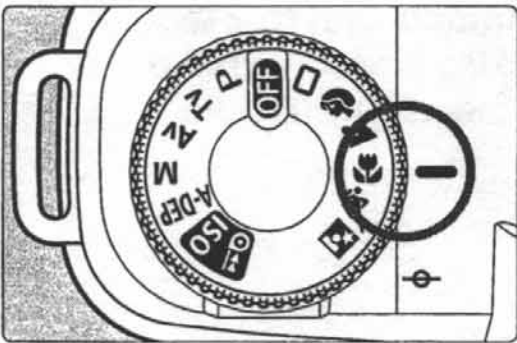

Turn the **Command Dial** to **<🌸>**.

- The picture-taking procedure is the same as with the **<☐>** Full Auto mode on page 24.

- 💡 • As much as possible, focus the subject at the lens' closest focusing distance.
- If you have a zoom lens, use the maximum focal length to obtain a larger magnification.
- For better close-ups, an EOS-dedicated macro lens and Macro Ring Lite (both optional) are recommended.
- If you pop-up the built-flash (→page 26, 60) beforehand, it will fire automatically under low-light or backlit conditions.

Sports Mode

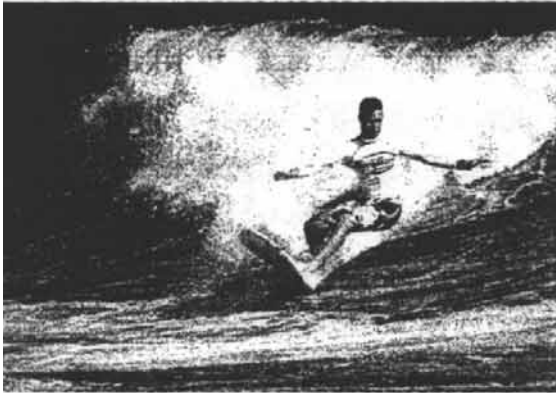

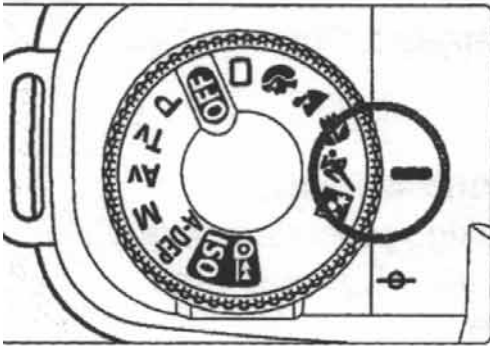

This is for sports and fast-moving subjects when you want to freeze the action on film.



Turn the Command Dial to .

- The picture-taking procedure is the same as with the Full Auto mode on page 24.
- Holding down the shutter button executes continuous focusing and shooting.

 If the shutter speed display blinks, the shutter speed may be too slow and a blurred picture may result due to camera shake. Using a tripod is recommended. (The shutter speed will still blink even while a tripod is used.)

 Even if the built-in flash has been popped up, it will not fire.

- Using ISO 400 or faster film is recommended.
- For sports photography, a lens with a focal length of 200 mm or 300 mm is recommended.

Night Scene Portrait Mode



This mode is for taking pictures of people at twilight or at night. The flash illuminates the subject while a slow sync speed obtains a natural-looking exposure of the background.

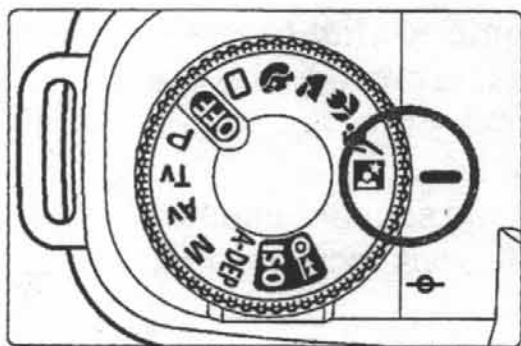



1





Turn the Command Dial to .

2

Pop up the built-in flash.

- The picture-taking procedure is the same as with the  Full Auto mode on page 24.

 To prevent camera shake, using a tripod is recommended.

-  • If you want to photograph only a night scene (without people), use the  mode instead.
- Tell the subject to keep still even after the flash fires.
- If you use the self-timer in this mode, the red-eye reduction lamp will flash when the exposure is completed.
- The  mode can be used even while an EOS-dedicated Speedlite is attached to the camera.
- If the  mode is set in daylight, it will function in the same way as the  mode.

 Using ISO 400 or faster film is recommended.

Using the Self-timer

The self-timer is for when you want to be in the picture. It can be used in Basic Zone and Creative Zone modes. You should also use a tripod.

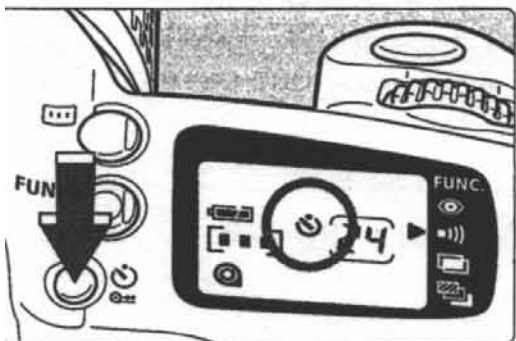



1 Press the self-timer button </Q<>.

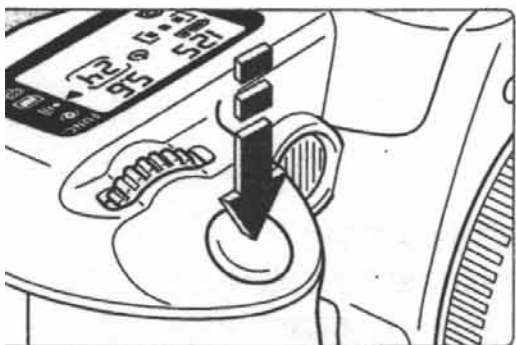

- The <> icon will be displayed on the LCD panel.
- To cancel the self-timer, press the self-timer button </Q<> again or turn the Command Dial to <**OFF**>.



2 Take the picture.

- The picture-taking procedure is the same as with the <> Full Auto mode on page 24.
- Look through the viewfinder and press the shutter button completely to start the self-timer.
- ▶ When you press the shutter button completely, the beeper will sound and the picture will be taken 10 sec. later. During the first 8 seconds, the beeper beeps slowly. During the final 2 seconds, the beeper beeps faster and the self-timer lamp lights.
- ▶ Also, the self-timer display on the LCD panel counts down in seconds.

 Do not stand in front of the camera when you start the self-timer. Doing so will throw off the focus.

-  • To cancel the self-timer after it starts, press the </Q<> button again.
- When using the self-timer to take a picture of only yourself, first lock the focus (→page 39) on an object at the same distance where you will be in the picture.

Using the Eyepiece Cover

If you use the self-timer or Remote Switch (optional) and take a picture without looking through the viewfinder, stray light may enter the eyepiece and affect the exposure. To prevent this, attach the eyepiece cover on the eyepiece before taking the picture.

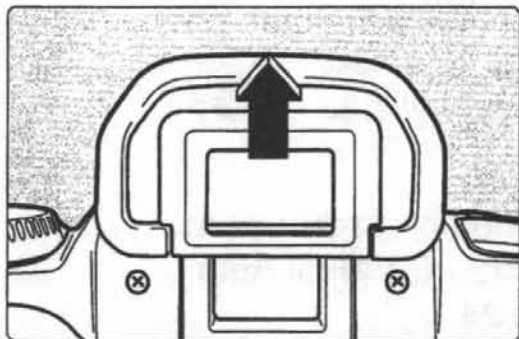

1 Remove the eyecup from the eyepiece.

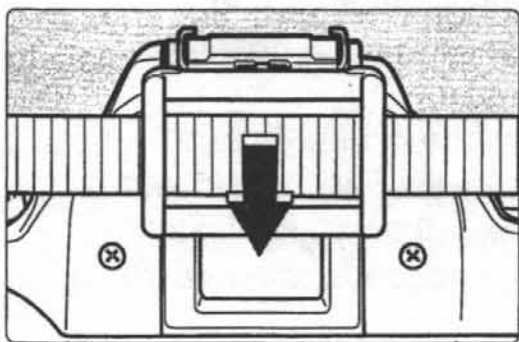

2 Attach the eyepiece cover.
• Slide the eyepiece cover down into the eyepiece groove to attach it.

Imprinting the Date or Time (QD Model only) ■■■■



The date or time is imprinted on the lower right corner of the photograph.

The camera has a quartz date feature which maintains an automatic calendar up to the year 2019. It can imprint the date or time on the photograph as shown in the left photo. The imprinting can also be disabled so nothing is imprinted. The date or time can be imprinted in any shooting mode.

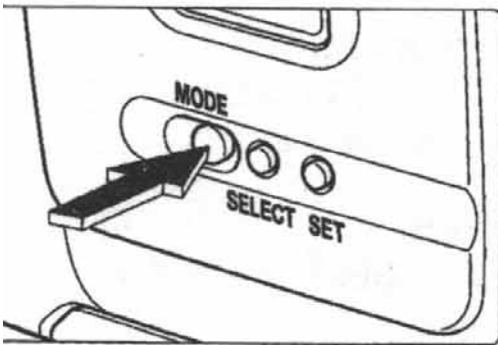

Press the <MODE> button.

- ▶ Each time the button is pressed, the imprinting format changes in the following sequence as shown on the Date display panel:

| | | |
|-------------------|-------------------------------------|-----------------|
| Year, month, day | '01 ^M 12 [—] 24 | (2001 Dec. 24) |
| ↓ | | |
| Day, hour, minute | 24 16:45 | (24th 16:45) |
| ↓ | | |
| Blanks | - - - - - | (Blank) |
| ↓ | | |
| Month, day, year | ^M 12 24 '01 | (Dec. 24, 2001) |
| ↓ | | |
| Day, month, year | 24 ^M 12 '01 | (24 Dec. 2001) |

<M> is displayed above the month.

The <—> bar above the last two digits is the imprint indicator. It blinks to indicate that the date or time is being imprinted when the picture is taken.

Setting the Date and Time

To set the date or time, follow the procedure below.



1 Select the date or time display.

- Press the <MODE> button.



2 Select the digit to be set.

- Press the <SELECT> button until the digit blinks.



3 Set the correct number.

- Keep pressing the <SET> button until the correct number appears.



4 Finalize the setting.

- Keep pressing the <SELECT> button until no digits blink.

Replacing the Quartz Date Back's Battery

When the date/time on the imprinted photograph looks faded, replace the CR2025 lithium battery as follows. Battery life is about 3 years.

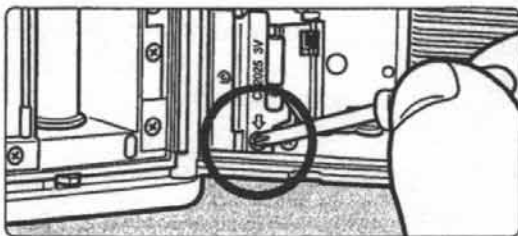

1 Remove the battery compartment cover.

- Open the camera back and loosen the screw as shown in the illustration.

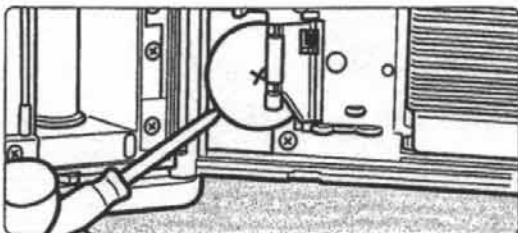

2 Take out the battery.

3 Insert a new battery.

- The battery's positive contact (+) must face up.

4 Reattach the battery compartment cover.

- Set the correct date and time.

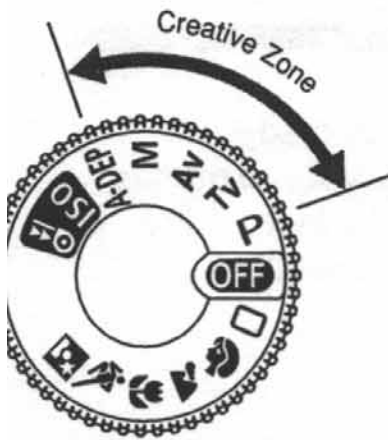

The Creative Zone modes enable you to control the camera to obtain the effect you want. Shutter-priority, aperture-priority, and other user-controllable modes are provided. The Creative Zone modes (<P>, <Tv>, <Av>, <M>, and <A-DEP>) are described here along with other advanced operations.

3

User-Controlled Shooting

In the text, the  icon indicates the Main Dial.

Even after you press the shutter button halfway and let go of the button, the shutter speed and aperture will remain displayed on the LCD panel and in the viewfinder for about 4 sec. (ⓘ4)

The following features work in the Creative Zone modes: AE lock, exposure compensation, AEB, and multiple exposures. The settings automatically set in the respective Creative Zone mode are shown in the "Feature Availability Table" on page 70.

Selecting an AF Frame

The AF frame is used for focusing. The AF frame can be selected automatically by the camera or manually by you. In the Basic Zone modes and <A-DEP> mode, the AF frame selection is automatic only. In the <P>, <Tv>, <Av>, and <M> modes, the AF frame can be selected either automatically or manually.



Automatic AF Frame Selection

The camera selects the AF frame automatically. Suited for snapshots.

Manual AF Frame Selection

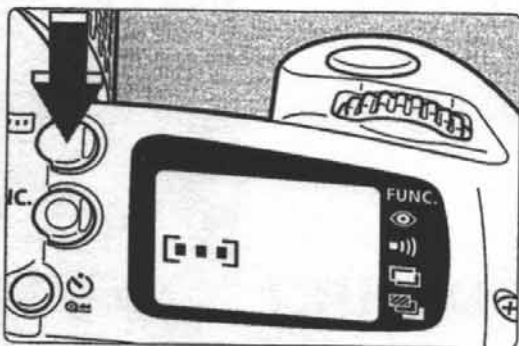
You can select any one of the three AF frames to achieve focus. It is convenient when you want to make sure the target subject is focused or when you want to retain the off-center framing of the subject.



- 1** Press the  button. ()
- The AF frame currently selected is displayed.

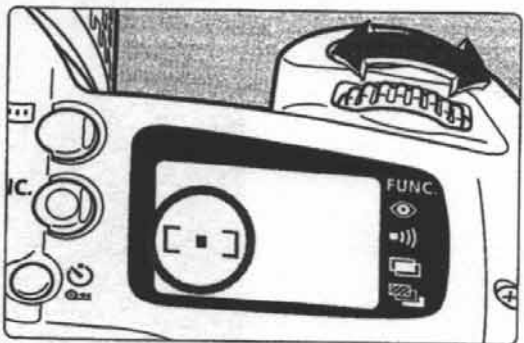

- 2** Turn the  dial to select the desired AF frame. When the dial is turned, the AF frame selection shifts in the loop shown below:

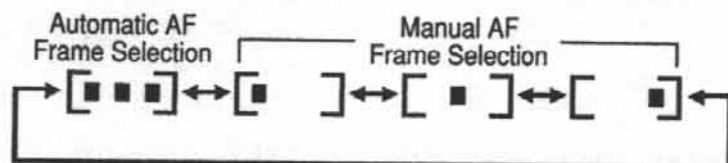

- Press the shutter button halfway to focus with the selected AF frame.

Focusing Off-Center Subjects

you want to focus an off-center subject not covered by any of the AF frames, use focus lock as described below.

1 Select the desired AF frame.
(→page 38)



2 Focus the subject.
• Aim the AF frame on the subject, then press the shutter button halfway.



3 Keep pressing the shutter button halfway and recompose the picture as desired.

4 Take the picture.

 Focus lock also works in the Basic Zone modes (except). Just start from step 2 above.

When Autofocus Fails

The camera has a high-precision AF system which can focus almost all subjects. However, it can fail to achieve focus (the in-focus indicator <●> blinks) the subjects listed below.

Difficult Subjects for Autofocusing

- Low-contrast subjects. Example: Blue sky, flat surface with a solid color.
- Subjects in very low light.
- Extremely backlit or reflective subjects. Example: Automobile with a highly reflective finish.
- Overlapping near and far objects. Example: Animal behind bars in a cage.

In such cases, use one of the following methods to focus:

- (1) Focus lock an object at the same distance as the subject and recompose.
- (2) Set the lens focus mode switch to <MF> or <M> and focus manually as explained below.

 If focus cannot be achieved even with the EOS-dedicated Speedlite's AF-assist light, select the center focusing point instead of an off-center focusing point.

MF Manual Focusing

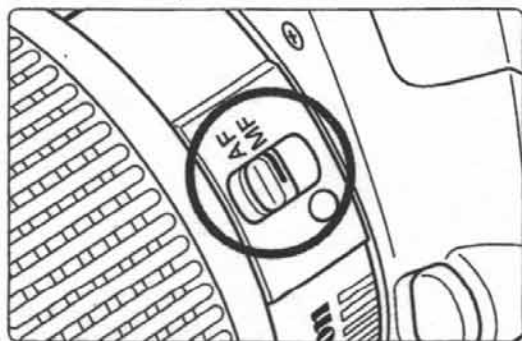

- 1 Set the lens focus mode switch to <MF> (or <M> on older lenses).**
 - The <MF> icon will be displayed on the LCD panel.

- 2 Focus the subject.**
 - Turn the lens manual focusing ring until the subject is in focus in the viewfinder.

 If you focus manually while you hold down the shutter button halfway, the AF frame(s) achieving focus will flash in the viewfinder and the in-focus indicator <●> will also light.

Metering Modes

The camera has three metering modes: Evaluative, partial, and centerweighted averaging metering. Evaluative metering is the standard metering mode. Partial metering is set automatically when AE lock is used (→page 51), and centerweighted averaging metering is set automatically in the <M> mode (→page 48).

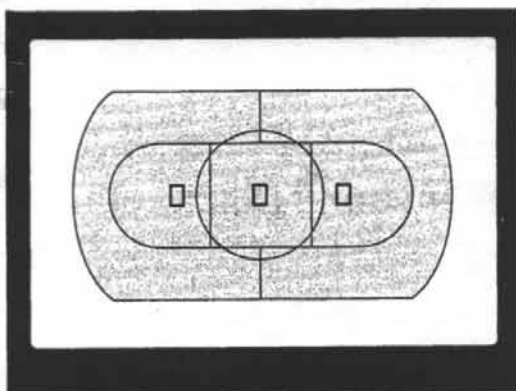

Evaluative metering

This is suited for most shooting situations including backlit conditions. The subject's position and brightness, the background, the existing light, backlight conditions, and the active AF frames are taken into account to obtain a suitable exposure.

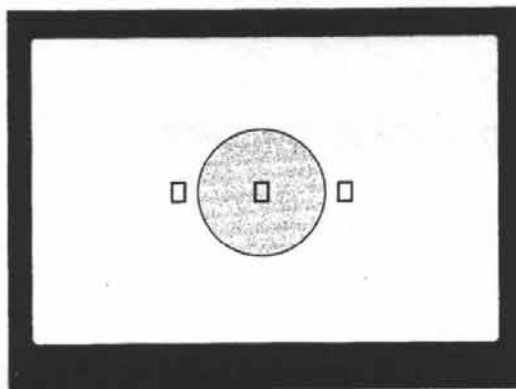

Partial metering

The exposure setting is based on the brightness of an area 9.5% of the viewfinder screen at the center. It is effective for backlit subjects.

- The partial metering area (shaded) is approximated by the diagram on the left.

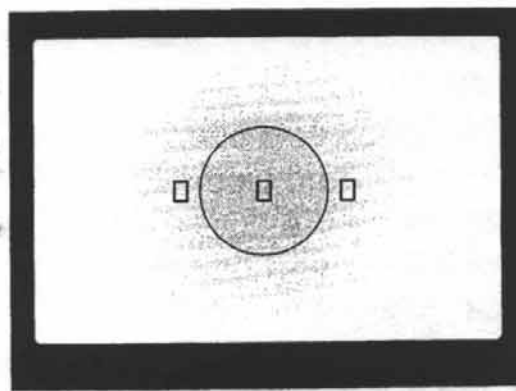

Centerweighted averaging metering

The metering is weighted at the center and then averaged for the entire scene.

 In the One-Shot AF and AI Focus AF (except AI Servo AF) modes (→page 70), when you press the shutter button halfway and focus is achieved, the exposure is locked automatically at the same time.

P Program AE



Like the <□> (Full Auto) mode, this is a general-purpose mode to make picture-taking easy. It sets the shutter speed and aperture automatically to suit the subject's brightness.

* "P" stands for Program.

* "AE" stands for auto exposure.

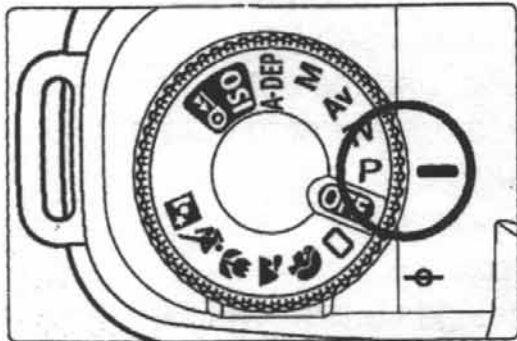

1 Turn the Command Dial to <P>.

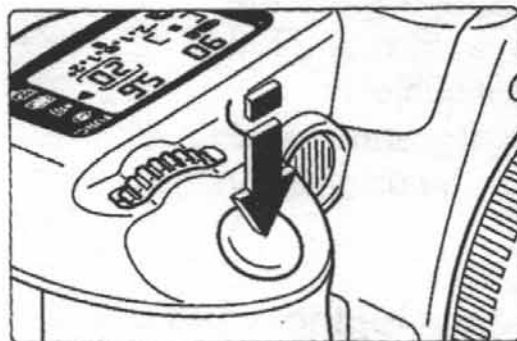

2 Press the shutter button halfway to focus.



3 Check the display.

- ▶ The shutter speed and aperture are set automatically and displayed in the viewfinder and on the LCD panel.
- If the shutter speed and aperture do not blink, a correct exposure will be obtained.
- If the shutter speed and aperture blink, see "Exposure Warning List" on page 69.

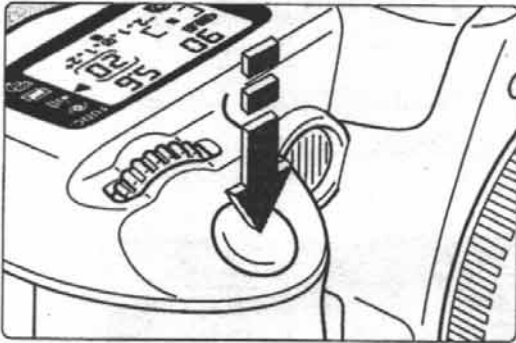

- 4 Take the picture.**
- Compose the shot and press the shutter button completely.

The Difference Between <P> and <□>

- The <P> and <□> modes set the same shutter speed and aperture settings automatically for picture-taking.
- The following features can be used with <P>, but not with <□>:
 - Continuous shooting
 - Manual focusing point selection
 - Program shift
 - AE lock with the <∗> button
 - Exposure compensation
 - AEB
 - Multiple exposures
 - Built-in flash ON/OFF
 - EX-series Speedlite compatibility
 - High-speed sync
 - FE lock

About Program Shift

In the Program AE mode, you can freely change the shutter speed and aperture combination (program) set by the camera while retaining the same exposure. This is called program shift.

To shift the program, press the shutter button halfway and turn the <☀> dial until the desired shutter speed or aperture is displayed.

- After the picture is taken with the shifted program, the shifted program is canceled automatically and the original program is restored.
- Program shift cannot be set when the built-in flash is used.

Tv Shutter-Priority AE

In this mode, you set the shutter speed and the camera sets the aperture automatically to suit the brightness of the scene.

A fast shutter speed can freeze the motion of a fast-moving subject. Or, a slow shutter speed can blur the subject to give the impression of motion.

* "Tv" stands for Time value which is the shutter speed.



Taken with a fast shutter speed.



Taken with a slow shutter speed.

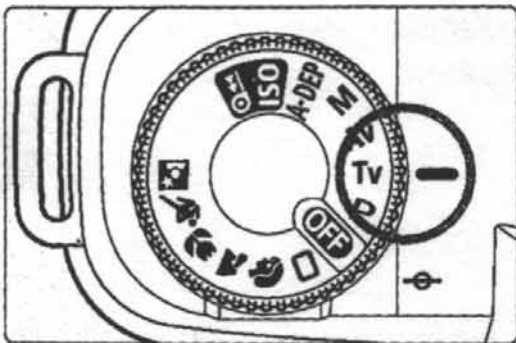

1 Turn the Command Dial to <Tv>.



2 Select the desired shutter speed.
• Look at the LCD panel and turn the <shutter speed icon> dial to set the desired shutter speed.

3 Press the shutter button halfway to focus the subject.
▸ The aperture is set automatically.

Av Aperture-Priority AE

In this mode, you set the aperture and the camera sets the shutter speed automatically to suit the brightness of the subject.

A large aperture (small f-number) will blur the background and make the subject stand out. The larger the aperture, the more blurred the background will look.

Or, a small aperture (large f-number) will increase the depth of field to make both the foreground and background look sharp. The smaller the aperture, the sharper the background will look.

* "Av" stands for aperture value.



Taken with a large aperture.

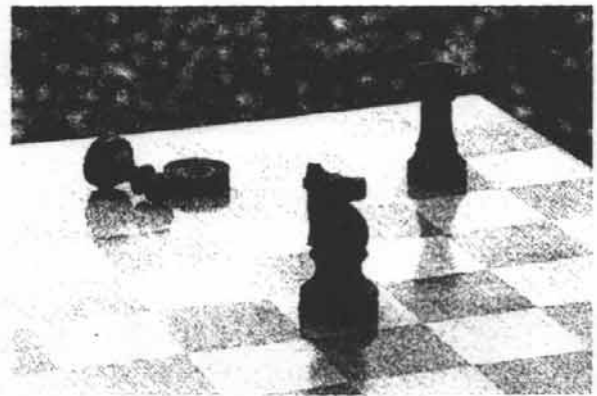

Taken with a small aperture.

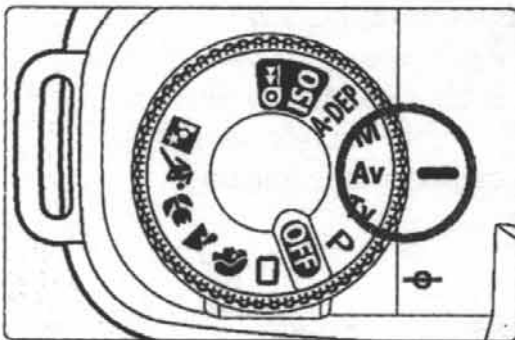

1 Turn the Command Dial to <Av>.

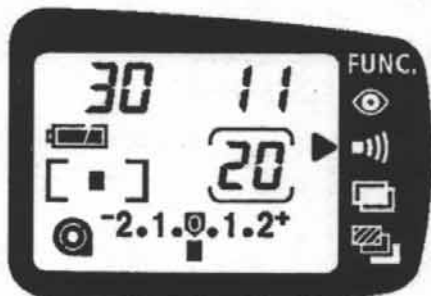

2 Select the desired aperture.
• Look at the LCD panel and turn the <🔍> dial to set the desired aperture.

3 Press the shutter button halfway to focus the subject.

- ▶ The shutter speed is set automatically.

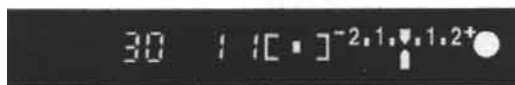

4 Check the viewfinder display and take the picture.

- If the shutter speed display does not blink, a correct exposure will be obtained.



- If the slowest shutter speed blinks, it indicates underexposure. In such a case, turn the <  > dial to set a larger aperture (smaller f-number) until the shutter speed display stops blinking.



- If the maximum shutter speed blinks, it indicates overexposure. In such a case, turn the <  > dial to set a smaller aperture (larger f-number) until the shutter speed display stops blinking.



Aperture Display

The aperture can be set and displayed in full and half stops as shown below. The larger the number, the smaller the aperture opening will be. The displayable range of apertures depends on the lens mounted on the camera.

| | | | | | | | | | | |
|-----|-----|-----|-----|-----|-----|-----|-----|-----|-----|-----|
| 1.0 | 1.2 | 1.4 | 1.8 | 2.0 | 2.5 | 2.8 | 3.5 | 4.0 | 4.5 | 5.6 |
| 6.7 | 8.0 | 9.5 | 11 | 13 | 16 | 19 | 22 | 27 | 32 | |

If no lens is mounted on the camera, "00" will be displayed for the aperture setting.

M Manual Exposure



In this mode, you set both the shutter speed and the aperture for total exposure control. The exposure level of the shutter speed and aperture you set is indicated on the exposure level scale. You can there by check how suitable the exposure will be.

* "M" stands for Manual.

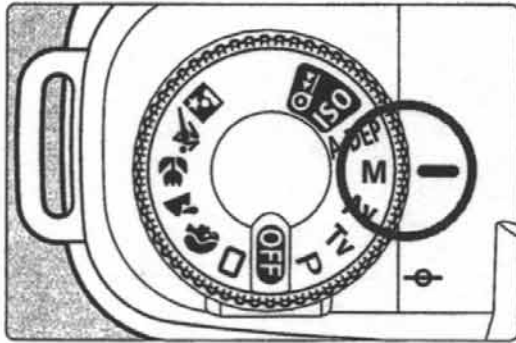

1 Turn the Command Dial to <M>.



2 Select the desired shutter speed with the <☀> dial.

- Turn the <☀> dial until the desired shutter speed is displayed.

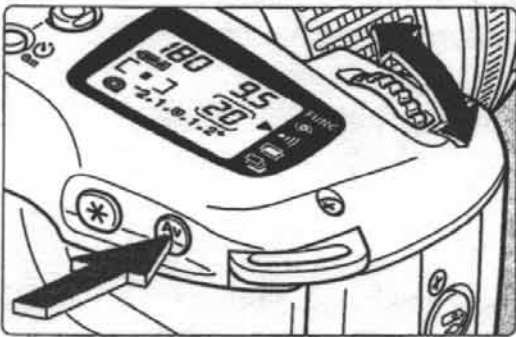

3 Select the desired aperture by holding down the <Av> button and turning the <☀> dial.

- Turn the <☀> dial until the desired aperture is displayed.

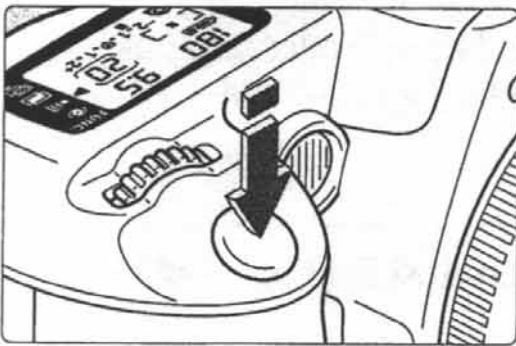

4 Press the shutter button halfway to focus the subject.

- ▶ The exposure level is displayed in the viewfinder.
- The exposure level indicator <■> indicates how close the exposure level is to the correct exposure.



5 Set the exposure setting.

- Look at the exposure level indicator and set the shutter speed and aperture as desired.



- Correct exposure **-2.1.0.1.2+** : This is the standard level for a correct exposure.
- Underexposure **-2.1.0.1.2+** : To achieve the correct exposure, set a slower shutter speed or a larger aperture.
- Overexposure **-2.1.0.1.2+** : To achieve the correct exposure, set a faster shutter speed or a smaller aperture.

- If the exposure level indicator <■> blinks at <2+> or <-2>, it indicates that the exposure is respectively overexposed or underexposed by 2 stops or more.

6 Take the picture.

* AE Lock

With the same AF frame, you can obtain and lock the auto exposure setting on one part of the picture and then recompose to focus a different part of the picture. AE lock enables you to maintain the same exposure setting even after recomposing the shot. This is effective for backlit subjects.



1 Focus the subject where you want to lock the exposure.

- Press the shutter button halfway to focus. (☉4)
- ▶ The exposure setting is displayed in the viewfinder.

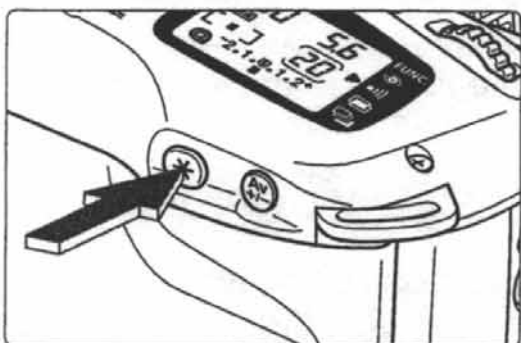

2 Press the <*> button. (☉4).

- Aim the partial metering circle over the part where you want to lock the correct exposure.
- ▶ The <*> indicator lights in the viewfinder and the exposure setting locks (AE lock).
- Each time you press the <*> button, the auto exposure locks over the area covered by the selected AF frame.



3 Compose the shot and take the picture.

- If you want to maintain the AE lock while taking more pictures, hold down the <*> button and press the shutter button to take another picture.

 During AE lock, partial metering (→page 41) is used automatically.

Exposure Compensation

Changing the exposure level set by the camera is called exposure compensation. Exposure compensation can be used to make the picture darker or brighter intentionally. Exposure compensation can be set up to ± 2 stops in half-stop increments.

- 1 Turn the Command Dial to a Creative Zone mode except $\langle M \rangle$.
- 2 Press the shutter button halfway and check the exposure display.

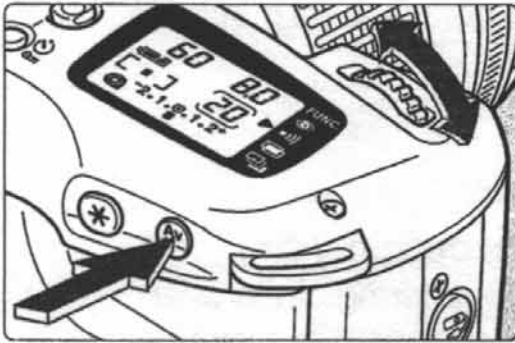

- 3 Press and hold down the $\langle \text{Av} \rangle$ button and turn the $\langle \text{Sun} \rangle$ dial until the desired exposure compensation amount is set. (04)
 - The $\langle + \rangle$ side of the scale indicates increased exposure, and the $\langle - \rangle$ side of the scale indicates decreased exposure.

Increased exposure amount

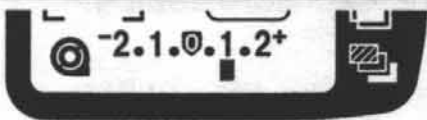

Decreased exposure amount

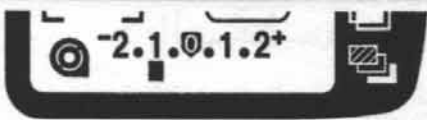

- The exposure compensation amount set is retained even after the Command Dial is set to $\langle \text{OFF} \rangle$.
- To cancel the exposure compensation, set the exposure level indicator back to $\langle 0 \rangle$.

- 4 Take the picture.

- The exposure compensation amount is canceled automatically when you turn the Command Dial to a Basic Zone mode.
- Assuming that a shutter speed of 1/125 sec. and an aperture of f/5.6 will give a correct exposure, setting the exposure compensation amount to plus or minus 1 stop will change the shutter speed or aperture as follows:

| | | | | | |
|---------------|---------|---|-----|---|---------|
| | -1 stop | ← | 0 | → | +1 stop |
| Shutter Speed | 250 | ← | 125 | → | 60 |
| Aperture | 8.0 | ← | 5.6 | → | 4.0 |

Auto Exposure Bracketing (AEB)

With AEB, the camera automatically changes the exposure within the set range (up to ± 2 stops in 1/2-stop increments) for three successive frames. The three bracketed shots are exposed in the following sequence (\rightarrow page 71): Correct exposure, decreased exposure, and increased exposure.

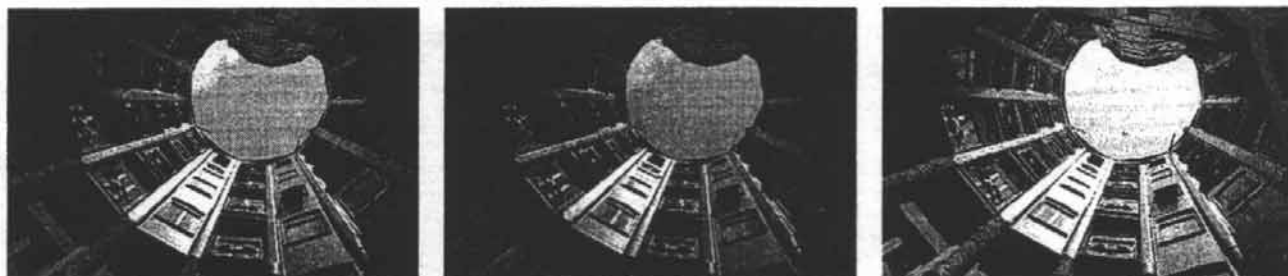

Correct exposure (0)

Decreased exposure (-0.5 stop)

Increased exposure (+0.5 stop)

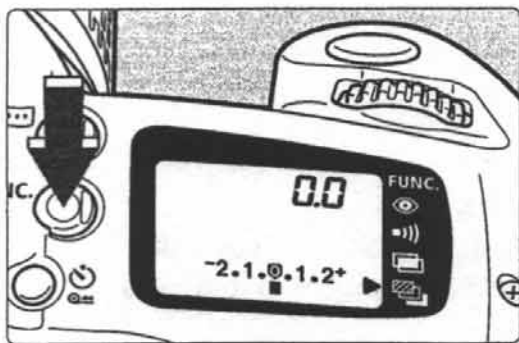

1 Move the $\langle \blacktriangleright \rangle$ arrow to the  icon.

- Look at the LCD panel and press the $\langle \text{FUNC.} \rangle$ button. ($\odot 6$)

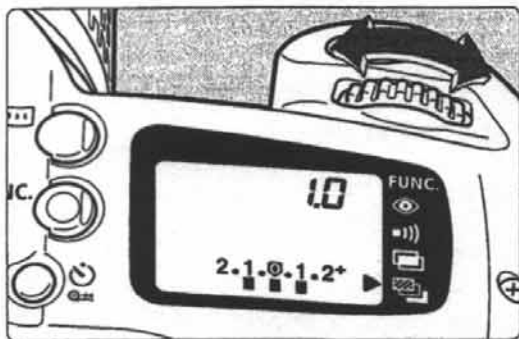

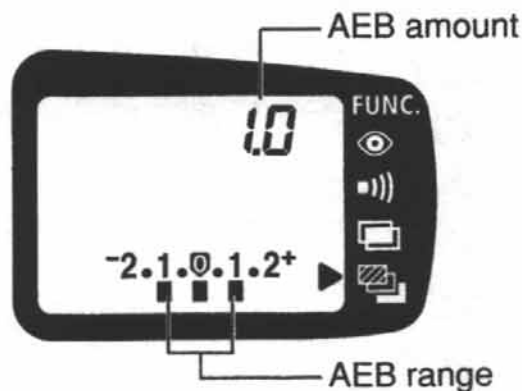

2 Set the desired AEB amount.

- Turn the  dial.
- The AEB amount and AEB range $\langle \blacksquare \rangle$ are displayed on the LCD panel.
- The sample illustration below shows an AEB amount of 1 stop with respect to the correct exposure level.



Auto Exposure Bracketing (AEB)



- 2.1.0.1.2⁺  Correct exposure
- 2.1.0.1.2⁺  Decreased exposure
- 2.1.0.1.2⁺  Increased exposure

3





Take the picture.

- ▶ The respective AEB amount is displayed on the LCD panel and in the viewfinder for each bracketed shot.
- After the three AEB shots are taken, the AEB will not be canceled automatically. To cancel AEB, set the AEB amount back to "00".



 AEB cannot be used with flash or bulb exposures.

-  During AEB shooting, the <▶> icon will blink next to the <> icon.
- In the continuous shooting mode, holding down the shutter button will take all three bracketed shots continuously. However, the viewfinder will not display the respective AEB information.
- If the self-timer or remote control is used, the three AEB shots will be taken in continuous succession automatically.
- AEB can be used in combination with exposure compensation. If the AEB + exposure compensation range you set exceeds the displayable range, it will be displayed as shown below.

In the <P>, <Tv>, <Av>, and <A-DEP> modes:

- 2.1.0.1.2⁺  : ±1 stop AEB.
- 2.1.0.1.2⁺  : ±1 stop AEB with -1-stop exposure compensation.
- 2.1.0.1.2⁺  : ±1 stop AEB with -1.5-stop exposure compensation.
- 2.1.0.1.2⁺  : ±1 stop AEB with -2-stop exposure compensation.

In the <M> mode:

- 2.1.0.1.2⁺  : ±1 stop AEB with -2-stop exposure compensation.
- 2.1.0.1.2⁺  : ±1 stop AEB with over -2-stop exposure compensation.
- 2.1.0.1.2⁺ 

Bulb Exposures

A bulb exposure starts when you press the shutter button completely and ends when you release the shutter button. Bulb exposures are useful when long exposures are required for night scenes, fireworks, astronomical photography, etc.

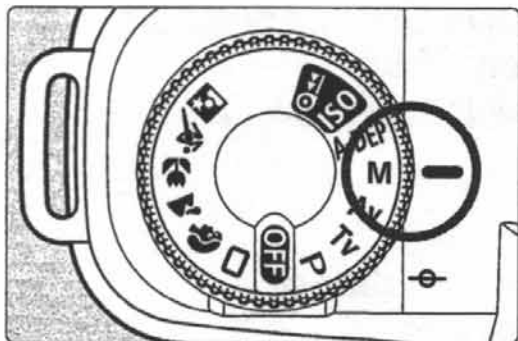

1 Turn the Command Dial to <M>.

2 Set the shutter speed to “bulb”.

- Turn the <shutter speed dial> until “bulb” is displayed on the LCD panel.
- “bulb” follows “30”.

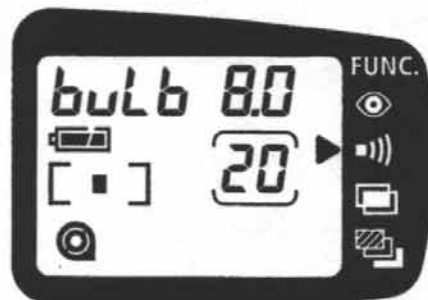

3 Press and hold down the <Av> button and turn the <shutter speed dial> to set the desired aperture.

4 Start the bulb exposure.

- Press and hold down the shutter button.
- During the bulb exposure, “bulb” blinks on the LCD panel.
- The bulb exposure continues as long as you hold down the shutter button.

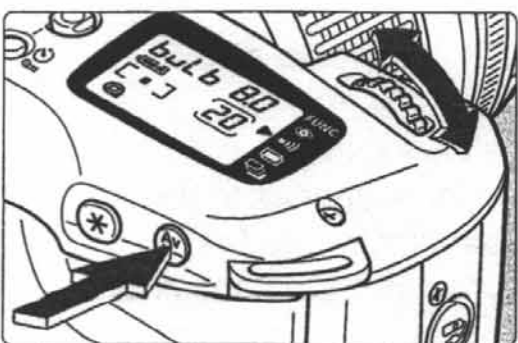

- Remote Switch RS-60E3 (optional) is recommended for bulb exposures.
- With a new set of batteries, the maximum bulb exposure time (at 20°C) will be about 6 hours.

Multiple Exposures

By not advancing the film after taking a picture, a single frame can be shot multiple times. Up to nine multiple exposures can be taken on one frame.

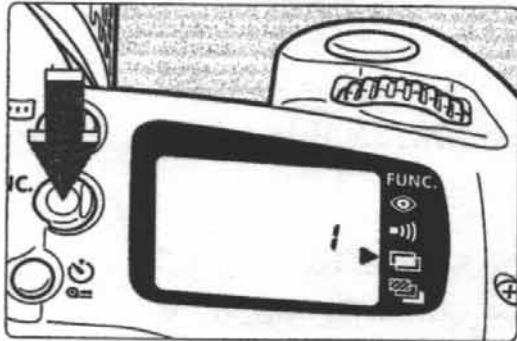

1 Move the <▶> arrow to the <📷> icon.

- Look at the LCD panel and press the <FUNC.> button. (ⓘ6)
- ▶ The frame counter will show "1".

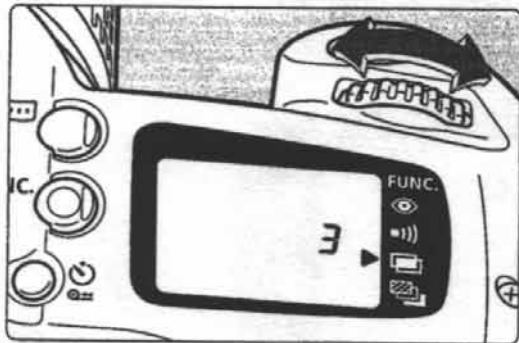

2 Set the desired number of multiple exposures.

- Turn the <🔧> dial.

Three multiple exposures have been set above.

3 Select the shooting mode and take the multiple exposures.

- ▶ After you take all the multiple exposures, the film advances to the next frame automatically and the multiple-exposure setting is canceled.

! If you shoot multiple exposures on the first few or last few frames of roll, the multiple exposures might not be precisely aligned due to the film advance mechanism's characteristics.

- !** • During multiple-exposure shooting, the <▶> arrow next to the <☒> icon on the LCD panel will blink.
- To cancel multiple exposures before shooting, set the number of multiple exposures to 1.
- To cancel multiple exposures after shooting, follow steps **1** and **2** to set the number of multiple exposures to blank.

! Since shooting multiple exposures will expose the same frame multiple times, negative exposure compensation (→page 52) must first be set to avoid overexposure.

General Guide for Exposure Compensation

| | | | |
|------------------------------|-------------|-------------|-------------|
| Multiple Exposures | 2 exposures | 3 exposures | 4 exposures |
| Exposure Compensation Amount | -1.0 stop | -1.5 stop | -2.0 stop |

These are only suggested exposure compensation amounts. The optimum amount depends on the scene. Experiment to find the optimum compensation amount.

Silencing the Beeper

The beeper can be silenced in all of the shooting modes.

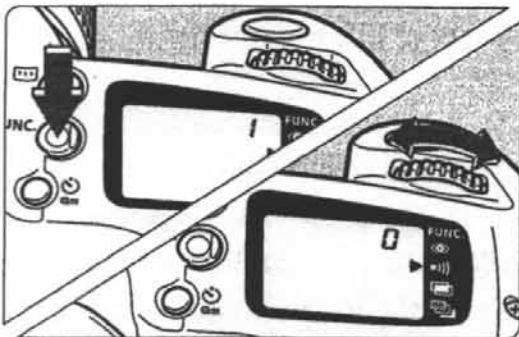

- 1** Move the <▶> arrow to the <☒> icon.
 - Look at the LCD panel and press the <FUNC.> button. (⓪6)
- 2** Set the setting to “0”.
 - Turn the <⚙> dial.
 - To enable the beeper to sound, set to “1”.
 - Press the shutter button halfway to return to normal camera operation.

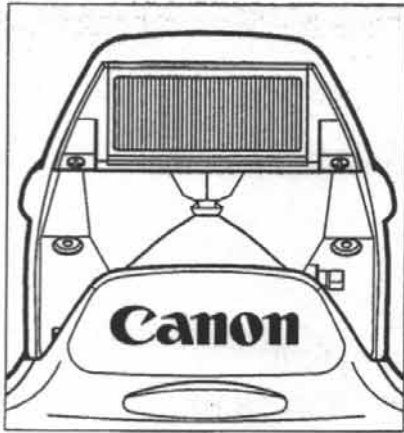

When the built-in flash is popped up, flash photography is easy.

- When using a Basic Zone mode, pop up the flash if the <⚡> icon blinks. If the built-in flash is already popped up, it will fire automatically when necessary in low-light or backlit conditions.
- When using a Creative Zone mode, you can fire the flash at anytime by popping up the built-in flash. You can also set the flash aperture and sync speed (1/90 sec. or slower) and the flash will be controlled automatically to suit the flash aperture you have set.

4

Flash Photography

Using an External EOS-Dedicated Speedlite

Flash photography with an external, EOS-dedicated, EX-series Speedlite is as easy as using the camera's built-in flash. E-TTL autofocus linked to the AF frame is also possible. An external Speedlite is recommended for large group shots requiring a large flash output and for portraits using interesting lighting effects. High-speed sync (FP flash) which can synchronize with all shutter speeds can be used, as well as FE lock (flash exposure lock). For details, read the Speedlite's instructions which apply to Type A cameras.

Using the Built-in Flash

In a Basic Zone Mode

If the <⚡> icon blinks, pop up the built-in flash. The built-in flash will fire automatically in low-light or backlit conditions.

In a Creative Zone Mode

In a Creative Zone mode, you can use the built-in flash at anytime regardless of the existing light level. Just pull up the built-in flash head before taking the picture.

- P** : Use this mode for automatic flash photography. The flash sync speed and flash aperture will be set automatically as with the <□> (Full Auto) mode.
- Tv** : Use this mode if you want to set a flash sync speed slower than 1/90 sec. The camera will set the flash aperture automatically to obtain a correct flash exposure.
- Av** : Use this mode if you want to set the flash aperture. In this mode, you can obtain a balanced exposure between the subject and a dark background (night scene, etc.) with a slow sync speed set automatically by the camera. The flash illuminates the subject while the background is exposed with a long shutter speed.
 - Be sure to use a tripod when a slow sync speed is set.
- M** : This mode enables you to set both the flash sync speed and flash aperture. The subject is properly exposed with the flash and the background is exposed with the flash sync speed and aperture you have set.

A-DEP : The result will be the same as using the <P> mode.



Effective Range of the Built-in Flash (With EF 28-80mm f/3.5-5.6 lens)

| ISO | | 28mm | | 80mm | |
|-----|----|---------------|------------|---------------|------------|
| | | Negative Film | Slide Film | Negative Film | Slide Film |
| 100 | m | 1 - 4.8 | 1 - 3.4 | 1 - 3.0 | 1 - 2.1 |
| | ft | 3.3 - 15.7 | 3.3 - 11.1 | 3.3 - 9.8 | 3.3 - 6.9 |
| 200 | m | 1 - 6.8 | 1 - 4.8 | 1 - 4.3 | 1 - 3.0 |
| | ft | 3.3 - 22.3 | 3.3 - 15.7 | 3.3 - 14.1 | 3.3 - 9.8 |
| 400 | m | 1 - 9.7 | 1.2 - 6.8 | 1 - 6.0 | 1 - 4.3 |
| | ft | 3.3 - 31.8 | 3.9 - 22.3 | 3.3 - 19.7 | 3.3 - 14.1 |

Flash Sync Speeds and Flash Apertures

| Mode | Sync Speed | Flash Aperture |
|-----------|---|--|
| P | The sync speed is set automatically to 1/90 sec. | The flash aperture is set automatically according to the TTL program. |
| Tv | Any sync speed 1/90 sec. or slower can be set manually.* | The flash aperture is set automatically to match the sync speed you set. |
| Av | The sync speed is set automatically within a range of 30" to 1/90 sec. to match the flash aperture you set. | You set the flash aperture manually. |
| M | Any sync speed 1/90 sec. or slower can be set manually.* | |

* If the sync speed is set faster than 1/90 sec., it will be reset automatically to 1/90 sec.

- 
 • When using the built-in flash, stay at least 1 meter away from the subject. Otherwise, part of the photo will look dark.
 - When using the built-in flash, detach any hood attached to the lens. A lens hood will partially obstruct the flash coverage.
 - If any of the following lenses is attached to the camera, the flash coverage of the built-in flash might be obstructed. Use an external, EOS-dedicated Speedlite with these lenses.
 - Fast lenses such as the EF 17-35mm f/2.8L USM and EF 28-70mm f/2.8L USM.
 - Super telephoto lenses such as the EF 300mm f/2.8L IS USM and EF 600mm f/4L IS USM.
 - The built-in flash's flash coverage is effective for lenses with a focal length of 28mm or longer. At focal lengths shorter than 28mm, the periphery of the photograph will look dark.
 - Before attaching an EOS-dedicated Speedlite to the camera, push down the built-in flash if it is popped up.
-
- 
 • To retract the built-in flash, push it down.
 - When it is difficult to focus, the AF-assist beam will be fired automatically. (→page 26)
 - The built-in flash and an external, EOS-dedicated Speedlite attached to the camera cannot be used at the same time.

Flash Photography with a Speedlite EX-Series

With a Canon Speedlite EX-Series, flash photography is easy as using the built-in flash. You can also use the advanced features below.

- This section applies when Speedlite 220EX is attached to the camera.

- **E-TTL Autoflash**

With E-TTL autoflash (preflash evaluative metering), an optimum flash exposure is obtained for the subject in focus. In the aperture-priority AE mode, a slow sync speed is set automatically in low-light conditions to obtain a natural-looking, balanced exposure between the subject and background.



- **High-Speed Sync (FP Flash)**

High-speed sync (FP or focal-plane flash) enables flash synchronization with all of the camera's shutter speeds from 30 sec. to 1/2000 sec.

- **FE (Flash Exposure) Lock**

FE lock obtains and locks the correct flash exposure for any part of the subject. This is the flash equivalent of AE lock.



- E-TTL is an abbreviation for Evaluative-Through-The-Lens.
- With autofocus, the flash exposure is always based on the aperture, and E-TTL autoflash metering is weighted at the active AF frame assumed to be covering the main subject.
- When it is difficult to autofocus, the Speedlite's AF-assist beam is emitted automatically.
- When an external, EOS-dedicated Speedlite except the EX-series is used with the camera, flash photography is as easy as A-TTL/TTL autoflash with the built-in flash.

Full Auto Flash

Full Auto E-TTL autoflash used in the <P> Program AE mode is explained below. For more details on using Speedlite 220EX, see the Speedlite 220EX instruction booklet.

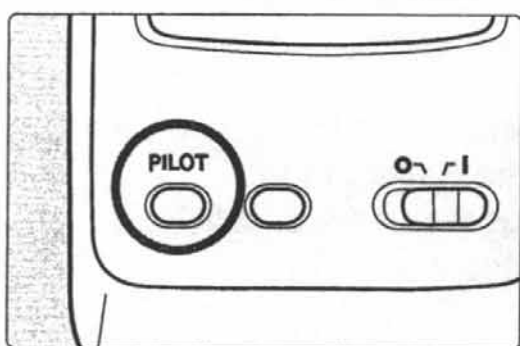

- 1** Turn the Command Dial to <P>.
- 2** Check that the 220EX's pilot lamp is lit.
- 3** Focus the subject.
- 4** Take the picture.
 - Make sure the flash-ready indicator <⚡> is lit, and check the shutter speed and aperture displays before taking the picture.



E-TTL Autoflash in Other Shooting Modes

Even in the <Tv>, <Av>, and <M> modes, E-TTL autoflash is as easy as normal picture-taking without flash.

- (1) When you press the shutter button halfway, the camera sets the shutter speed and aperture.

| Mode | Shutter Speed Setting | Flash Aperture Setting |
|----------------------------------|------------------------------------|------------------------|
| Tv (Shutter-priority AE) | Manual (30 sec. - 1/90 sec.) | Auto |
| Av (Aperture-priority AE) | Auto (30 sec. - 1/90 sec.) | Manual |
| M (Manual exposure) | Manual (Bulb, 30 sec. - 1/90 sec.) | Manual |

- (2) When you press the shutter button completely, preflash evaluative metering based on the aperture set in (1) is used for the E-TTL autoflash exposure.
- (3) The background exposure is set by the shutter speed and aperture combination.



- In the Basic Zone modes, flash photography is as easy as with the built-in flash.
- Using the **<A-DEP>** mode with flash gives the same result as the **<P>** mode.

⚡H High-Speed Sync (FP Flash)

When you press Speedlite 220EX's high-speed sync button **<⚡H>** and turn on the lamp, high-speed sync (FP flash) enables the Speedlite to synchronize at all shutter speeds, even those faster than 1/90 sec. When high-speed sync is enabled, **<⚡H>** is displayed in the viewfinder. High-speed sync is useful in the cases listed below.

- High-speed sync works in Creative Zone modes.

-
- (1) When you want to use fill flash for a portrait and maintain background blur with a large aperture.
 - (2) When you want to create a catchlight in the subject's eyes.
 - (3) When you want to use fill flash to eliminate shadows.



With conventional flash.



With FP flash.

* FE Lock

FE (flash exposure) lock obtains and locks the correct flash exposure reading for any part of the scene.

- FE lock works in Creative Zone modes.

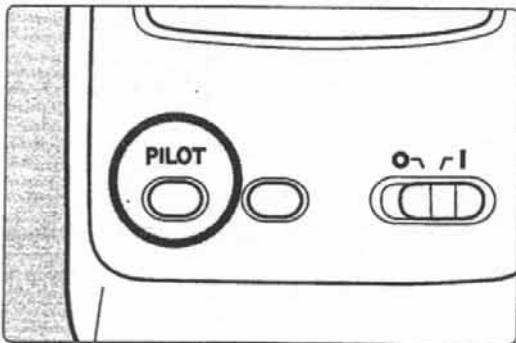

1 Check that the 220EX's pilot lamp is lit.

- The flash mode can be either normal or high-speed sync. FE lock works with either mode.

2 Focus the subject.

- Focus at the point where you want to lock the flash exposure.

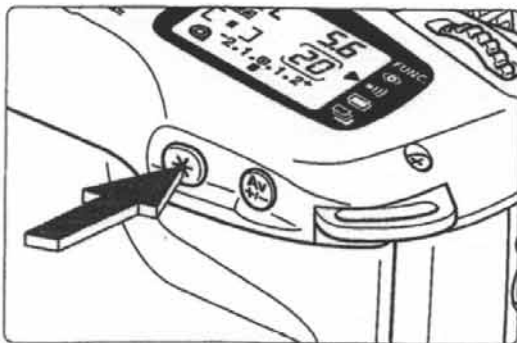

3 Aim the center AF frame where you want to lock the flash exposure, then press the <*> button. (16)

- The <*> icon lights in the viewfinder.
- The Speedlite fires a preflash and stores and locks the flash exposure reading in memory.
- Below the viewfinder, the display shown in ① appears for 0.5 sec. followed by the display shown in ②.
- Each time you press the <*> button, a preflash fires and the flash exposure reading is locked.

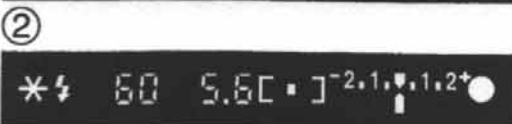



- 4 Take the picture.**
- Compose the shot and take the picture.

ⓘ If the subject is too far away to obtain a correct flash exposure, the <⚡> icon will blink. Get closer to the subject and follow steps **2** and **3** again.

Basic Photography Terms

Exposure

Exposure occurs when the film is exposed to light. Correct exposure is obtained when the film is exposed to a proper amount of light in accordance with the film's sensitivity to light. The correct exposure is adjusted with the camera's shutter speed and aperture.

Shutter speed

The shutter speed is the length of time the camera's shutter opens to expose the film to the light coming through the lens. The shutter speed is displayed on the camera's LCD panel and in the viewfinder. It ranges from 30 sec. to 1/2000 sec. and bulb.

Aperture

The aperture setting (f-number) indicates the size of the aperture opening in the lens. It is used to adjust the amount of light striking the film. The aperture setting is displayed on the camera's LCD panel and in the viewfinder. It can range anywhere from 1.0 to 32, depending on the lens attached to the camera.

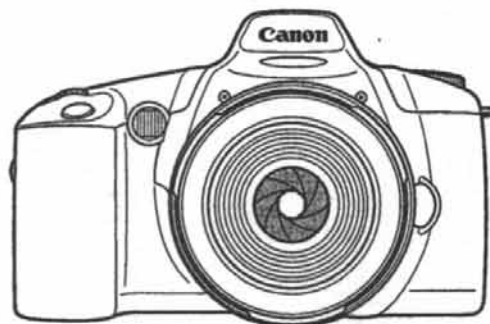

ISO film speed

The ISO film speed indicates the film's sensitivity to light. The higher the film speed, the more sensitive the film is. Therefore, ISO 400 and higher-speed films are suited for low-light conditions. The ISO film speed is set in accordance with standards set by the International Standardization Organization (ISO).

A film speed from 6 to 6400 can be set with the camera. The film speed is displayed on the LCD panel and in the viewfinder.

Depth of field

This is the range where acceptable focus can be achieved in front of and behind the point of optimum focus. The smaller the aperture (the larger the f-number), the deeper the depth of field. And the larger the aperture (the smaller the f-number), the shallower the depth of field.

The depth of field is affected as described below:

- (1) A smaller aperture (a larger f-number) increases the depth of field.
- (2) A longer distance between the camera and subject increases the depth of field.
- (3) When subject distance remains the same, a lens with a shorter focal length increases the depth of field.
- (4) The depth of field behind the point of optimum focus is longer than the depth of field in front of the point of optimum focus.

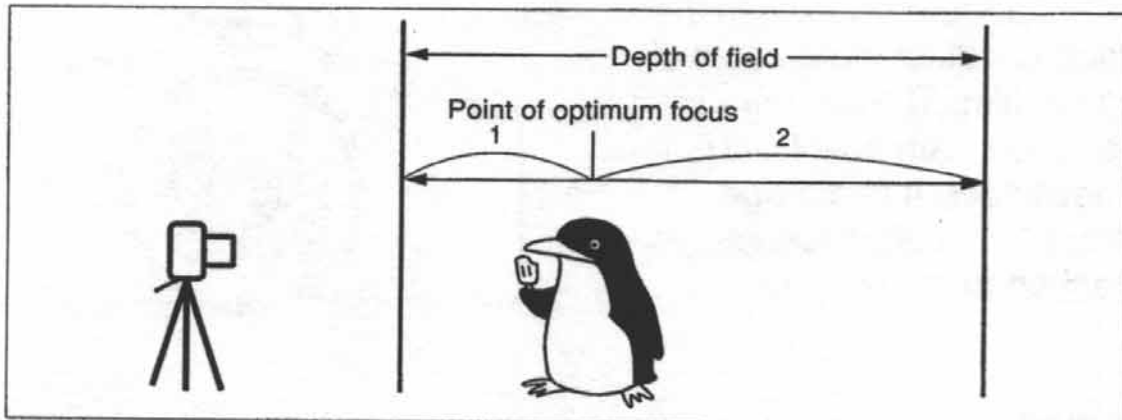

Aperture set to $f/2$.









Aperture set to $f/22$.

Exposure Warning List

| Mode | Blinking Warning | Indication | Countermeasures |
|-------|------------------|--|--|
| P | | The subject is too dark. | Use flash. |
| | | The subject is too bright. | Attach a neutral density filter to the lens. |
| Tv | | The picture will be underexposed. | Turn the dial to set a slower shutter speed. |
| | | The picture will be overexposed. | Turn the dial to set a faster shutter speed. |
| Av | | The picture will be underexposed. | Turn the dial to set a larger aperture (smaller f-number). |
| | | The picture will be overexposed. | Turn the dial to set a smaller aperture (larger f-number). |
| A-DEP | | The desired depth of field cannot be obtained. | 1) Move away from the subject and try again. 2) If a zoom lens is used, use the shortest focal length. |
| | | The subject is too dark. | Use flash. The result will be the same as using the <P> mode. |
| | | The subject is too bright. | Attach a neutral density (ND) filter to the lens. |

 The sample warnings above apply when the lens used has a maximum aperture of f/3.5 and minimum aperture of f/22. The maximum and minimum aperture warning displays will differ depending on the lens attached to the camera.

Feature Availability Table

| Command Dial Mode | AF | | | | | Film Advance | | Metering Mode | | | Standard | Sports |
|---|----------|----------|--------------------|--------|-----------|--------------|------------|---------------|---------|----------------------|----------|--------|
| | One-Shot | AI Focus | AF Frame Selection | | AF-Assist | Single | Continuous | Evaluative | Partial | Center-weighted avg. | | |
| | | | Auto | Manual | | | | | | | | |
| P | | ● | ○ | ○ | ● | | ● | ● | (●) | | ● | |
| Tv | | ● | ○ | ○ | ● | | ● | ● | (●) | | | |
| Av | | ● | ○ | ○ | ● | | ● | ● | (●) | | | |
| A-DEP | ● | | ● | | ● | ● | | ● | (●) | | | |
|  | | ● | ● | | ● | ● | | ● | | | ● | |
|  | ● | | ● | | ● | | ● | ● | | | | |
|  | ● | | ● | | ● | ● | | ● | | | | |
|  | ● | | ● | | ● | ● | | ● | | | | |
|  | | ● | ● | | | | ● | ● | | | | ● |
|  | ● | | ● | | ● | ● | | ● | | | ● | |
| M | | ● | ○ | ○ | ● | | ● | | (●) | ● | | |

● : Set automatically. (●) : Set automatically during AE lock. ○ : User-selectable/settable.

AF Mode

One-Shot AF

The exposure setting (shutter speed and aperture) is set when focus is achieved. The picture cannot be taken unless the subject is focused.

AI Focus AF

The AF mode is set automatically to suit the subject's movement when the shutter button is pressed.

If the subject is still, the focus is locked when focus is achieved (One-Shot AF). If the subject is moving, focusing is continuous and predictive AF is used so that the subject is in focus at the moment of exposure.

| Program AE | | | | Built-in Flash | | Exposure Compensation | AE Lock | FE Lock | Functions | | | | Self-timer |
|------------|----------|-----------|---------|----------------|---------------|-----------------------|---------|---------|-------------------|--------|--------------------|-----|------------|
| Portrait | Close-up | Landscape | P Shift | Auto Firing | Manual Firing | | | | Red-eye Reduction | Beeper | Multiple Exposures | AEB | |
| | | | ○ | | ○ | ○ | ○ | ○ | ○ | ○ | ○ | ○ | ○ |
| | | | | | ○ | ○ | ○ | ○ | ○ | ○ | ○ | ○ | ○ |
| | | | | | ○ | ○ | ○ | ○ | ○ | ○ | ○ | ○ | ○ |
| | | | | | ○ | ○ | ○ | ○ | ○ | ○ | ○ | ○ | ○ |
| | | | | ● | | | | | ○ | ○ | | | ○ |
| ● | | | | ● | | | | | ○ | ○ | | | ○ |
| | | ● | | | | | | | | ○ | | | ○ |
| | ● | | | ● | | | | | ○ | ○ | | | ○ |
| | | | | | | | | | | ○ | | | ○ |
| | | | | ● | | | | | ○ | ○ | | | ○ |
| | | | | | ○ | | ○ | ○ | ○ | ○ | ○ | ○ | ○ |

AF Mode and Film Advance Mode

| Film Advance Mode | One-Shot AF | AI Servo AF |
|-------------------|---|--|
| Single | The picture cannot be taken until focus is achieved. When focus is achieved, it also locks at the same time. The evaluative metering's exposure reading is also locked. (The exposure setting is retained before the picture is taken.) | Autofocusing continues to match the subject's movement. The exposure setting is determined at the moment of exposure. |
| Continuous | The same conditions as above apply during continuous shooting (at about 1 frame per second). | The same conditions above apply during continuous shooting. Autofocusing continues during continuous shooting (at about 1 frame per second). |

Troubleshooting Guide

If there is a problem, try to resolve it by referring to this Troubleshooting Guide. If the problem still persists, take the camera to your nearest Canon Service Center.

| | |
|--|---|
| <p>Nothing is displayed on the LCD panel.</p> | <p>The batteries are exhausted.</p> <ul style="list-style-type: none"> ▶ Replace the batteries with new ones. (→page 16) <p>The batteries have been installed incorrectly.</p> <ul style="list-style-type: none"> ▶ Install the batteries correctly. (→page 16) |
| <p>The picture looks blurred.</p> | <p>The lens focus mode is set to <MF> (or <M>).</p> <ul style="list-style-type: none"> ▶ Set the lens focus mode to <AF>. (→page 18) <p>There was camera shake when the picture was taken.</p> <ul style="list-style-type: none"> ▶ Hold the camera steady or use a faster shutter speed. (→page 19) |
| <p>The shutter does not work.</p> | <p>The frame count is not displayed on the LCD panel.</p> <ul style="list-style-type: none"> ▶ Take out the film and load it correctly. (→page 20) <p>The <□> icon blinks on the LCD panel.</p> <ul style="list-style-type: none"> ▶ Replace the batteries with new ones. (→page 16) <p>The <⊙> icon blinks while the rewind film is still in the camera.</p> <ul style="list-style-type: none"> ▶ Replace with a new roll of film. (→page 20) <p>The in-focus indicator <●> in the viewfinder blinks and focus cannot be achieved.</p> <ul style="list-style-type: none"> ▶ Select another AF frame. (→page 38) ▶ If focus still cannot be achieved, focus manually. (→page 40) |
| <p>The <□> icon blinks on the LCD panel.</p> | <p>The battery level is very low.</p> <ul style="list-style-type: none"> ▶ Replace the batteries with new ones. (→page 16) <p>A misoperation has occurred.</p> <ul style="list-style-type: none"> ▶ Press the shutter button halfway. (→page 19) ▶ Remove and reload the batteries. (→page 16) <p>If the <□> icon stops blinking, picture-taking is possible. If it is still blinking, consult your nearest Canon Service Center.</p> |

Major Accessories



- **Battery Pack BP-8**

An external battery pack housing widely-available size-AA batteries which can power the camera in place of CR123 (or DL123A) lithium batteries. Handy when lithium batteries are not available.

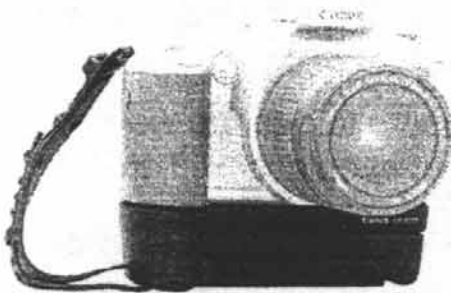

- **Grip GR-80TP**

Grip GR-80TP enlarges the camera grip to enhance holding ease. It can also unfold as a mini-tripod for self-timer or low-angle shots.



- **Speedlites EX-series**

EOS-dedicated, E-TTL autoflash Speedlites that attach to the camera's hot shoe.



- **Remote Switch RS-60E3**

Dedicated cable release for a tripod-mounted camera. Ideal for close-up shots and bulb exposures. Connects to the camera's remote control jack.



- **Eyepiece Extender EP-EX15**

When attached to the camera, this eyepiece extender extends the EOS camera's eye relief by 15 mm. The viewfinder magnification also becomes 0.5x.



- **Dioptric Adjustment Lens E**

The camera's eyepiece lens is -1 diopter. Attaching a Dioptric Adjustment Lens E on the eyepiece allows near- or far-sighted users to see the viewfinder clearly without eyeglasses. Ten eyesight correction lenses are available. When choosing an eyesight correction lens, attach it to the eyepiece and look through the viewfinder to see if it suits your vision.

- The number on the dioptric correction lenses indicates the diopter when it is attached to the camera's eyepiece. It is not the diopter of the eyesight correction lens itself.



- **Camera Case EH8N-L and EH8N-LL**

Dedicated case which can accommodate the camera attached with a lens.

- When using an external flash unit, an EOS-dedicated Speedlite is recommended. Using a flash unit (equipped with electrical contacts on the hot shoe foot), high-voltage flash unit, or flash accessories dedicated to a different brand may result in camera misoperation or malfunction.

Major Specifications

• Type

| | |
|-------------------------|---|
| Type | 35mm AF/AE SLR camera with focal-plane shutter, built-in winder and flash |
| Recording media | 35mm film |
| Image size | 24 x 36mm |
| Compatible lenses | Canon EF lenses (excepting EF-S lenses) |
| Lens mount | Canon EF mount (electronic data exchange) |

• Viewfinder

| | |
|------------------------------|---|
| Type | Eye-level pentamirror |
| Coverage | 90% vertically and horizontally |
| Magnification | 0.7x (-1 diopter with 50mm lens at infinity) |
| Eyepoint | 18.5mm |
| Standard diopter | -1 diopter |
| Focusing screen | Fixed (New Laser Matte screen) |
| Mirror | Quick-return half mirror |
| Viewfinder information | AF (AF frame, in-focus mark); Exposure (shutter speed, aperture, manual exposure, metering range, exposure level, exposure warning); Flash (flash ready, hi-speed sync, FE lock, red-eye reduction) |

• Autofocus

| | |
|---------------------------------|--|
| Type | TTL-SIR with multiple BASIS |
| Focusing points | 3 focusing points |
| AF working range | EV 2 - 18 (ISO 100) |
| Focusing modes | One-Shot AF/AI Focus AF/Manual focusing |
| AF frame selection | Automatic/manual |
| Selected AF frame display | AF frame marks in viewfinder and also indicated on LCD panel. |
| AF-assist beam | Lamp Working distance: Approx. 4m (13.1ft) at center, Approx. 2.5m (8.2ft) at periphery |

• Exposure Control

| | |
|-------------------------------|---|
| Exposure metering modes | TTL full aperture metering with 6-zone SPC. <ol style="list-style-type: none">1. Evaluative metering (linkable to any AF frame)2. Partial metering (Automatically set with AE lock, approx. 9.5% of viewfinder at the center.)3. Center-weighted averaging metering (automatically set in manual exposure mode) |
|-------------------------------|---|

Reference

| | |
|--------------------------|--|
| Metering range | EV 2 - 20 (normal temperature, 50mm f/1.4, ISO 100) |
| Exposure control | Program AE (shiftable), shutter-priority AE, aperture-priority AE, automatic depth-of-field AE, full auto, five programmed image control modes (portrait, landscape, close-up, sports, night scene portrait), E-TTL/A-TTL/TTL program autoflash, manual exposure |
| Film speeds | ISO 6 - 6400 (Set automatically for DX-coded film within ISO 25 - 5000 in 1/3-stop increments.) |
| Exposure compensation... | Manual exposure compensation: +/- 2 stops in 1/2-stop increments (can be used with AEB). Auto Exposure Bracketing (AEB): +/- 2 stops in 1/2-stop increments. |
| AE lock | Auto AE lock: Operates in One-shot AF mode with evaluative metering when focus is achieved. Manual AE lock: By AE lock button in partial metering mode. |
| Multiple exposures | Max. 9 exposures |

• Shutter

| | |
|-----------------------|--|
| Type | Electronically controlled focal-plane shutter |
| Shutter speeds | 1/2000 - 30sec. in 1/2-stop increments, X sync at 1/90sec. |
| Shutter release | Soft touch electromagnetic release |
| Self-timer | Shoot after 10sec. delay |

• Flash

| | |
|---------------------------------|--|
| Built-in flash..... | AF frame-linked, 3-zone autoflash Guide No. 12 (ISO 100, meters), 39 (ISO 100, feet) Recycling time: Approx. 2sec. Flash coverage: 28mm lens angle covered Red-eye reduction: Lamp |
| External EOS-dedicated flash... | E-TTL/A-TTL/TTL autoflash |

• Film Transport

| | |
|-------------------------------|----------------------------------|
| Film loading | Automatic prewind |
| Film advance modes | Single-frame/continuous shooting |
| Continuous shooting speeds... | Approx. 1fps. |
| Frame counter | Counts down |
| Film rewind | Automatic. Mid-roll rewind |
| Rewind noise..... | Approx. 56dB |

• Date Imprinting

Automatic dating.....Automatic calendar to 2019
 Power sourceOne CR2025 lithium battery

• Other Specification

Power sourceTwo CR123A (or DL123A) lithium batteries
 Battery life 24-ex. film (Approx. rolls)

| Conditions | Normal temperature (20 degree C) | Low temperature (-10 degree C) |
|----------------|-------------------------------------|-----------------------------------|
| No flash use | 85 | 60 |
| 50% flash use | 35 | 25 |
| 100% flash use | 17 | 12 |

Battery check.....Automatic
 Dimensions (W x H x D)..145.0 x 92.0 x 61.9mm / 5.71 x 3.62 x 2.43in
 WeightNormal : 350g/12.35oz
 (body only, excluding battery) QD : 365g/12.87oz

- All the specifications above are based on Canon’s testing and measuring standards.
- Specifications and physical appearance are subject to change without notice.

This device complies with Part 15 of the FCC Rules. Operation is subject to the following two conditions: (1) This device may not cause harmful interference, and (2) this device must accept any interference received, including interference that may cause undesired operation.

Do not make any changes or modifications to the equipment unless otherwise specified in the instructions. If such changes or modifications should be made, you could be required to stop operation of the equipment.

This equipment has been tested and found to comply with the limits for a class B digital device, pursuant to part 15 of the FCC Rules. These limits are designed to provide reasonable protection against harmful interference in a residential installation. This equipment generates, uses and can radiate radio frequency energy and, if not installed and used in accordance with the instructions, may cause harmful interference to radio communications. However, there is no guarantee that interference will not occur in a particular installation. If this equipment does cause harmful interference to radio or television reception, which can be determined by turning the equipment off and on, the user is encouraged to try to correct the interference by one or more of the following measures:

- Reorient or relocate the receiving antenna.
- Increase the separation between the equipment and receiver.
- Consult the dealer or an experienced radio/TV technician for help.

This digital apparatus does not exceed the Class B limits for radio noise emissions from digital apparatus as set out in the interference-causing equipment standard entitled "Digital Apparatus", ICES-003 of the Industry Canada.

CE The CE Mark is a Directive conformity mark of the European Community (EC)



| | |
|---|----|
| A | |
| Accessories | 73 |
| <  > AEB | 53 |
| < * > AE lock | 51 |
| AF | |
| - frame selection | 38 |
| - when AF fails | 40 |
| automatic AF frame selection | 38 |
| manual AF frame selection | 38 |
| AF modes | |
| - and film advance modes | 71 |
| AI Focus AF | 70 |
| AI Servo AF | 71 |
| aperture | 67 |
| < Av > Aperture-priority AE | 46 |
| < A-DEP > Automatic Depth-of-field AE | 50 |
| automatic AF frame selection | 38 |



| | |
|--|----|
| B | |
| Basic Zone | 14 |
| batteries | |
| - installing | 16 |
| - level check | 17 |
| replacing the quartz date back's battery | 36 |
| built-in flash | 26 |
| - effective range | 60 |
| - firing AF-assist beam | 26 |
| - using | 60 |
| bulb exposure | 55 |











| | |
|---|--------|
| C | |
| Centerweighted averaging metering | 41 |
| <  > Close-up mode | 30 |
| Command Dial | 14 |
| continuous shooting | 26, 71 |
| conventions used in this instruction booklet | 3 |
| Creative Zone | 14 |

| | |
|---------------|--|
| D | |
| date and time | |
| 78 | |

| | |
|----------------------|----|
| - imprinting | 35 |
| - setting | 36 |
| depth of field | 68 |

| | |
|--|----|
| E | |
| E-TTL autoflash | 62 |
| Evaluative metering | 41 |
| exposure | 67 |
| - warnings | 69 |
| < * > AE lock | 51 |
| <  > auto exposure bracketing | 53 |
| < M > manual exposure | 48 |
| <  > multiple exposures | 56 |
| exposure compensation | 52 |
| eyecup | 34 |
| eyepiece cover | 34 |

| | |
|--|----|
| F | |
| Feature Availability Table | 70 |
| < * > FE lock | 65 |
| film | |
| - ISO film speed | 67 |
| - loading | 20 |
| - <  > Midroll rewind | 21 |
| - < ISO > setting the ISO film speed | 58 |
| - unloading | 21 |
| battery life | 17 |
| flash | |
| - sync speeds and apertures | 61 |
| - using flash | 60 |
| flash and Full Auto mode | 63 |
| flash and other shooting modes | 63 |
| focusing | |
| < A-DEP > Automatic Depth-of-field AE | 50 |
| <  > Manual focusing | 40 |
| off-center subjects | 39 |
| FP flash | 64 |
| <  > Full Auto mode | 24 |

- H**
- <  > High-speed sync (FP flash)64
 - Holding the Camera.....22
- I**
- < ISO > setting the ISO film speed.....58
- L**
- <  > Landscape mode29
 - LCD panel.....12
 - lens
 - detaching18
 - mounting.....18
- M**
- < M > Manual exposure.....48
 - <  > Manual focusing.....40
 - manual AF frame selection38
 - metering modes
 - Centerweighted averaging.....41
 - Evaluative41
 - Partial.....41
 - <  > Multiple exposures.....56
- N**
- <  > Night ScenePortrait mode32
 - Nomenclature10
- O**
- One-Shot AF.....70
- P**
- Partial metering.....41
 - <  > Portrait mode.....28
 - < P > Program AE.....42
 - < P > and <  > (Full Auto) differences.....43
 - program shift.....43
 - Programmed Image Control Zone14
- R**
- <  > Red-eye reduction27
 - Remote Switch.....58
- S**
- <  > Self-timer33
 - shutter button.....19
 - complete pressing19
 - halfway pressing.....19
 - shutter speed67
 - < Tv > Shutter-priority AE44
 - <  > silencing the beeper57
 - single-frame shooting26, 71
 - specifications75
 - <  > Sports mode31
 - strap, attaching15
- T**
- < Tv > Shutter-priority AE44
- V**
- viewfinder information.....13

Canon

CANON INC. 30-2, Shimomaruko 3-chome, Ohta-ku, Tokyo 146-8501, Japan

U.S.A. ——— CANON U.S.A. INC.

For all inquiries concerning this camera, call toll free in the U.S.
1-800-OK-CANON or write to: Customer Relations, Canon U.S.A., Inc.
One Canon Plaza, Lake Success, N.Y. 11042-1198

CANADA ——— CANON CANADA INC. HEADQUARTERS

6390 Dixie Road, Mississauga, Ontario L5T 1P7, Canada
CANON CANADA INC. MONTREAL BRANCH
5990, Côte-de-Liesse, Montréal Québec H4T 1V7, Canada
CANON CANADA INC. CALGARY OFFICE
2828, 16th Street, N.E. Calgary, Alberta T2E 7K7, Canada
For all inquiries concerning this camera, call toll free in Canada
1-800-OK-CANON

EUROPE, ——— CANON EUROPA N.V.

AFRICA & Bovenkerkerweg 59-61, P.O. Box 2262, 1160 EG Amstelveen, The Netherlands

MIDDLE EAST

CANON COMMUNICATION & IMAGE FRANCE S.A.
102, Avenue du Général de Gaulle 92257 La Garenne-Colombes Cedex, France

CANON UK LTD.

Woodhatch Reigate Surrey RH2 8BF, United Kingdom

CANON DEUTSCHLAND GmbH

Europark Fichtenhain A10, 47807 Krefeld, Germany

CANON ITALIA S.p.A.

Via Milano 8 I-20097 San Donato Milanese, Milano, Italy

CANON Schweiz AG

Geschäftsbereich Wiederverkauf, Industriestrasse 12, CH-8305 Dietlikon, Switzerland

CANON G. m. b. H.

Oberlaaerstrasse 233, 4th floor, 1100 Wien, Austria

CANON España, S. A.

C/Joaquín Costa, 41, 28002 Madrid, Spain

SEQUE Soc. Nac. de Equip., Lda.,

Praça da Alegria, 58, 2º, 1269-149 Lisboa, Portugal

CENTRAL & ——— CANON LATIN AMERICA, INC. DEPTO DE VENTAS

SOUTH AMERICA 703 Waterford Way Suite 400 Miami, FL 33126 U.S.A.

CANON LATIN AMERICA, INC. CENTRO DE SERVICIO Y REPARACION

Apartado 2019, Zona Libre de Colón, República de Panamá

ASIA ——— CANON HONGKONG CO., LTD.

9/F, The Hong Kong Club Building, 3A Chater Road, Central, Hong Kong

CANON SINGAPORE PTE. LTD.

79 Anson Road #09-01/06 Singapore 079906

OCEANIA ——— CANON AUSTRALIA PTY. LTD.

1 Thomas Holt Drive, North Ryde, N.S.W. 2113, Australia

CANON NEW ZEALAND LTD.

Akoranga Business Park, Akoranga Drive, Northcote Auckland, New Zealand

JAPAN ——— CANON SALES CO., INC.

16-6, Kohnan 2-Chome, Minato-ku, Tokyo 108-8011, Japan

This Instructions booklet is current as of September 2001. For information on using the camera with system accessories introduced after this date, contact your nearest Canon Service Center.