

A black and white photograph of a herd of horses running through a field of tall grass. The horses are in various stages of a gallop, with their manes and tails flowing. The background is a soft-focus field of grass, creating a sense of motion and natural beauty.

Canon EOS 1

E

INSTRUCTIONS
English Edition

Table of Contents

Nomenclature	3 & 78
Introduction	4
Precautions	6

PREPARATIONS

A. Battery Load and Check	8
B. Main Switch	11
C. Lens Attachment	12
D. Dioptic Adjustment	14
E. Focusing	15
F. Display Panel Information	17
G. Film Load	18
Film Speed Setting	20
H. Film Rewind	21
I. Film Winding Mode	22
Self-Timer	24
J. Setting the AF Mode	26
K. Setting the Metering Mode	28
AE Lock Photography	30

ESSENTIAL OPERATIONS

L. Setting the Shooting Mode	33
------------------------------------	----

M. Difficult Subjects for Autofocus	43
N. Exposure Compensation	46
O. Auto Exposure Bracketing	49
P. Multiple Exposure	51
Q. Custom Function Control	54
Special Film Usage	
Shooting with Infrared Film	57
R. Dedicated Flash Photography	58

OTHER INFORMATION

S. Reference	62
T. Camera Care	64
U. Accessories	65
V. Appendix	69
Viewfinder Information	69
Display Panel Information	70
Program Line Characteristics	71
Battery Shooting Capacity	73
Comparisons between AF Mode and	
Film Winding Mode	74
W. Specifications	75

2

Nomenclature

See p. 78 for back view

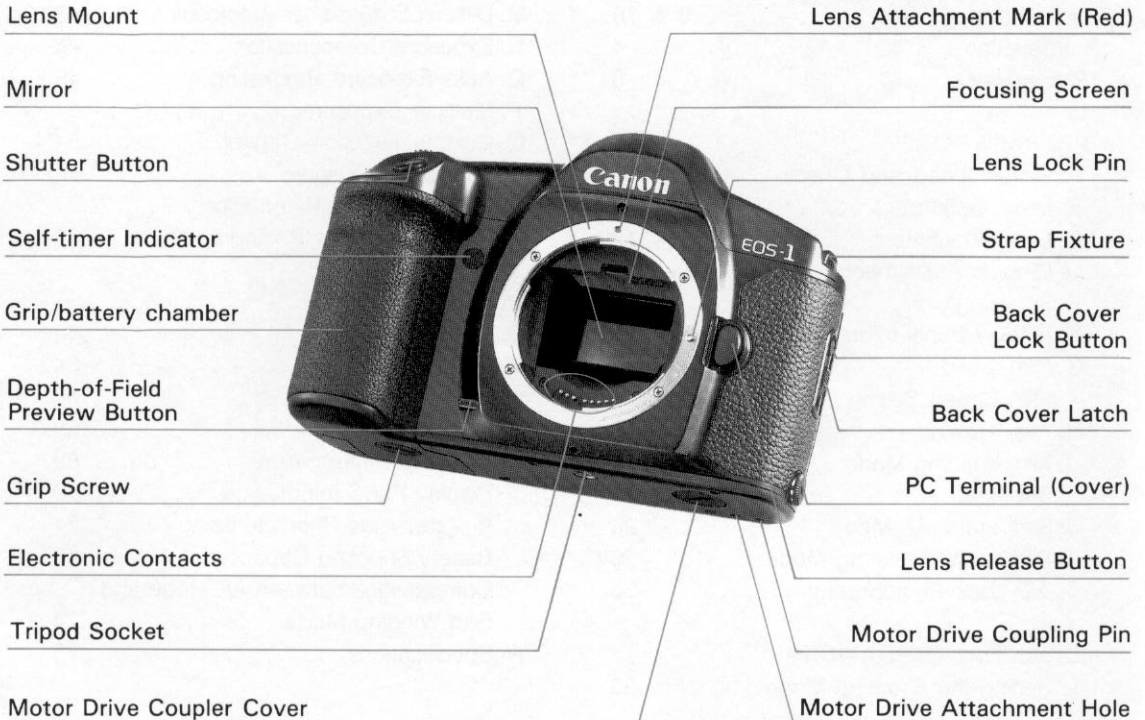

Introduction

Thank you for selecting a Canon autofocus SLR camera.

With the distinction of being Canon's top of the line AF SLR, the EOS-1 represents the sum total of considerable efforts to design a camera that meets the requirements of the most demanding professional photographers. These people know exactly what their needs are and will appreciate the detail and design considerations that have been incorporated in the EOS-1.

There are three main points in the design of the EOS-1 to which particular attention has been paid:

1. To allow the photographer complete concentration on picture composition.
2. To support photographer's freedom of choice by allowing complete control of basic camera operations.
3. To provide the necessary performance for today's expanded shooting opportunities.

Using new technology, the EOS-1 has the fastest, most responsive AF in the EOS series, a more comprehensive metering system, Predictive Focusing for moving subjects, and enhanced reliability to handle difficult shooting conditions. Custom Function Control gives you the freedom to set certain functions to your preference.

There is a full line of EF lenses, Speedlites, and important accessories such as the Power Drive Booster E1 and Command Back E1 which meet the requirements for a variety of shooting tasks.

4

Attention

For a thorough understanding of the EOS-1, please read this instruction book carefully.

While reading these instructions, unfold the front and back flaps for easy reference to the camera's parts.



- The camera is shown with a 28-70 mm lens attached.
- Before loading the first roll of film, remove the plastic sheet on the inside of the back cover.

IMPORTANT INFORMATION

The Canon EOS-1 will give optimum performance together with specially designed Canon EOS EF lenses and other Canon brand accessories. It is possible that the use of incompatible lenses or other accessories may result in unsatisfactory performance or damage to your Canon EOS-1. We therefore suggest the use of Canon EOS lenses and accessories. Damage to your Canon EOS-1 as a result of malfunction or improper connections caused by the use of incompatible products may void its warranty.

5

Precautions

- 1) The Canon EOS-1 has been designed for increased resistance to moisture. However, this camera is **not waterproof** and must therefore be handled with reasonable care. Keep the camera out of salt spray and protect it from excessive moisture. If used at the beach, clean it thoroughly afterward with a dry cloth. If dropped in water, contact an authorized Canon service facility.
- 2) Do not attempt to disassemble the camera yourself. Always take it to an authorized Canon service facility for repair.
- 3) Remove the battery if you do not expect to use the camera for about three weeks or longer.
- 4) When storing the camera, wrap it in a clean, soft cloth and place in a cool, dry, dust-free place. Be sure to keep the camera out of direct sunlight, and away from "hot spots" such as the trunk or rear window shelf of a car. Avoid places where moth balls are used and in excessive humidity, use a desiccant.
- 5) Carefully check the camera's operation after prolonged storage.
- 6) The battery may explode or cause burns if disassembled, recharged, shorted, exposed to high temperatures, or disposed in fire.
- 7) Film passing through X-ray examinations at airports may be exposed and ruined even when loaded in the camera. Request a hand-checked inspection to avoid damage.
- 8) Aerosol spray dust removers are not recommended for the shutter curtain.
- 9) Condensation is a problem when bringing cold equipment into a warm room. If the autofocus optics cloud over, accuracy may be seriously affected. Before entering a warm room, put equipment in a plastic bag so condensation forms on the outside of the bag.

PREPARATIONS



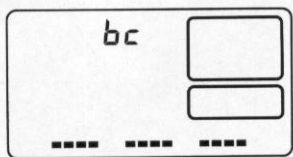

•Three bars— Battery power sufficient

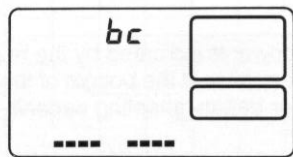

•Two bars— Have a spare handy

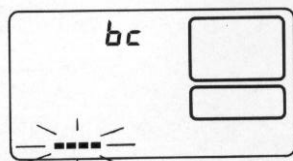

•One bar (blinking)— Replace battery

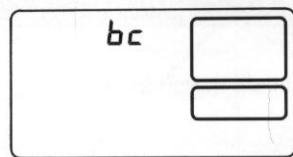

•bc (no bar)— Replace battery

•Blinking bc — Replace battery if old; reload if new. See p. 63.

B. Main Switch

The main switch has three positions:

L — Off position. Be sure to set here after shooting to prevent accidental shutter release and minimize battery drain.

A — Standard operating position. No audible signals sound.

||| — Same as A, but with audible in-focus signal.

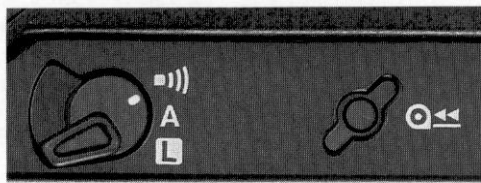
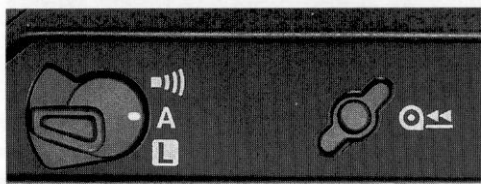
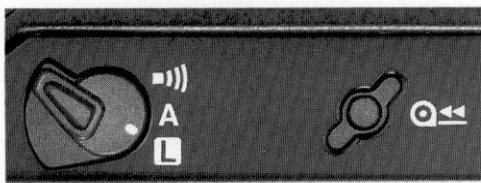

A. Battery Load and Check

The camera operates on a 6-volt, 2CR5 lithium battery.

- 1) Remove the grip by turning its screw on the bottom of the camera with a coin or viewfinder cover. This screw cannot be removed from the grip.
 - 2) Load the battery upside down with the label facing you.
 - 3) Replace the grip securely.
- When the Power Drive Booster E1 is attached, the 2CR5 is replaced by the Booster's battery magazine. See the Booster's instructions for details.
 - See p. 62 for other important battery information.

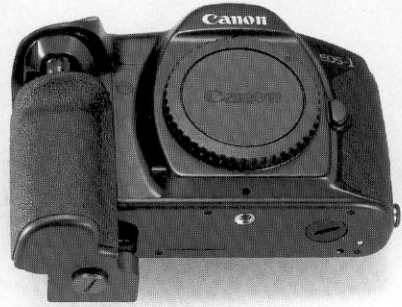

8

Battery Check

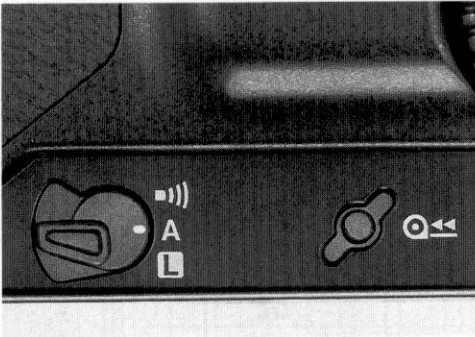

- 1) Set the main switch to "A" or "|||".

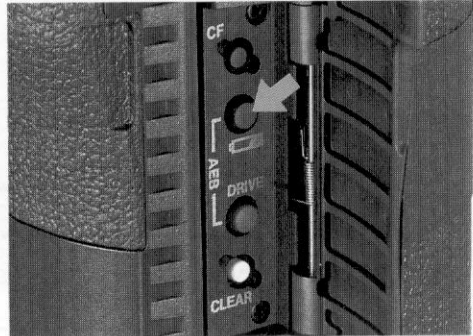

- 2) Open the palm door and press the battery check button.

Battery power is indicated by the number of bars that appear at the bottom of the display panel. For battery shooting capacity, see p. 73.

9

C. Lens Attachment

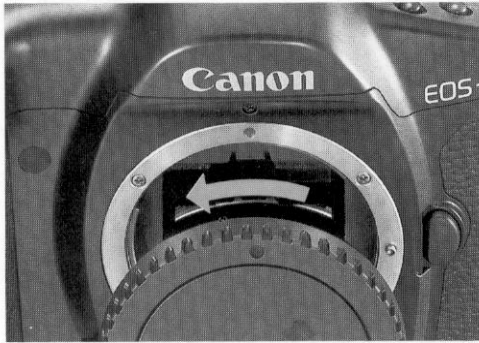

1) Remove the body and rear lens caps by turning them counterclockwise.

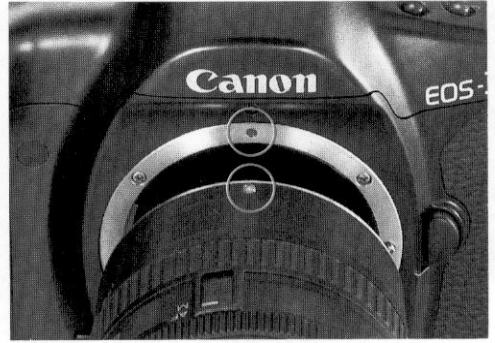

- 2) Align the lens' red dot to the red dot on the camera.
- 3) With the camera facing you, turn the lens clockwise until it stops and locks with a click.
- 4) Remove the front lens cap.

12

Lens Information

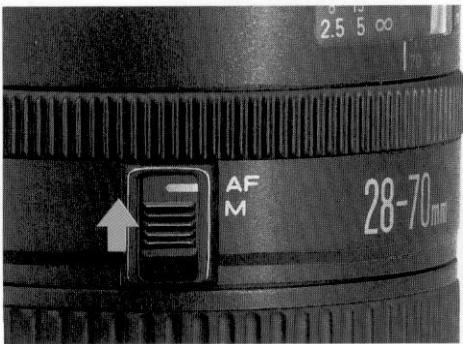

For automatic focusing, slide the lens' focus mode switch to "AF". Set to "M" for manual operation.



• To remove the lens, press the lens release button and turn counterclockwise.

- The electronic contacts must be clean for proper contact. Do not touch these contacts.
- Do not set the lens on its rear end without the lens cap attached to prevent damage to the electronic contacts.

13

D. Dioptric Adjustment

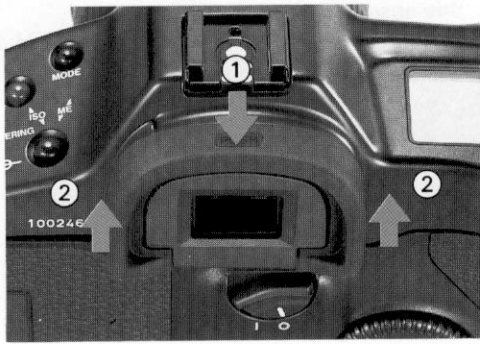

Adjust the eye sight correction to suit your preference. This also allows near or far-sighted users to take pictures without wearing glasses.

- 1) Press on the center of the eyecup frame and push up from the bottom to remove.

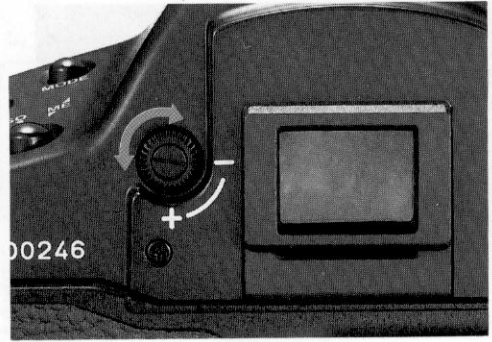

- 2) Look into the viewfinder and turn the dioptric adjustment dial in either direction until the AF frame appears sharp. Be sure to hold the camera firmly. This adjustment may be easier if the camera is mounted on a tripod.

- The adjustment range is from -3 dpt to $+1$ dpt (diopter). For adjustment exceeding this range, use a Dioptric Adjustment Lens optionally available. See p. 66.
- You can check the entire field of view with your eye at maximum 0.8 inch/20 mm away from the viewfinder.

14

E. Focusing

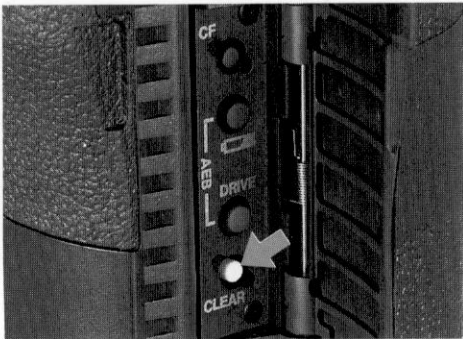

- 1) Open the palm door and press the white mode clear button, marked "CLEAR".



- 2) Center the AF frame "□ □" over the main subject.

15



Shutter Speed Aperture AF symbol
Correct Exposure Index

2) Press the shutter button halfway and automatic focus (AF) starts. When correct focus is obtained, the green AF symbol lights up in the viewfinder.

- Do not touch the front of the lens during focusing.
- When AF is impossible, the green AF symbol starts blinking and the shutter will not release. (See p. 43).
- AF operation is also possible with the AE lock button when using Custom Function Control #4. (See p. 54).
- AF can be done with the Canon Circular Polarizing Filter PL-C.
- If you need the shutter button height or release stroke adjusted, please contact the nearest Canon service facility.

16

F. Display Panel Information

When the white mode clear button inside the palm door is pressed, all controls are cleared and reset to the following conditions at right which appear in the display panel.

See p. 70 for an explanation of the entire display panel.



Display Panel Illumination

Press the display panel illumination button marked above to turn on the light for approximately six seconds. To turn it off within six seconds, press the button again.

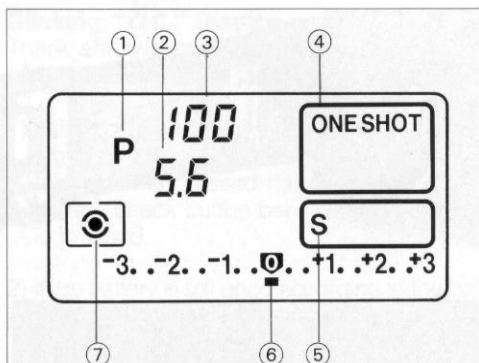

- ① Program shooting mode, see p. 34
- ② Aperture value (appears when the shutter button is pressed halfway, may vary according to the shooting condition)
- ③ Shutter speed (appears when the shutter button is pressed halfway, may vary according to the shooting condition)
- ④ One shot AF mode, see p. 24.
- ⑤ Single frame film winding mode, see p. 22.
- ⑥ Exposure compensation value, see p. 46
- ⑦ Evaluative metering mode, see p. 28.

17

G. Film Load

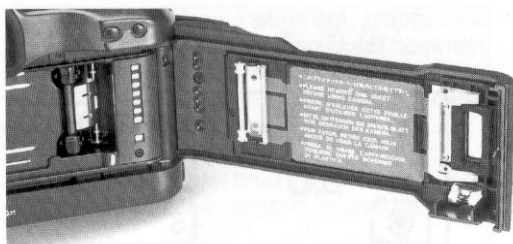

- Before loading the first roll of film, remove the plastic insert.
- *Never touch the shutter curtain.* Its precision design makes it sensitive to pressure. When loading the film, be careful that the film tip does not touch the shutter curtain.

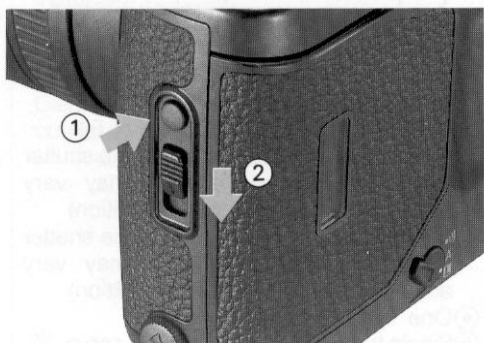

- 1) Open the back cover by pressing the back cover lock button in and sliding the latch down.

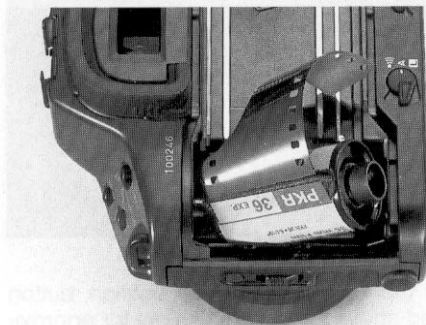

- 2) Insert the flat end of the cartridge into the top of the film chamber. The film cartridge symbol "📷" appears in the display panel.

18

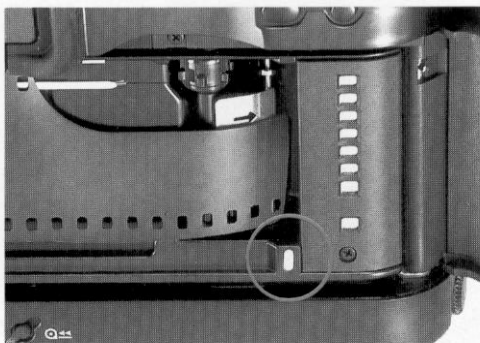

- During film advance, the film transport bars move from left to right at the bottom of the display panel to confirm correct film load.
- *If the bars blink*, film has not been loaded properly and the shutter will not release. Reload the film.

- Film becomes soft and tears easily in high humidity. Keep it stored in its canister until loading.

- 3) Carefully pull the film tip across until it reaches the orange mark.
- 4) Make sure the film lies flat and close the back cover. The film will automatically advance to the first usable frame and "1" appears in the frame counter.

19

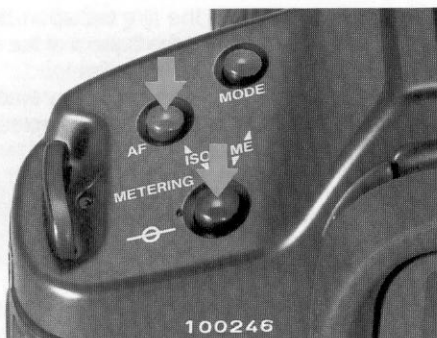

The film speed for DX-coded film is automatically set according to the code on the cartridge from ISO 25-5000. The film speed will appear in the display panel while the film advances to the first usable frame.

For non DX-coded film, set the film speed from 6-6400 by pressing both the AF mode and metering buttons while turning the main dial until the desired speed appears.

To override the DX-code setting, please see Custom Function #3 on p. 54. This will cancel the automatic setting for manual input.



- When using *non-DX film cartridges*, the previously set film speed blinks in the display panel to warn that the correct film speed may not have been set. This warning stops after the two buttons marked "AF" and "METERING" on top of the camera have been pressed. If you want to change the ISO setting, turn the main dial while pressing these buttons.

20

H. Film Rewind

Film rewind starts automatically at the end of the roll. The film leader is *completely rewound* into the cartridge. The film rewind time is about 8 seconds with 24-exp. film.

- Auto rewind may be canceled by setting Custom Function #1. (see p. 54). In this case rewind is started by pressing the film rewind button.
- The film leader may be left out by setting Custom Function #2. (see p. 54).

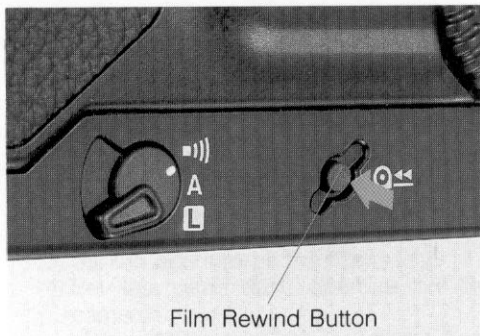

Film Rewind Button

I. Film Winding Mode

There are two film winding modes. To set the film winding mode, press the blue button marked "DRIVE" (behind the palm door) and turn the main dial.

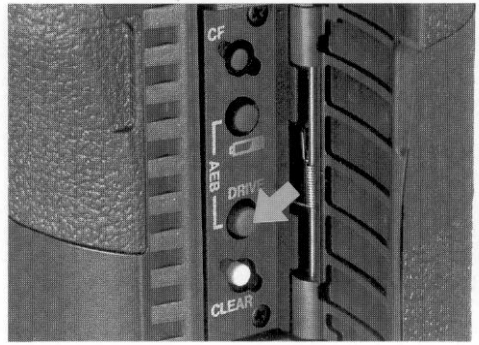

22

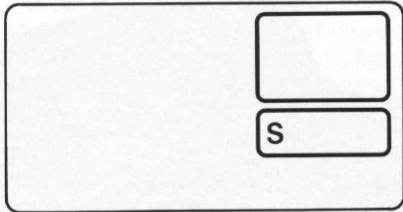

S- Single, film automatically advances to the next frame after exposure.

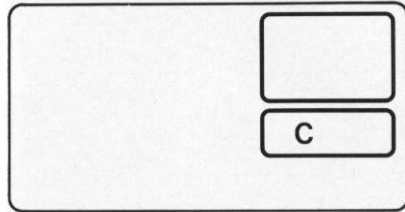

C- Continuous, advances at 2.5 fps. when the shutter button is held.

When the Power Drive Booster E1 accessory is attached, the continuous icon "C" changes to:

- C_L**—(low) film winds at a maximum 3 fps. (approximate)
- C_H**—(high) film winds at a maximum 5.5 fps. (approximate)

The power drive speed automatically changes from high to low when its batteries are weak to conserve energy. The icon blinks in the display panel to warn you.

Continuous Film Winding Speed Comparison

Mode	One Shot AF Mode	AI Servo AF Mode
C	2.5 fps.	2 fps.
C _L	3	2.5
C _H	5.5	4.5

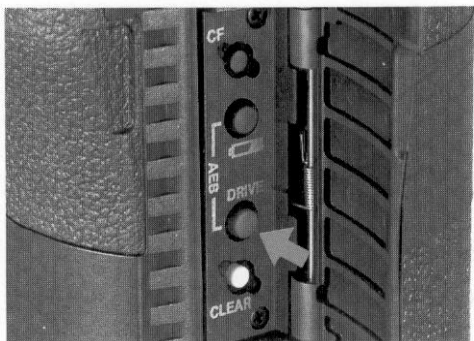

The self-timer has two release delays, 2 or 10 seconds. Choose to minimize the risk of camera-shake in critical situations, or to put yourself in the picture.

- 1) Open the palm door and press the blue button marked "DRIVE".



- 2) Turn the main dial until the self-timer mark with the desired release delay appears.
- 3) After composing, press the shutter button halfway to confirm focus and exposure.
- 4) Press completely to start the timer.

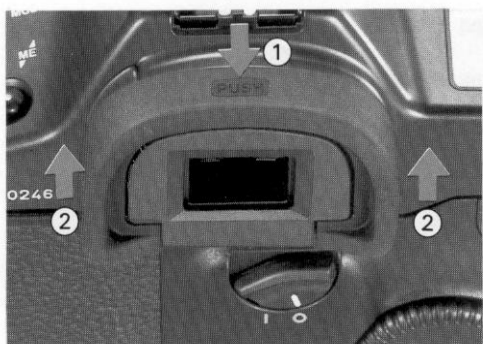

If your eye will not be at the viewfinder when you press the shutter button completely, use the viewfinder cover to prevent stray light from entering.

- 1) Press the center of the eyecup frame and push up from the bottom to remove.

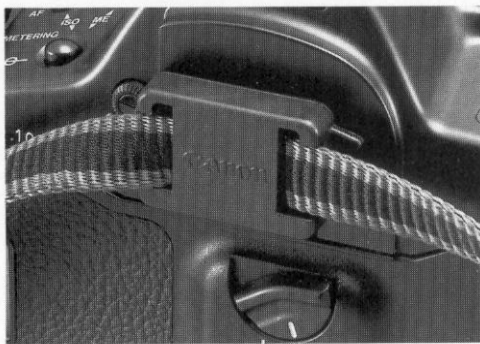

- 2) Attach the viewfinder cover.

- The viewfinder cover also serves as a tool to press the buttons inside the palm door and to turn the grip screw.

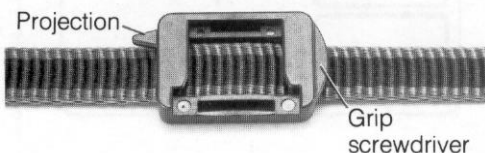

J. Setting the AF Mode

There are two autofocus (AF) modes; ONE SHOT and AI SERVO plus manual focus (M. FOCUS).

Set the AF mode by pressing the AF mode button on top of the camera and turning the main dial.

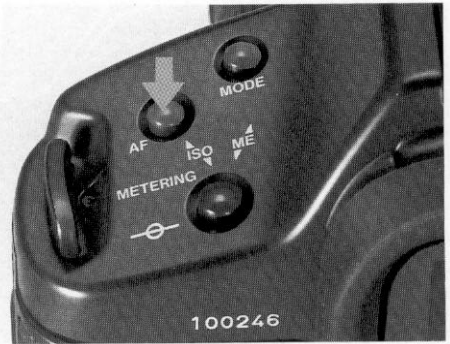

26

ONE SHOT—The lens stops moving when the subject is in focus. The shutter releases only after the subject is in focus. When the shutter button is pressed halfway, focus and exposure are locked. The AF symbol in the viewfinder and the optional beeper tone confirm focus completion.

•When Custom Function #4 is selected (AF start by pressing AE lock button), the shutter can be released in one shot AF mode regardless of whether the subject is in focus or not. (See p. 54).

AI SERVO—The lens continues to refocus as the shooting distance changes. The shutter releases regardless of whether the subject is in focus or not. Exposure is determined at shutter release. The AF symbol and beeper tone are cancelled.

Set the lens for **manual focus** by switching the lens' focus mode switch from "AF" to "M".

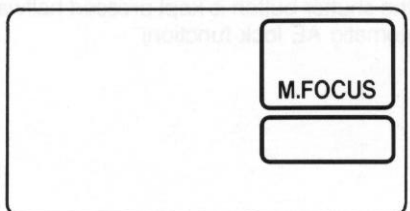
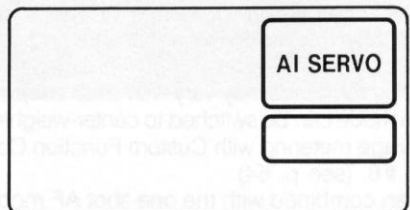
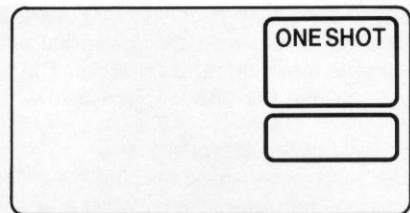

27

K. Setting the Metering Mode

To select the metering pattern that best suits the shooting condition, turn the main dial while pressing the metering mode selector. The display changes in the order written below.

: Evaluative Metering

This metering mode measures light in six different areas of the picture frame while analyzing subject size, pattern and ambient light. An emphasis is placed on the center of the picture frame. Use this mode in normal shooting conditions.

- The performance may vary with small subjects.
- This mode can be switched to center-weighted average metering with Custom Function Control #8. (see p. 54).
- When combined with the one-shot AF mode, the original exposure remains locked as long as the shutter button is kept pressed halfway. (Automatic AE lock function)

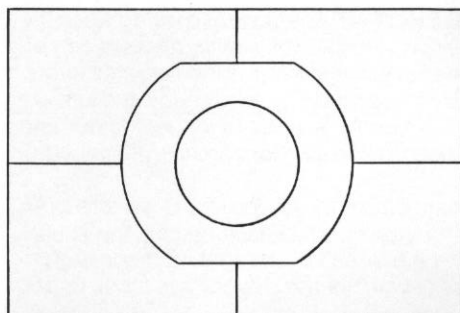

6 zones of Evaluative Metering

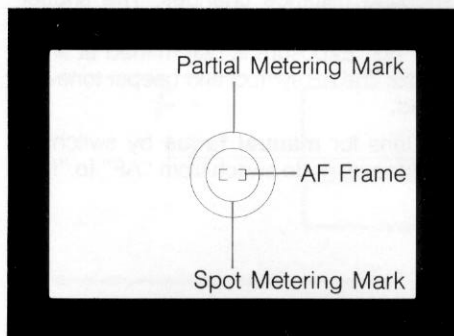

28

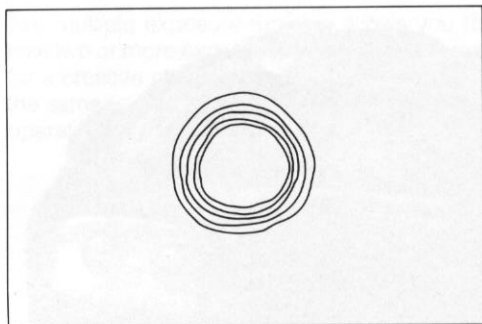

Partial Metering Sensitivity Pattern

: Partial Metering

This metering mode measures approximately 5.8% of the picture frame. It is marked on the focusing screen by the outer circle. Use this mode for stage photography or when there is a big difference in brightness between the main subject and the background.

- Even when combined with the one-shot AF mode, exposure is determined at shutter release. For pictures with the subject off-center, please see p. 30 for "AE Lock Photography".

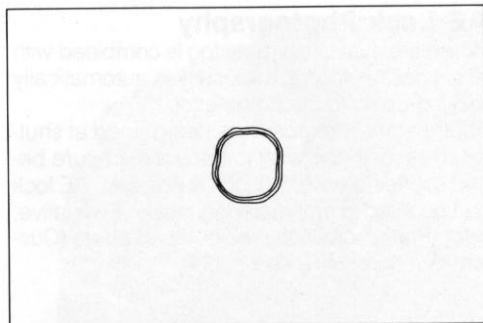

Spot Metering Sensitivity Pattern

: Spot Metering

This metering mode measures approximately 2.3% of the picture frame. It is marked on the focusing screen by the inner circle near the AF frame. Use this mode for subjects which require precise measurement, such as macro photography.

- Even when combined with the one-shot AF mode, exposure is determined at shutter release. For pictures with the subject off-center, please see p. 30 for "AE Lock Photography".

29

AE Lock Photography

When the evaluative metering is combined with one shot AF mode, exposure is automatically locked upon focus completion.

At other times, exposure is determined at shutter release. If you wish to control exposure before shutter release, AE lock is possible. AE lock can be used in any metering mode: Evaluative, Spot, Partial, or Center-weighted average (Custom Function #8, see p. 54).



1) Focus the subject and start metering by pressing the shutter button halfway.

2) Lock the exposure by pressing the AE lock button on the back of the camera. The AE lock indicator \star appears in the viewfinder. Recompose the picture while keeping the shutter button pressed halfway.

AE Lock



- You can remove your thumb from the AE lock button if you keep the shutter button pressed *halfway*. Exposure will be locked at the value displayed in the viewfinder and on the display panel.



3) Press the shutter button all the way to take the picture.

- After the picture has been recomposed, both the current and the locked exposure values appear in the viewfinder on the right side in the exposure scale.

- See p. 69 for an explanation of all viewfinder data.

ESSENTIAL OPERATIONS



L. Setting the Shooting Mode

There are five shooting modes plus bulb that are set by pressing the mode button and turning the main dial. The modes change in the order below:

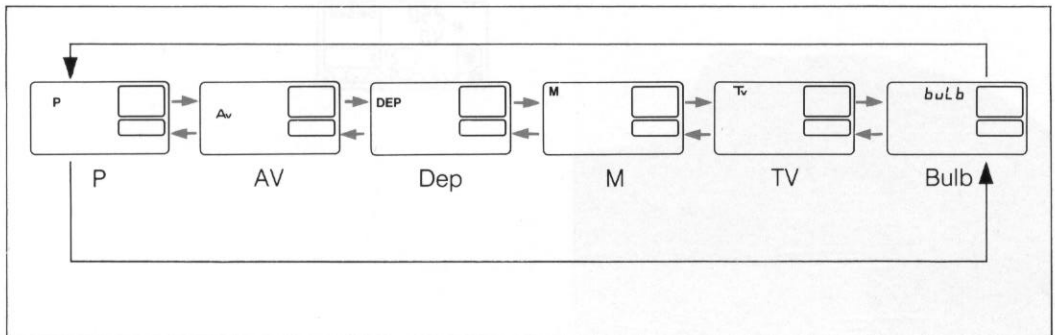
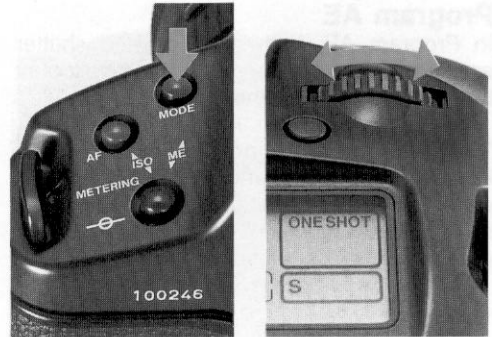

Program AE

In Program AE, both aperture and shutter speed are automatically set taking into account the characteristics of the lens in use.

Viewfinder Information

If the shutter speed and aperture blink, exposure will be incorrect. Use a neutral density filter in bright settings or switch to flash photography in dark settings.

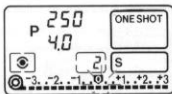

Program Shift

To adjust the aperture or shutter speed in Program AE, turn the main dial. This adjustment will clear after one exposure.

- Program Shift cannot be used with a flash.
- See p. 72 for program shift characteristics.

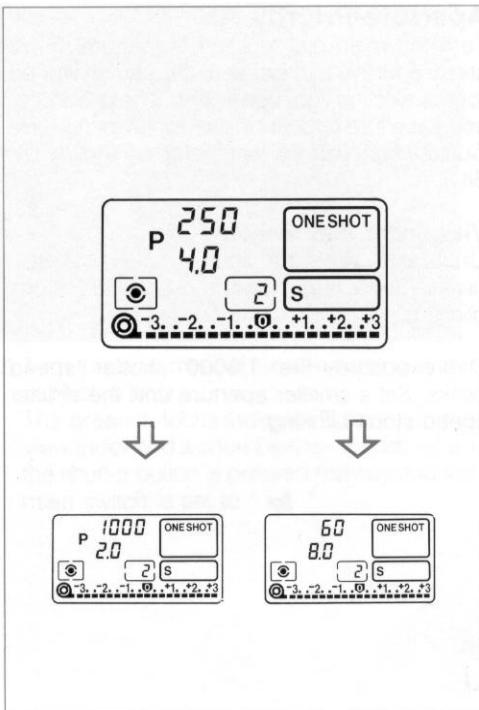

Aperture-Priority AE

Turn the main dial to set the aperture in 1/3 steps and the camera sets the shutter speed for the existing light conditions. The previously used aperture appears in the display panel. Use Custom Function #6 for full-step setting, see p. 54.

Viewfinder Information

Underexposure—the shutter speed of 30" blinks. Set a larger aperture until 30" stops blinking.

Overexposure—the 1/8000 shutter speed blinks. Set a smaller aperture until the shutter speed stops blinking.

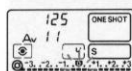
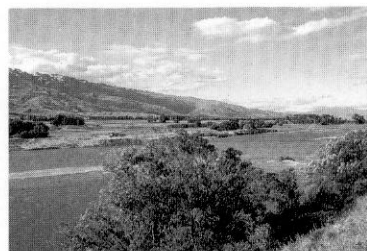

Shutter-Priority AE

Turn the main dial to set the shutter speed in 1/3 steps and the camera sets the aperture for the existing lighting conditions. The previously used shutter speed appears in the display panel. Use Custom Function #6 for full-step setting, see p. 54.

Viewfinder Information

Underexposure—the lens' maximum aperture starts blinking. Set a slower shutter speed until it stops blinking.

Overexposure—the lens' minimum aperture starts blinking. Set a faster shutter speed until it stops blinking.

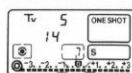
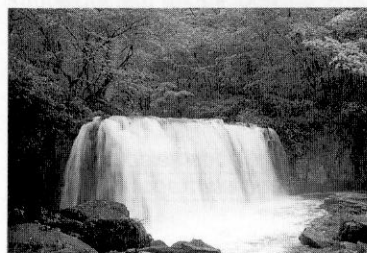
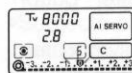

Depth-of-Field-AE

This mode places everything between two user-set points in the foreground and background in focus. The camera sets the necessary aperture and shutter speed to obtain the best possible exposure under the existing lighting.

•This mode cannot be used with flash.

- 1) Put the AF frame over the subject in the foreground (A) and press the shutter button halfway.
- 2) Remove your finger when the AF symbol and "dEP 1" light up.
- 3) Repeat steps #1 and #2 for the subject in the background (B) ("dEP 2").
- 4) Reframe the picture and press the shutter button halfway. After the AF symbol and shooting values light up, press the shutter button completely.

•Press the shooting mode selector to clear all focus points and start again.

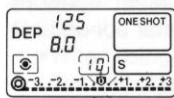
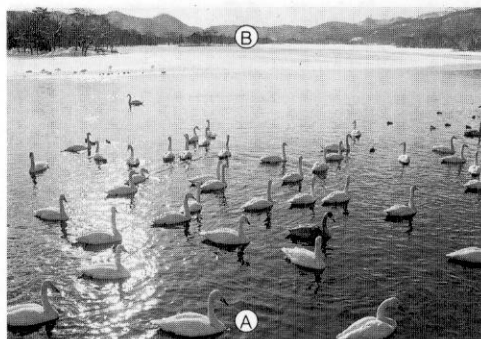

Viewfinder Information

If the minimum aperture is blinking, clear the focus points, move back from the subject, and repeat steps #1 through #4. When the aperture stops blinking, the distance range will be sharply focused and correct exposure obtained.

Additional Information

- A. If the minimum aperture continues to blink, the distance range is too deep for sharp focus. The exposure will produce the best possible results under the existing conditions.
- B. Wide-angle lenses are best used in this setting for maximum depth-of-field effect. Lenses longer than 200 mm are not recommended for deep depth of field.
- C. This mode can also be used to minimize depth of field by focusing on the same point both times. A telephoto lens gives portraits the best shallow depth of field effect.
- D. If both values blink, exposure is incorrect. Use a neutral density filter in bright settings.
- E. If the focus points are extremely near and far, the shutter speed may be very slow. Hold the camera steady, or use a tripod.
- F. Do not change the focal length after setting the first focus point on a zoom lens. Always set the focal length first.
- G. In this mode, exposure is determined at shutter release even with the combination of one shot AF mode and evaluative metering.

Manual Exposure

Maintain complete control of the exposure with this mode by setting the shutter speed and aperture. The main dial sets the shutter speed and the quick control dial sets the aperture. This setting method can be reversed if desired with Custom Function #5. The correct exposure is indicated in the viewfinder on the right side.

- Be sure that the quick control dial switch is set to " | ".

The previously used shutter speed and aperture value appear in the display panel.

The letter M appears to the left of the shooting values at the bottom of the viewfinder.

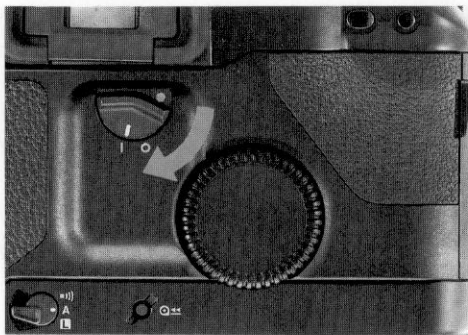

40

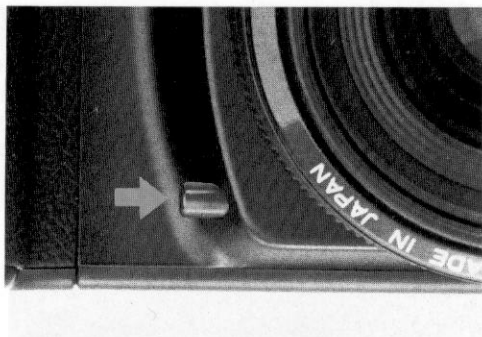

Depth-of-Field Preview

Push the depth-of-field button and the camera will stop-down the aperture allowing you to see the range of sharpness.

41

Bulb

Use this mode for long exposures, as in astro or night photography. Set the aperture value with the main dial. There is no exposure warning in this mode. The operation time is represented by three bars and numbers from 1 - 30 which appear in the display panel. Each bar mark represents 30 seconds. The maximum time display is 120 seconds.

- Use a tripod and Remote Switch 60T3 (available optionally) for long exposures.
- The accessory Command Back E1 (available optionally) controls the exposure time within a period of 23 hours 59 minutes.
- Bulb cannot be used with auto exposure bracketing.
- This mode requires very little power for minimal battery drain.

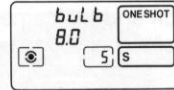

5 sec display

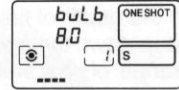

31 sec display

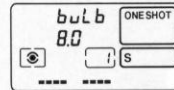

61 sec display

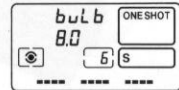

96 sec display

M. Difficult Subjects for Autofocus

Although the AF system of the camera is very accurate, it is not perfect. The following subjects are difficult for autofocus. When AF is impossible, the green AF symbol will blink in the viewfinder.

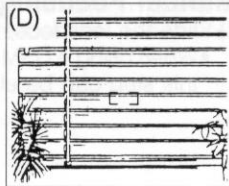
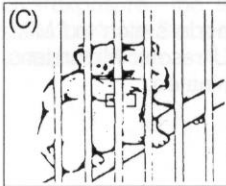
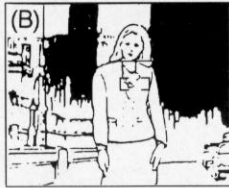
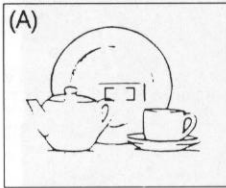

SUBJECTS

- Low contrast subjects (misty scenes, light-colored, or white objects) (A)
- Subjects in extremely low-light situations (a dark room, night scenes) (B)
- Subjects with an object in front of them (caged zoo animals) (C)
- Subjects having generally horizontal patterns (D)
- Subjects with bright spectral reflections (shiny metal, snow, ice, surface of a lake)
- Subjects in extremely strong backlight
- Fast-moving subjects (difficult to keep within the AF frame)

Focus these subjects as follows:

1. Focus on a substitute subject at the same distance from the camera as your main subject, and then recompose the picture using focus lock function (A)
2. Hold the camera vertically, focus the subject, and then recompose the picture using focus lock function (D)*
3. Manually focus the subject following the steps at right.

*When using a lens with a maximum aperture of f/2.8 or larger (except EF 50 mm f/2.5 compact macro and EF 28-80 mm f/2.8-4.0L), vertical composition is not necessary.

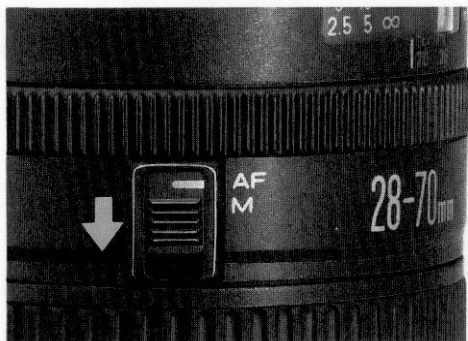

Manual Focusing

- 1) Slide the lens focus mode switch to "M".
 - When using a USM (Ultrasonic Motor) lens, this step can be eliminated.

Manual Focusing

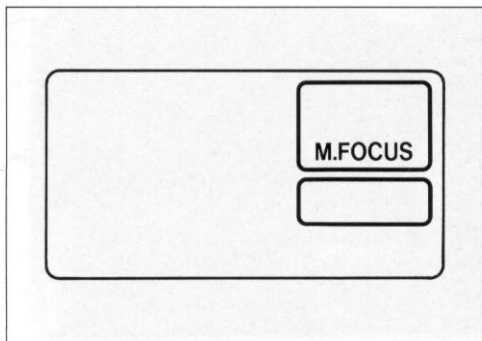

- 2) The display panel automatically changes to "M. FOCUS" and the AF mode cannot be set.

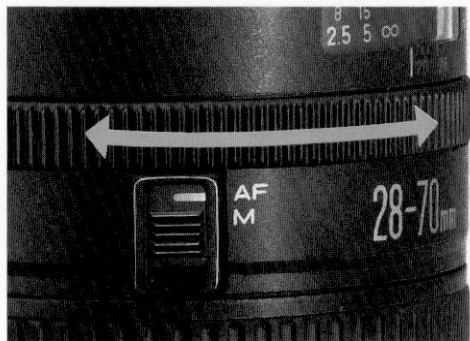

- 3) Turn the lens' manual focusing ring until the subject is sharp.
The green in-focus indicator lights up in the viewfinder and a short beeper sounds when the shutter button is pressed halfway and the main switch is set to " ".

N. Exposure Compensation

Use exposure compensation for intentionally underexposed (low-key) or intentionally overexposed (high-key) pictures. The range of exposure compensation is up to ± 3 steps in $1/3$ -step increments.

- 1) Set the quick control dial switch to "I".
- 2) Look into the viewfinder and press the shutter button halfway.
- 3) Turn the quick control dial to the desired compensation amount. The dial must be turned within six seconds after the shutter button has been pressed halfway. It is effective when taking vertical composition pictures with the Power Drive Booster E1 (optionally available) attached.

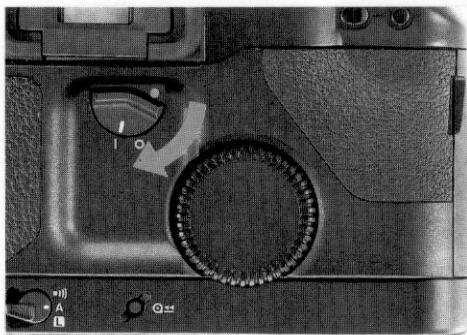

46

- An exposure compensation value can also be set by turning the main dial while pressing the exposure compensation button.
- 4) Press the shutter button all the way to take the picture.
 - The "±" mark indicating exposure compensation status appears in the viewfinder.
 - The value can be confirmed both in the viewfinder and on the display panel as shown on the next page.

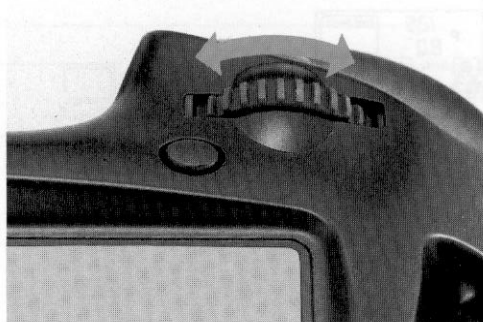

47

Exposure Compensation Information

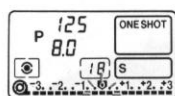
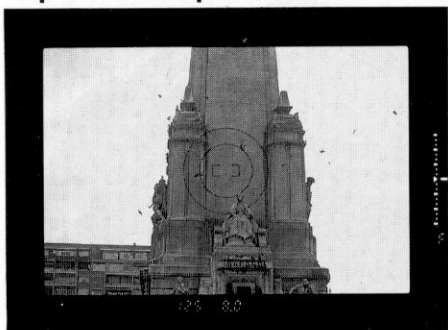

No compensation applied

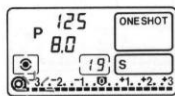

-3 steps of compensation applied

48

O. Auto Exposure Bracketing (AEB)

Use auto exposure bracketing to produce a sequence of three pictures to vary the rendition of the subject intentionally by changing the exposure. The range of bracketing is up to $+/-3$ steps in $1/3$ -step increments. *You control the timing of shutter release for each individual exposure in the AEB sequence.*

- Auto exposure bracketing is impossible with a flash.

- 1) Open the palm door and press both the film winding mode selector and the battery check button simultaneously to display "AEB" in the display panel.

- The display will stay on for approximately six seconds so you can remove your fingers from the buttons.

- 2) Turn the main dial to the desired bracketing amount. If you set 2 in the display panel, for example, you can take three exposures in the sequence of -2 steps, normal, and $+2$ steps over the correct exposure according to the camera's meter.

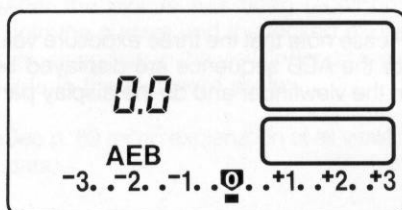

49

- The AEB function remains active until you decide to cancel it. **To cancel AEB at any time, turn the main switch to “L”.**
- Do not set an amount that will exceed the maximum or the minimum aperture value of the lens in use or that will exceed either 1/8000 second or 30 seconds shutter speed.
- To shift the bracketed exposure value toward overexposure or underexposure, you can combine exposure compensation with AEB. Be sure to set the bracketing amount before setting the exposure compensation amount.
- Please note that the three exposure values for the AEB sequence are displayed both in the viewfinder and on the display panel.
- During the AEB sequence, the “AEB” mark on the display panel blinks as does the “✕” mark in the viewfinder.
- When using manual exposure mode, you may select either aperture value or shutter speed as the variable setting in the AEB sequence by setting Custom Function #5. (see p.54).
- To take three continuous exposures, of a moving subject with AEB, for example, set the film winding mode to C (continuous exposure) and keep pressing the shutter button all the way down.

P. Multiple Exposures

The multiple exposure function allows you to take two or more exposures on the same frame for a creative effect. Up to nine exposures on the same frame can be preset with the simple operation of the main dial.

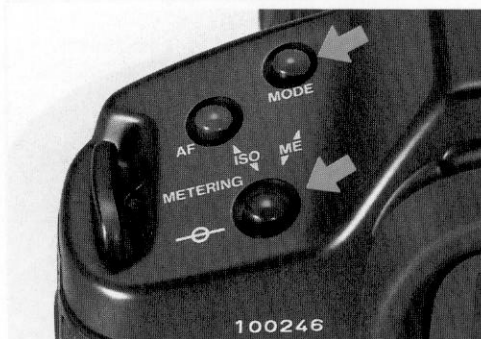

- 1) Press both the shooting mode selector and the metering mode selector simultaneously. The “ME” mark indicating multiple exposure status appears in the display panel and the frame counter starts at “1” indicating the number of exposures.



Clearing Preset Exposures

1. Before Shooting
Follow steps # 1 and # 2 on pp. 51 ~ 52 and turn the main dial to return the frame counter to "1".
2. During Shooting
Follow the same procedures as above and turn the main dial until the frame counter is blank.

Be sure to set exposure compensation depending on the number of exposures for best results.

Number of exposures	Exposure Compensation Setting
Double	- 1.0
Triple	- 1.5
Quadruple	- 2.0

- 2) While pressing both, turn the main dial to the desired number of exposures. For example, set "3" on the frame counter if you want to make three exposures on the same frame.
 - "ME" blinks during multiple exposures.
 - After the preset number of exposures have been completed, the film automatically advances to the next frame.

Multiple Exposure Information

Information

1. The preceding table is a general guideline. The actual amount of exposure compensation varies according to the situation. Your technique will benefit greatly from practice.
2. It is not advisable to make multiple exposures on the first or last several frames due to possible film curl which may adversely affect image registration.
3. Generally, the first exposure of a series should be a relatively dark subject so that the image in the next exposure will show up clearly.
4. When using print film, please inform the developer that you have taken multiple exposures, or your photos may be processed incorrectly.



Q. Custom Function Control

This versatile control lets you program eight functions to your individual preference.

- 1) Open the palm door and press the custom function set button marked "CF".
The control number "F-1" and "0" appear in the display panel.

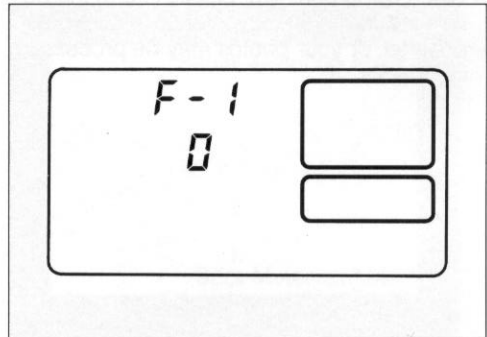
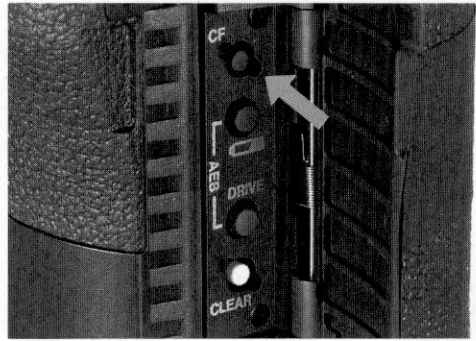

54

- 2) Turn the main dial in either direction to set the desired control number.
- 3) Press the custom function set button again to finish. "0" turns to "1" indicating that the function is set.
 - **To cancel a control** and return to normal operation, repeat the above steps. "1" returns to "0".
 - **To cancel all functions** at a once, open the palm door and press the white button marked "CLEAR".
 - See p. 17 for a complete explanation of other operations affected by the "CLEAR" button.

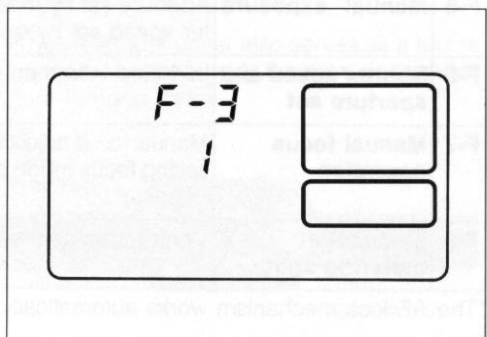

55

Custom Function Control Chart

Control		User-selected Operation (1)	Normal Operation (0)
F-1	Film rewind cancellation	Cancels automatic film rewind operation.	Film rewind starts automatically at end of roll.
F-2	Film leader out	Leaves the film leader outside the cartridge.	Film leader completely rewound into cartridge.
F-3	Film speed set	Allows manual film speed setting of DX-coded film.	Film speed set by camera according to DX-code.
F-4	Autofocus start	Initiates autofocus by pressing AE lock button, suitable for focus lock function.*	Autofocus starts when shutter button pressed halfway.
F-5	Manual exposure	Aperture set by main dial and shutter speed set by quick control dial.	Shutter speed set by main dial and aperture set by quick control dial.
F-6	Shutter speed and aperture set	In 1-step increments	In 1/3-step increments
F-7	Manual focus operation	Manual focus adjustment possible by setting focus mode switch with USM lenses.	Allows manual focus adjustment after autofocus with USM lenses, without prior setting.
F-8	Evaluative metering shift	Center-weighted average metering	Evaluative metering

*The AE lock mechanism works automatically.

56

Special Film Usage

Shooting with Infrared Film

When using black and white infrared film, make a slight adjustment in focus with the red infrared index. For example, focus the subject first, then, if the lens is focused at 5 m on the distance scale, turn the manual focusing ring to align the 5 m mark with the red dot and release the shutter. For zoom lenses, use the small red lines to align with the number as shown.

- Use a deep red filter as specified by the manufacturer.
- The infrared index mark position has been computed for infrared film usage with peak sensitivity at 800 nm.
- Follow the manufacturer's instructions when using color infrared film.

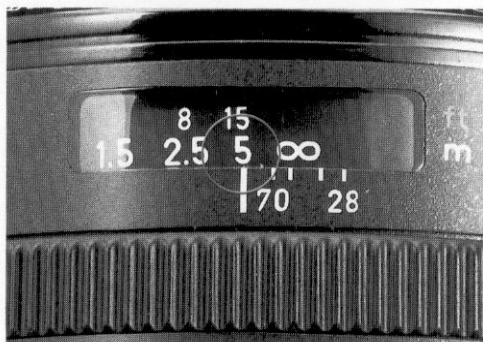

57



58



X-sync shutter speed | Flash-charge completion mark
Aperture

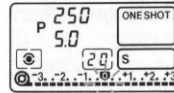

- (1) Use the Canon Speedlites 430EZ and 300EZ for fill-in flash in outdoor settings as well as for normal flash when shooting at night or in a dimly-lit room. These units feature a built-in AF auxiliary light function for dark situations.

- When the AF mode is set to AI servo, the AF auxiliary light does not emit.

After flash charge completion in the Program AE mode, the aperture and the x-sync shutter speed are automatically set. the x-sync shutter speed is set between 1/60 and 1/250 sec.

Please refer to the Speedlite's instruction book for further details.

- (2) Other Canon Speedlites:

Follow the steps below for automatic flash photography:

- 1) Set the camera's shooting mode to "M".
- 2) Set the desired X-sync shutter speed between 30 sec. and 1/250 sec.

- If the shutter speed is set faster than 1/250 sec, it is automatically reset to 1/250 sec.

- 3) Set the aperture on the flash.

- 4) Set the same flash aperture on the camera.

- When using the 300TL, set the flash mode set button to A-TTL or FEL for TTL automatic flash photography.

- Do not use the 277T and 299T in the "PROGRAM" mode. Be sure to set the flash to "F. NO. SET" mode.

- The 244T cannot be used.

(3) Other Manufacturers' Flashes

The X-sync speed can be set to 1/250 or slower.

- With a large, studio-type flash, be sure to confirm correct synchronization before use as flash duration may vary.
- When using flash with a synchronization cord, attach its connecting plug to the camera's PC terminal.
 - The PC terminal only has an X-sync contact. The X-sync shutter speed can be set to 1/250 sec. or slower.
 - When using studio flash units or when using wireless syncro devices, perform a film test to verify the maximum usable sync speed with your equipment.
 - Direct contacts and the PC terminal can be used simultaneously.
 - Use a *Canon Speedlite with the EOS-1*. Using a flash (usually with more than two contacts) or flash accessory of another manufacturer may cause malfunction or damage.

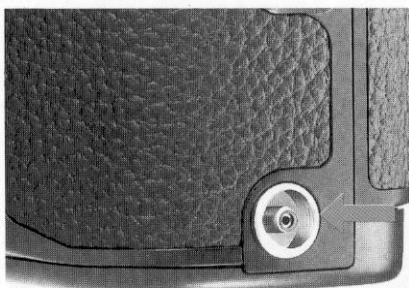

OTHER INFORMATION

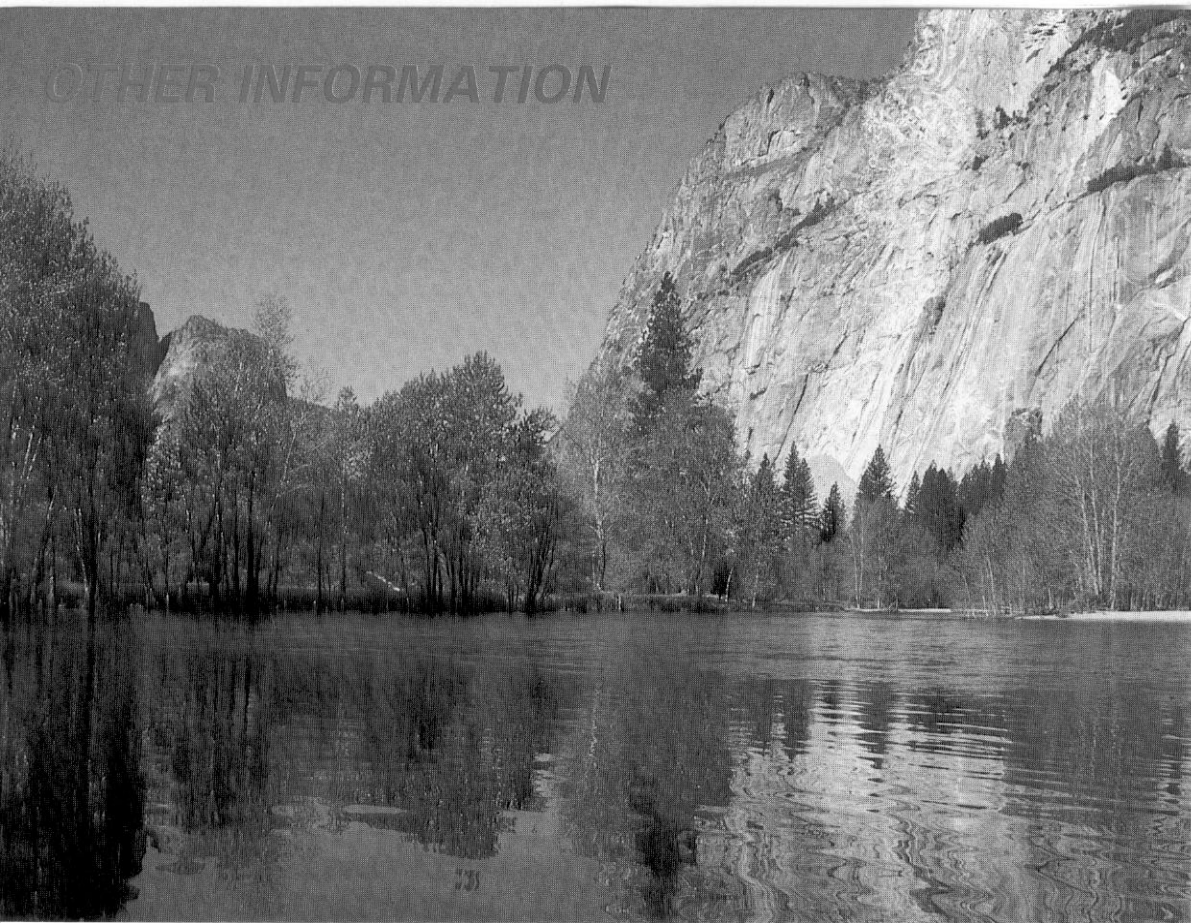

Lithium Battery

The camera requires one, 6-volt lithium battery (2CR5). Always check the battery at the following times:

1. When loading a new battery
2. Before an important shooting task
3. If the shutter will not release
4. In cold weather
5. After prolonged storage

Battery Use Information

1. Wipe the battery terminals and the camera contacts with a clean, dry cloth before loading to ensure proper contact.
2. Remove the battery if you do not expect to use the camera for more than three weeks.
3. Battery performance deteriorates slightly in temperatures below 32°F/0°C. Keep the camera and especially a spare battery close to your body or in an inside pocket to keep them warm until use.

4. The battery may explode or cause burns if disassembled, recharged, shorted, or exposed to high temperature or disposed of in fire. Be sure to observe all precautions indicated on the battery package. Always keep it out of the reach of children.

5. If one blinking bar or no bar mark appears in the display panel during battery check, exposure will be correct as long as the shutter releases. Automatic advance and rewind will be impaired by insufficient battery power. If film wind or rewind stops due to the battery, the film transport bars will blink. Film transport operations will resume after a new battery is installed and the film rewind button pressed.

Liquid Crystal Display

The display panel uses liquid crystal to indicate exposure information. After about five years, the display may become difficult to read. If this occurs, have it replaced at an authorized Canon service facility. Replacement is at the owner's expense.

Liquid crystal may also respond relatively slow in temperatures below 32°F/0°C, or become dark in temperatures around 140°F/60°C. The display panel will return when the temperature returns to normal.

Blinking "bc" Display

There are two conditions when the blinking "bc" in the display panel will appear:

- 1) If the battery is nearly exhausted, the blinking "bc" display will appear when the shutter button is pressed halfway or when the battery check button behind the palm door is pressed.
- 2) If the battery is still good according to the battery check button, but the camera's self testing process detects an internal malfunction, the blinking "bc" will appear when the shutter button is pressed halfway.*

*In this case, try removing the battery completely, reinserting it and then pressing the battery check button.

If the blinking "bc" still appears, the camera needs to be examined by an authorized Canon service facility.

T. Camera Care

As with any precision instrument, *proper care* involves a few guidelines and good common sense. Observing them will keep your camera in top condition at all times. We recommend cleaning your camera periodically.

Cleaning tools: blower brush, lens cleaning fluid, lens cleaning tissue, silicone-treated cloth.

- 1) To clean the lens surface and the viewfinder eyepiece:

Blow off dust with a blower brush and gently wipe the lens surface with a lens cleaning tissue slightly moistened with lens cleaner. Clean in a *spiral motion* from the center outwards.

- 2) To clean the reflecting mirror and focusing screen:

Use only a blower brush reserved for this use only. If more cleaning is necessary, NEVER attempt to do it yourself, take it to an authorized Canon service facility.

- 3) To clean the film chamber:

Use a blower brush to occasionally remove accumulated film dust particles that might scratch the film.

- 4) To clean the film pressure plate and the film guide rails:

Lightly wipe the surface with a lens cleaning tissue moistened with lens cleaning fluid.

64

U. Accessories



Speedlite 430 EZ

Designed with advanced features that complement the EOS-1, (at ISO 100, this flash boasts a powerful guide no. of 141-ft/43-meters). An external battery pack can be attached when the shooting situation calls. The 430 EZ utilizes A-TTL output and has a 1/250 sec. sync. speed for a wide variety of photos and fill-in flash. Lastly, a built-in exposure compensation function gives you more control than ever.



Power Drive Booster E1

This motor drive unit increases the maximum film winding speed to 5.5 frames per second with power supplied by eight, AA-size batteries. It is designed for improved operability with features such as a separate shutter button and AE lock button for easy vertical shooting. An adjustable padded hand strap (optionally available) assures a secure grip on the camera.

65

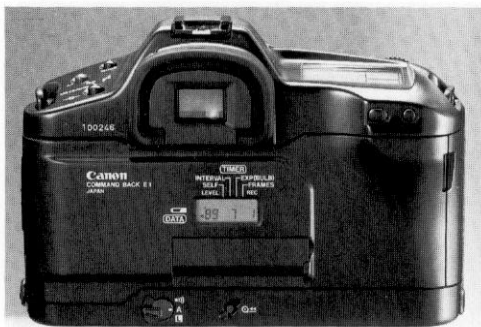

Command Back E1

This interchangeable back is exclusively for the EOS-1 and provides control for different types of timed photography. It also prints the date or time, a 6-digit arbitrary code, frame counter number, and the letters A through F.

Dioptic Adjustment Lenses

These lenses provide more adjustment if the built-in -1 ± 2 dpt. range is insufficient. There are 10 correction lenses available. Be sure to conduct a trial test for the best match to your eyeglass prescription.

Focusing Screens Ec

Seven interchangeable focusing screens are available to suit various applications. Each comes with a special tool for simple installation.

These focusing screens are exclusively designed for EOS-1.

A. Microprism

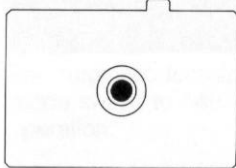

Matte field with microprism rangefinder spot in the center of the screen. Usable with all lenses. Especially suited for general photography using an aperture of f/5.6 or larger.

B. New split

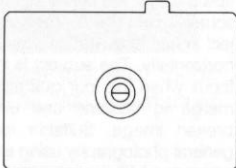

Matte field with split-image rangefinder spot in the center of the screen. Suitable for all lenses.

C. Laser-matte with AF frame

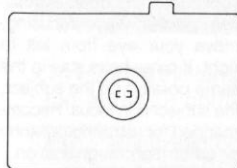

Matte field with AF frame in the center of the screen. This screen enables the entire field of view to be seen without distraction. Usable with all lenses. Installed at assembly.

D. Laser-matte with section

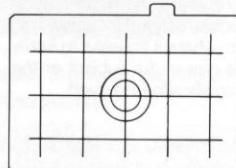

Matte field with vertical and horizontal reference lines. It is best for architectural photography, etc. where accurate image placement is essential.

H. Laser-matte with scale

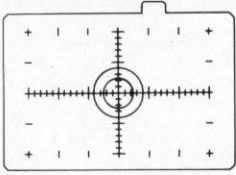

Matte field with vertical and horizontal scale in millimeters. Recommended for close-ups, etc. where it is useful to know the size of the subject or the magnification involved.

I. Laser-matte with double cross-hair reticle

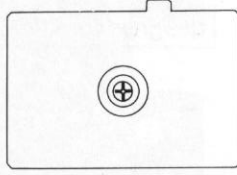

Matte field with clear center spot containing double cross-hair reticle. While focusing, move your eye from left to right. If cross-hairs stay in the same position on the subject, the subject is in focus. Recommended for astrophotography or other high magnification.

L. Cross split-image

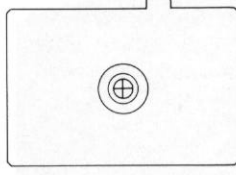

Matte field with cross splitimage in the center of the screen which divides the subject in half both vertically and horizontally. The subject is in focus when the four quarters merge to become one unbroken image. Suitable for general photography using an aperture of f/5.5 or larger.

V. APPENDIX

Viewfinder Information

The bright and easy-to-read viewfinder displays only necessary information at the bottom and the right side. The diagram here shows all the information for explanation only. All the information never actually appears simultaneously.

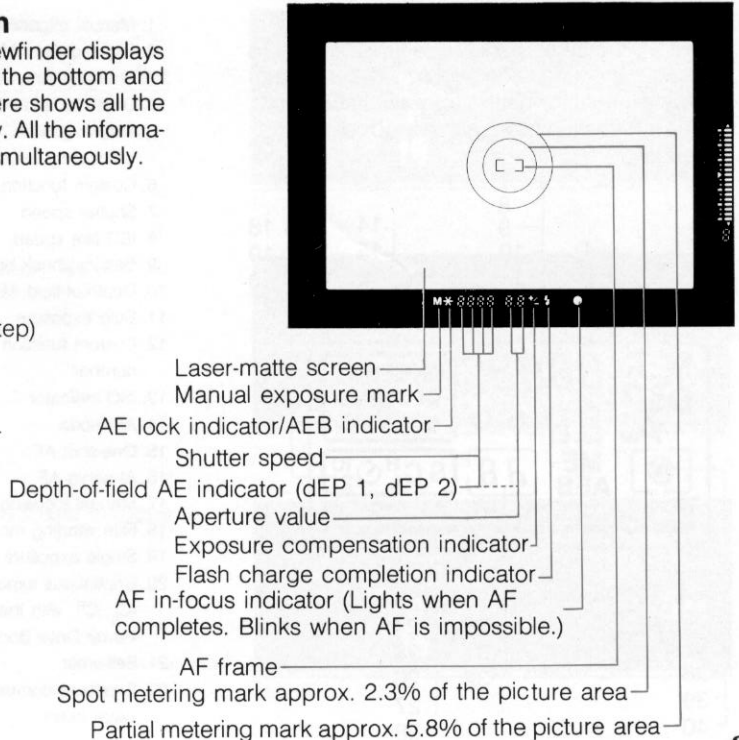
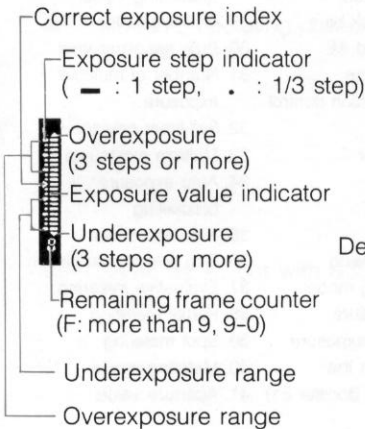

Display Panel Information

The EOS-1 display panel uses liquid crystal to indicate shooting conditions. This diagram shows all the information for explanation only. All the information never actually appears simultaneously.

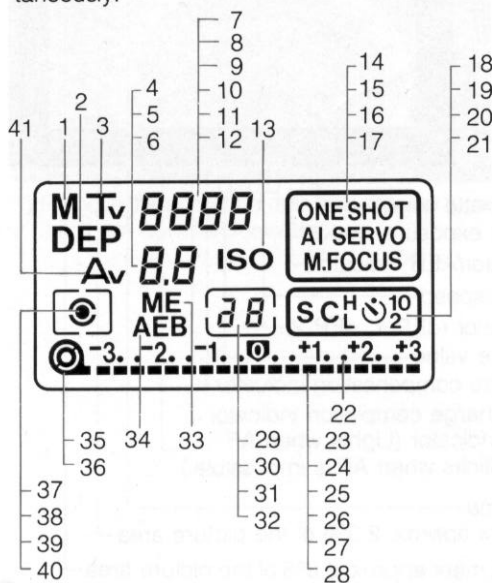

70

1. Manual exposure
2. Depth-of-field AE
3. Shutter-priority AE
4. Depth of field AE
5. Auto exposure bracketing value
6. Custom function control
7. Shutter speed
8. ISO film speed
9. Battery check bars
10. Depth-of-field AE
11. Bulb exposure
12. Custom function control number
13. ISO indicator
14. AF mode
15. One-shot AF
16. AI servo AF
17. Manual focusing
18. Film winding mode
19. Single exposure
20. Continuous exposure (C_L, C_H: with the Power Drive Booster E1)
21. Self-timer
22. Exposure compensation value index
23. Film transport (wind/rewind)
24. Film wind completion
25. Battery check
26. Exposure compensation value indicator
27. Bulb exposure time
28. Auto exposure bracketing value
29. Frame counter
30. Bulb exposure time
31. Number of multiple exposure
32. Self-timer countdown
33. Multiple exposures
34. Auto exposure bracketing
35. Film-load check
36. Film rewind completion
37. Evaluative metering
38. Partial metering
39. Spot metering
40. Metering mode
41. Aperture value

Program Line Characteristics

Black: Based on usage with EF 50 mm f/1.8

Blue: Based on usage with the EF 35-105 mm f/3.5-4.5

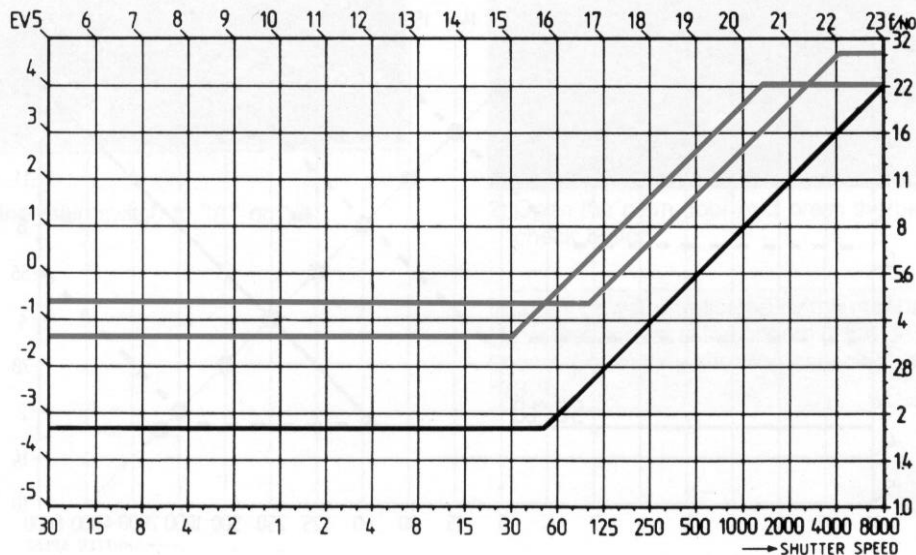

71

Example with shift at EV 13, using the EF 50 mm f/1.8

• indicates shutter speed/aperture combinations with program shift function.

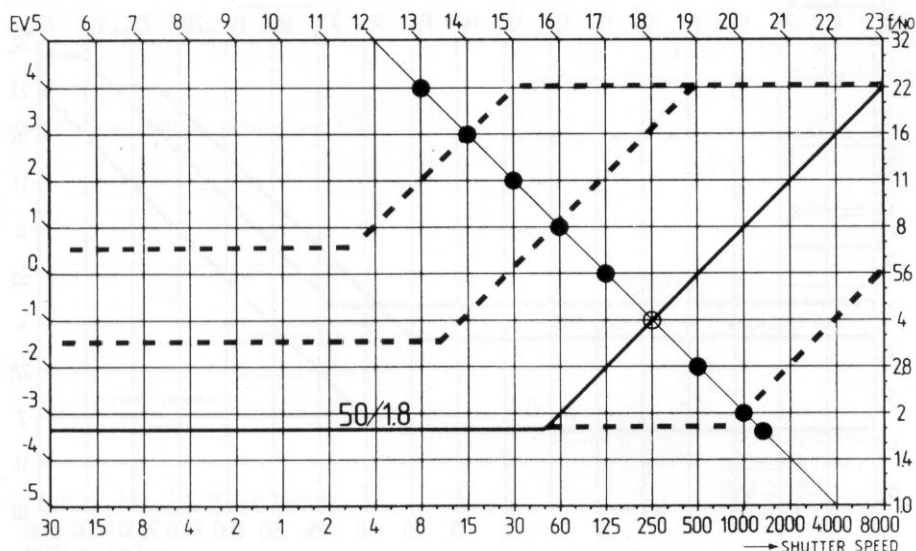

Battery Information

Battery Shooting Capacity

Based on a new 2CR5 lithium battery using the EF 50 mm f/1.8 and 24-exp. film.

Temperature	Capacity
Normal (20°C/68°F)	75 rolls
Low (-20°C/-4°F)	12 rolls
Test condition	Battery is checked after each roll is shot and rewind.
Test interval	20 seconds at normal temperature and 3 minutes at low temperature.

Test method: Shutter is released just after the 6-second metering timer function stops after autofocus, followed by 2-second timer function.

Normal temperature:
Repetition of 36 continuous exposures

Low temperature:
Repetition of 5 continuous exposures at 20 sec. intervals

Comparisons between AF Mode and Film Winding Mode (in evaluative metering)

AF mode Film winding mode	ONE SHOT AF	AI SERVO AF
S: single	AF lock and AE lock take place simultaneously when AF completes.	AF follows a subject and the exposure is determined at the moment of shutter release.
C: continuous	AF lock and AE lock take place simultaneously when AF completes, then continuous exposure is made.	AF follows a subject and the exposure is determined at the moment of shutter release. AF is adjusted to follow the subject during exposure.

W. Specifications

General

Type: 35 mm focal plane shutter SLR (Single-Lens Reflex) camera with autofocus, auto exposure and built-in motor drive

Lens Mount: Canon EF Mount (electronic signal transfer system)

Usable Lenses: Canon EF lenses

Viewfinder: Fixed eye-level pentaprism. Gives approx. 100% vertical and horizontal coverage of actual picture area and 0.72X magnification with 50 mm lens at infinity.

Focusing Screen: Laser-matte screen with AF frame. Six optional interchangeable screens are available.

Dioptric Adjustment: Adjustable (-3 dpt- +1 dpt) by turning knob

Eyepoint: 20 mm

Shutter: Vertical-travel metal focal plane shutter; all speeds electronically controlled.

Shutter Speed: 1/8000-30 sec. and bulb. X-sync is 1/250 sec. Can be set in 1/3-step increments.

Mirror: Quick return half-mirror

Autofocus

AF Control System: TTL-CT-SIR (Cross Type-Secondary Image Resistration) phase detection. Two modes available: One-shot and AI Servo AF with Focus Prediction. Manual focusing possible.

AF Working Range: EV -1-18 at ISO 100

AF Auxiliary Light: Specified Canon Speedlites automatically project light through an ultra-bright LED (peak sensitivity: 700 nm) when required.

Exposure Control

Light Metering: TTL full aperture metering using SPC (Silicon Photocell). Four metering patterns available:

1. Evaluative metering
2. Partial metering (approx. 5.8% of the picture area)
3. Spot metering (approx. 2.3% of the picture area)
4. Center-weighted average metering (with Custom Function #8)

Metering Range: Evaluative/partial metering: EV 0-20 with f/1.4 lens at ISO 100 or equivalent

Spot metering: EV 2-20 at ISO 100

Exposure Modes:

1. Shutter-Priority AE
2. Aperture-Priority AE
3. Depth-of-Field AE
4. Intelligent Program AE with Variable Shift Function
5. Manual
6. Flash AE (A-TTL and TTL program flash AE with specified Canon Speedlites)

Exposure Compensation: ± 3 steps in 1/3-step increments

Auto Exposure Bracketing: ± 3 steps in 1/3-step increments. Three continuous exposures are taken in sequence: one under, one at the standard metered value and one over.

Depth-of-Field Preview: With Depth-of-Field check button

Film Transport

Film Speed Setting: ISO 25-5000; automatically set in 1/3-step increments according to DX code. ISO 6-6400 can also be set manually.

Film Loading: Automatic

Film Wind: Automatic. Two modes available: S (Single Frame) and C (Continuous at up to 3 frames per second)

Film Rewind: Automatic (approx. 8 sec. with 24-exp. film). Mid-roll rewind possible.

Power Source

Battery: One, six-volt lithium battery pack (2CR5). Replaced by removing grip.

Battery Check: By pressing the battery check button. Three energy levels are shown by the bar marks in the display panel.

Shooting Capacity: (with 24-exp. film)
Normal (68°F/20°C): 75 rolls
Low (-4°F/-20°C): 12 rolls

Battery for memory backup: One CR1220. Battery life: Approx. 5 years, replaced at owner's expense at an authorized Canon service facility.

Notice**Other**

Custom Function Control: Eight functions selectable

Flash Contact: Direct contact at accessory shoe and PC terminal (JIS-B)

Remote Control Socket: Provided

Data Display: In the viewfinder and LCD display panel

Multiple Exposures: Up to nine exposures can be preset.

Self-Timer: Electronically controlled with a 2 or 10-sec. delay

Dimensions

Size: 6-5/16" (W) x 4-3/16" (H) x 2-13/16" (D)
(161 x 106.6 x 71.8 mm)

Weight: 1.9 lb. (850 g) without battery
2 lb. (890 g) with battery

All data are based on Canon's Standard Test Method.

Subject to change without notice.

This equipment has been tested and found to comply with the limits for a Class B computing device in accordance with the specifications set forth in Subpart J of Part 15 of the FCC Rules. If this equipment does cause interference to radio or television reception which can be determined by turning the equipment on and off, use the equipment in another location. If necessary, the user should consult the dealer or an experienced radio/television technician for additional suggestions. The user may find the following booklet prepared by the Federal Communications Commission helpful:

"INTERFERENCE HANDBOOK"

This booklet is available from the U.S. Government Printing Office, Washington, D.C., 20402, Stock No. 044-000-00450-7.

This digital apparatus does not exceed the Class B limits for radio noise emissions from digital apparatus set out in the Radio Interference Regulations of the Canadian Department of Communications.

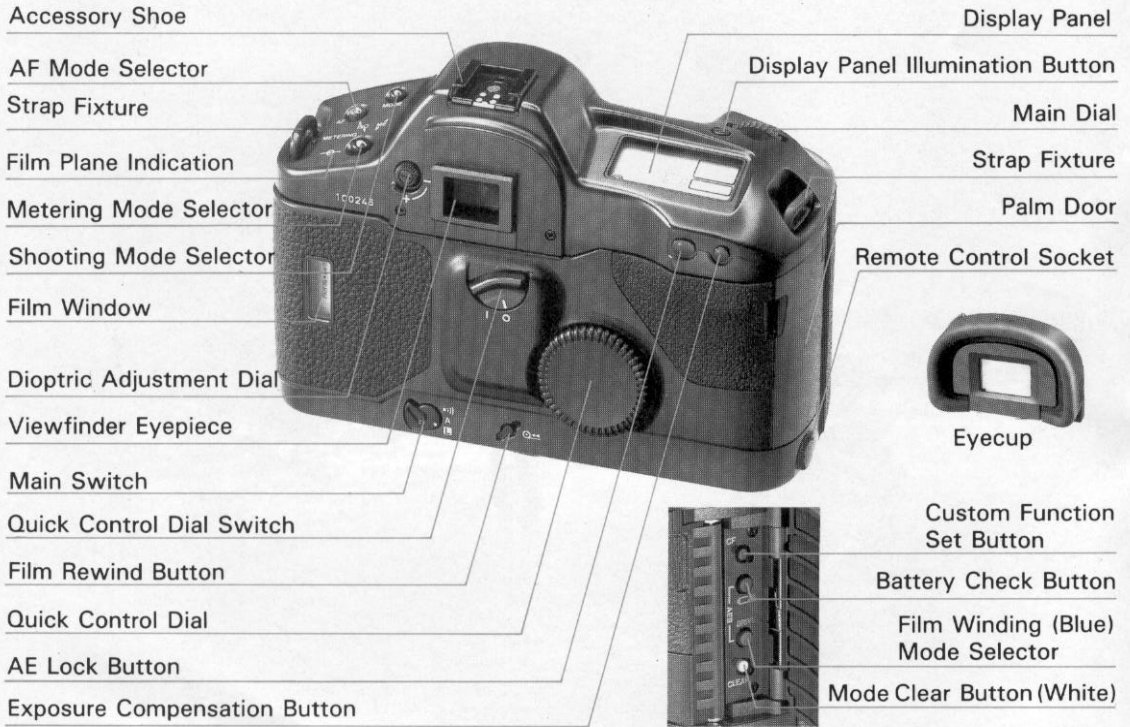

Canon

CANON INC. 7-1, Nishi-Shinjuku 2-Chome, Shinjuku-ku, Tokyo 163, Japan
Mailing address: P.O. Box 5050, Dai-ichi Seimei Building, Tokyo 163, Japan

- U.S.A.** _____ **CANON U.S.A., INC. HEADQUARTERS**
One Canon Plaza, Lake Success, N.Y. 11042, U.S.A.
CANON U.S.A., INC. ATLANTA OFFICE
5625 Oakbrook Parkway Norcross, Ga. 30093, U.S.A.
CANON U.S.A., INC. CHICAGO OFFICE
100 Park Blvd. Itasca, Il. 60143-2693, U.S.A.
CANON U.S.A., INC. LOS ANGELES OFFICE
123 Paularino Avenue East, Costa Mesa, Cal. 92626, U.S.A.
CANON U.S.A., INC. SANTA CLARA BRANCH
4000 Burton Drive, Santa Clara, Cal. 95054, U.S.A.
CANON U.S.A., INC. DALLAS OFFICE
3200, Regent Blvd., Irving, Tex. 75063-3145, U.S.A.
CANON U.S.A., INC. HONOLULU BRANCH
Bldg. B-2, 1050 Ala Moana Blvd., Honolulu, Hawaii 96814, U.S.A.
CANON U.S.A., INC. WASHINGTON D.C. BRANCH
5701 General Washington Drive Alexandria, Va. 22312, U.S.A.
- CANADA** _____ **CANON CANADA INC. HEADQUARTERS**
6390 Dixie Road, Mississauga, Ontario L5T 1P7, Canada
CANON CANADA INC. MONTREAL SERVICE CENTRE
10652 Côte de Liesse, Lachine, Quebec H8T 1A5, Canada
CANON CANADA INC. CALGARY OFFICE
2828, 18th Street, N.E. Calgary, Alberta T2E 7K7, Canada
- EUROPE, AFRICA & MIDDLE EAST** _____ **CANON EUROPA N.V.**
Bovenkerkerweg 59-61, P.O. Box 2262, 1180 EG Amstelveen, The Netherlands
CANON PHOTO VIDEO FRANCE S.A.
30, boulevard Vital-Bouhot, Ile de la Jatte, 92521 Neuilly-sur-Seine, France
CANON UK LTD.
Units 4 & 5, Brent Trading Centre, North Circular Road, London NW10 0JF, United Kingdom
CANON EURO-PHOTO G.m.b.H
Siemensring 90-92, D-4156 Willich 1, West Germany
- CENTRAL & SOUTH AMERICA** _____ **CANON LATIN AMERICA, INC. DEPTO. DE VENTAS**
Apartado 7022, Panamá 5, República de Panamá
CANON LATIN AMERICA, INC. CENTRO DE SERVICIO Y REPARACION
Apartado 2019, Zona Libre de Colón, República de Panamá
- SOUTHEAST ASIA** _____ **CANON HONG KONG TRADING CO., LTD.**
Room 1101-3 & 1121-2, Peninsula Centre, 67 Mody Road, Tsimshatsui East, Kowloon, Hong Kong
CANON SINGAPORE PTE. LTD
95 South Bridge Road # 13-01/15, South Bridge Centre, Singapore 0105
- OCEANIA** _____ **CANON AUSTRALIA PTY. LTD.**
Unit 1/37, Waterloo Road, North Ryde (Macquarie Park), N.S.W. 2113, Australia
- JAPAN** _____ **CANON SALES CO., INC.**
11-28, Mita, 3-Chome, Minato-ku, Tokyo 108, Japan

PUB. C-IE-146B
0989N7.5

©CANON INC. 1989
CY8-6105-002

PRINTED IN JAPAN