

USER MANUAL

for A6D Aerial

Version 1.5



HASSELBLAD
CREATE TO INSPIRE

Medium format photography is about professionalism. Camera systems, their handling and captures have to be professional in quality.

Hasselblad understands this and always strives to deliver it; professionals know that too. The Hasselblad series of cameras consists of building new developments on the shoulders of the previous generation. In this way all the previous work-experience based and segment-demanding features are automatically included. So, just when you think things can't get much better, they do. And the A6D is that model - all the good things from before and then some!

The A6D heralds a step up that is noticeably greater than before. There are changes and many are 'from the ground up'. The A6D provides a reliable connection to the fleeting environment of digital imaging technology so when the wind changes direction, the A6D remains as the safeguarding companion to provide support.

Today's aerial photography is more demanding than ever and Hasselblad continues to rise to the occasion, introducing more and more advanced products and applications for this exciting segment. This is especially true of the Hasselblad A6D, the latest evolution of Hasselblad aerial cameras designed for these specialist applications.

The new camera has been developed to deliver the image quality and reliability required by our surveying and mapping customers. Listening to their feedback we have developed a camera to encompass these needs and much more.

Hasselblad's best kept secret is knowing that every link in the chain that leads to the clients finished image has to reach a certain standard; it is that simple. That's why Hasselblad puts so much time and energy into checking those almost endless behind-the-scenes details and standards because we understand this simple concept.

There is no magical formula to Hasselblad's success other than an understanding of what is required to produce the best results available in the world today, and an acceptance that there are no short cuts in this process. Hasselblad does its best to produce the best; there is no other way to achieve the Hasselblad star quality.

The A6D has been designed to incorporate the latest technology available. The heart of the system is the 53.4 x 40.0 mm 100MP CMOS sensor delivering up to a staggering 15stops dynamic range and 16bit colour data. The system boasts an ISO range from 64 to 12800 and coupled with the top shutter speed of 1/4000th second allows the A6D huge flexibility to adapt to changing conditions whilst still delivering the image quality required.

Designed from the outset to be used in flexible configurations the A6D can be used as a stand alone single capture device or in grouped configurations for pod based survey needs. Up to 8 cameras can be triggered within 50 microseconds of each other to allow accurate image alignment with minimal overlap required. Note that only Aerial Lenses (locked for infinity) can be synchronized.



Completing the impressive specification, media storage is to CFast 2.0 or SDXC cards. Tethered capture is available via the USB 3.0 Type C port. To complete the family, the A6D is also available in NIR version, allowing both NIR and CIR photography.

FIRMWARE UPDATES

If you have registered your camera you should automatically receive e-mail informing you of the latest developments. Otherwise you are advised to make regular checks regarding firmware updates to the camera.

The aim is to ensure you have the latest firmware updates for camera, which naturally ensures the optimum in performance. When updating you should also study the accompanying 'Release Notes' or 'Read Me' files where you will find details about improvements, developments and changes.

DISPOSAL



This product must be put in municipal waste. Check local regulations for disposal.

Register your camera for regular news about the latest developments, updates, news, tips, and much else!

– www.hasselblad.com –

RESTRICTIONS AND RECOMMENDATIONS

Caution!

Be careful when you use the camera. The camera is a precision instrument. This will help prevent damage to the camera.

Caution!

Use protective covers as much as possible. The protective covers will help prevent damage to the equipment.

Caution!

Use a protective case or camera bag when you transport the equipment. This will help prevent damage to the equipment.

Caution!

Protect the equipment from oil fumes, steam, humid conditions and dust. This will help prevent damage to the equipment.

Caution!

Seal all equipment in a plastic bag or similar if you enter damp and humid condition from dry and cold condition. Wait until the equipment has acclimatized to the new temperature before you remove the equipment from bag. This will help prevent damage to the equipment.

Caution!

Avoid frequent and high temperature changes. This can cause damage to the equipment.

Caution!

Keep camera and equipment away from moisture. If your camera becomes wet, disconnect from electric power and let camera dry before further use. This will help prevent damage to the equipment.

Caution!

Store the equipment in a dry environment. This will help prevent damage to the equipment.

Caution!

Be careful when you attach/detach the components to/from the camera. This will help prevent damage to the data bus connections.

Caution!

Do not insert fingers into the camera body. This can cause damage to the equipment.

Caution!

Do not touch the CMOS Sensor with your fingers. The protective filter is very sensitive. This can cause damage to the equipment.

Caution!

Keep all equipment out of reach of small children. This will prevent damage to the equipment.

Caution!

Do not open the sensor unit. This can cause damage to the sensor unit.

Caution!

Do not try to remove the glass IR filter from the front of the CMOS (due to dust or similar). This can cause damage to the equipment. Always contact your local Hasselblad Authorized Service Centre.

Caution!

If you use canned compressed air to clean the glass of IR filter, be very carefully before use. This will help prevent damage to the filter.

CONTENTS

■ INTRODUCTION	2	General Settings Menu	24
Firmware Updates	4	Display Menu	24
Disposal	4	Storage Menu	25
Restrictions and Recommendations	5	Date & Time Menu	25
■ GENERAL OVERVIEW	7	Power & Timeouts Menu	26
Parts and Components – overview	8	Language Menu.....	26
A6D Lens Range.....	9	Service Menu.....	27
■ GETTING STARTED	10	About Menu	27
Mounting the lens	11	■ BROWSING IMAGES	28
Attaching the lens shield.....	11	Preview Modes.....	29
Attaching the adapter plate	12	Standard Preview	30
Power Connection.....	12	Browsing.....	31
Synchronous connections	12	Zoom in and out.....	32
USB & link to Phocus or SDK based application	12	9 View Mode.....	33
Saving images to a memory card	12	Folder View	33
Attaching the USB cable Lock.....	13	Card View	34
■ SETTINGS	14	Create New Folder	35
Navigating the Menus	15	■ CAMERA MAINTENANCE	36
Overview of Menus and Settings on Sensor Unit	15	Cleaning Sensor Unit & IR Glass.....	37
Touch Screen Navigation.....	15	■ TECHNICAL APPENDIX	38
Button Navigation.....	16	A6D-100c Technical Specifications	39
The Main Menu	17	Lemo connector Signal Information.....	40
Add Favourite Functions to Main Menu Screen	17	Electrical Timings	42
Remove Favourites from the Main Menu Screen.....	18	Coverage	44
Display Control Screen.....	18	Coverage vs altitude	44
Settings on the Control Screen.....	19	GSD vs altitude	44
Camera Settings Menu	20	Physical Dimensions	45
Image Menu.....	20	Accessories	49
Quality Menu.....	21	FCC Class A Notice for A6D-100c	50
Video Settings Menu	22	FCC Caution	50
Quality Menu.....	22	Disclaimer	50
Live View Menu	23	Index.....	51

PARTS AND COMPONENTS – OVERVIEW

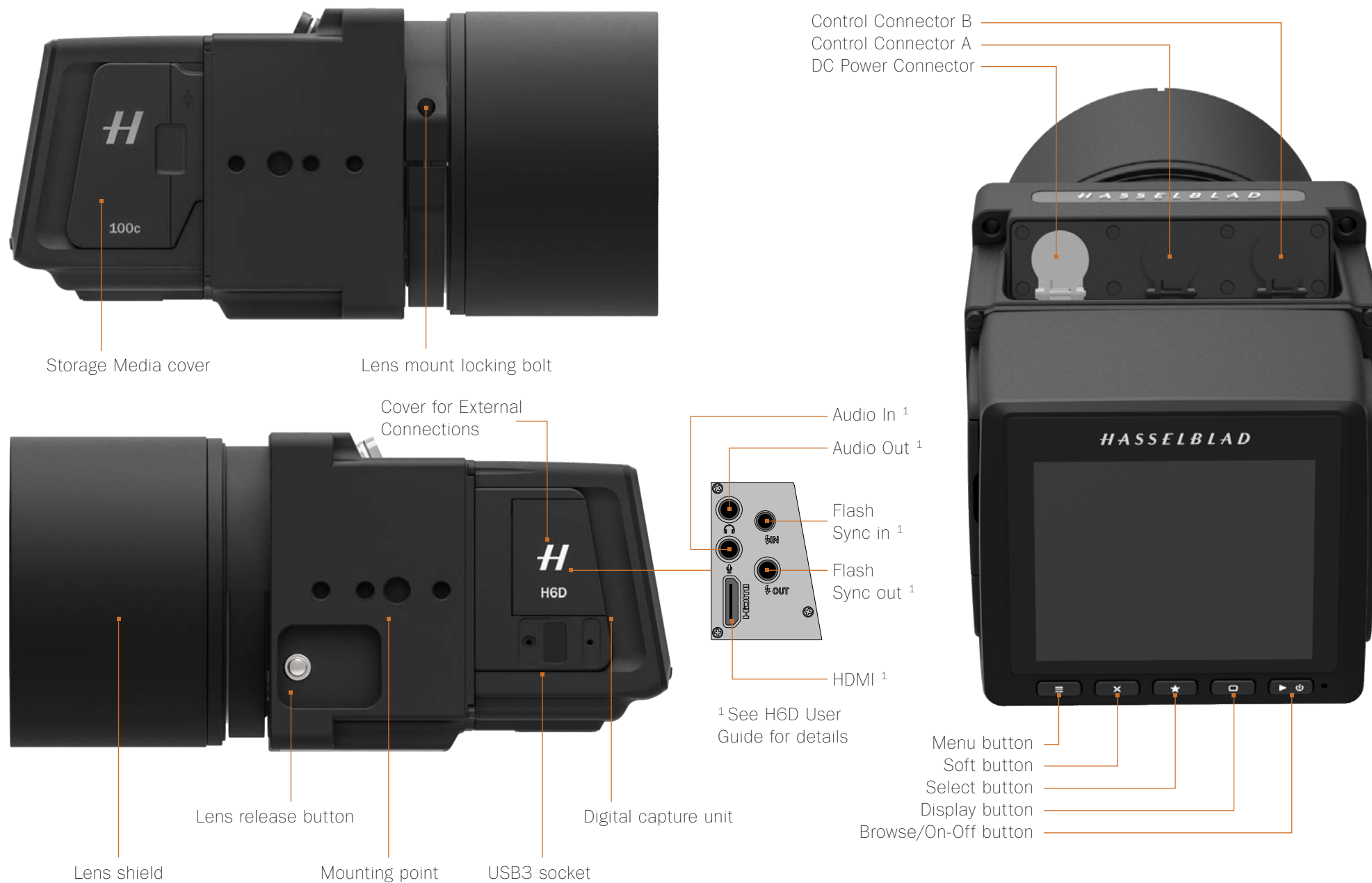

A6D LENS RANGE

All 9 focal lengths below are available in aerial versions with secure locking mounts to minimise vibration, flexing and ensuring the image plane and sensor stay parallel at all times. These units ship with focus fixed at infinity and firmware to close the shutter and aperture to their working positions when power is applied to the camera. The lenses are also available in a version for NIR photography.

Lenses	Angle of View (Diagonal)	Angle of View long side	Angle of View short side	Equivalent 35mm focal length	Dimensions Length x Diameter	Weight	Filter Thread	Item Number Focus Locked	Item Number Focus Locked, NIR	Item Number Focus disabled
HCD 4,8/24mm	104 Degrees	96 Degrees	80 Degrees	16mm	99mm x 100mm	810g	95mm	CPHB.00000003.01	CPHB.00000026.01	CPHB.00000322.01
HCD 4/28mm	95 Degrees	87 Degrees	71 Degrees	19mm	102mm x 100mm	850g	95mm	CPHB.00000004.01	CPHB.00000027.01	CPHB.00000319.01
HC 3,5/35mm	89 Degrees	75 Degrees	60 Degrees	24mm	124mm x 100mm	975g	95mm	CPHB.00000005.01	CPHB.00000028.01	CPHB.00000320.01
HC 3,5/50mm-II	70 Degrees	56 Degrees	44 Degrees	34mm	116mm x 85mm	975g	77mm	CPHB.00000006.01	CPHB.00000029.01	CPHB.00000321.01
HC 2,8/80mm	46 Degrees	37 Degrees	28 Degrees	55mm	70mm x 84mm	475g	67mm	CPTR00000053.01	CPHB.00000030.01	CPHB.00000315.01
HC 2,2/100mm	38 Degrees	30 Degrees	23 Degrees	67mm	80.5mm x 87.5mm	780g	77mm	CPHB.00000008.01	CPHB.00000031.01	CPHB.00000318.01
HC 3,2/150N mm	26 Degrees	20 Degrees	15 Degrees	101mm	124mm x 86mm	970g	77mm	CPHB.00000009.01	CPHB.00000032.01	CPHB.00000316.01
HC 4/210mm	19 Degrees	14 Degrees	11 Degrees	142mm	165mm x 85mm	1320g	77mm	CPHB.00000010.01	CPHB.00000033.01	CPHB.00000317.01
HC 4,5/300mm ¹⁾	13 Degrees	10 Degrees	8 Degrees	196mm	198mm x 100mm	2120g	95mm	CPHB.00000011.01	CPHB.00000034.01	CPHB.00000308.01

¹⁾ Note: The Tripod Mount bracket and Rotation Lock must be removed before attaching the HC300 lens to the camera.



GETTING STARTED

MOUNTING THE LENS

- 1 The A6D lens mount contains a locking mechanism that securely holds the lens in place with an even pressure all around the barrel.



Before mounting a lens ensure the plastic collar supplied with the lens is in position and the joint is aligned with the location lug.

- 2 To mount a lens, locate the red dot on the rear lens mount and ensure it is facing upwards. Insert the lens into the camera body and rotate clockwise until a click is heard.



To detach the lens, press the lens release button on the side of the camera and turn the lens anti-clockwise.

- 3 Locate the lens mount locking bolt.

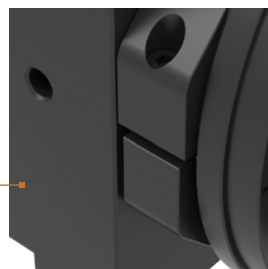

- 4 Insert the supplied 2.5mm Allen key into the bolt and rotate clockwise half a turn to engage the lens mount lock.



NB: Do not overtighten as damage to the lens mount may occur

ATTACHING THE LENS SHIELD

There are six lens shields available depending on the lens in use. To mount the shield for the lens, simply offer up the shield to the outer lens mount and rotate the shield clockwise until the shield locks.



To mount the shield for the 35mm lens it is first necessary to mount the adaptor ring to the existing outer lens mount. This adaptor ring is held in place with 4 screws.

Once this has been mounted, you can attach the lens and then mount the shield and secure it with a turn in the clockwise direction.



ATTACHING THE ADAPTER PLATE

- 1 To attach the A6D camera unit to an existing OEM camera mount point you will need the adapter plate (P1). This plate is attached to the camera body with 4 bolts. You must ensure that the plate is correctly oriented – please see the image below and align the plate correctly.



- 2 Secure the plate with the 4 supplied bolts, ensuring that you tighten them one turn at a time to provide even pressure. Once the plate is secure you can mount the lens. Attach the lens shield and the unit is now ready to mount in the camera pod using the existing P1 bolt layout.



POWER CONNECTION

The A6D camera unit is equipped with three LEMO connectors. The grey connector is the DC power connector. The unit requires a power source of 12-28 VDC to operate. This will normally be supplied via the aircraft power system.

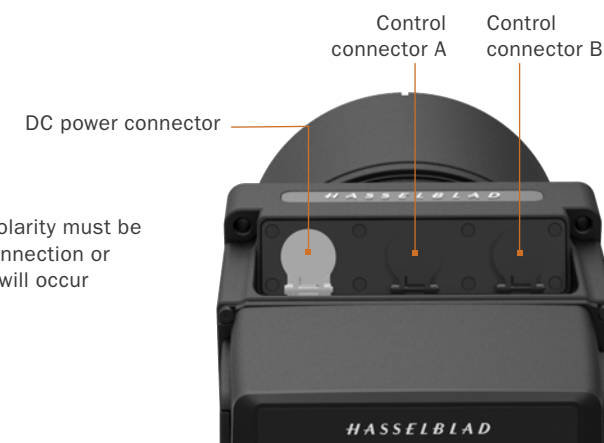

NB: Correct voltage **AND** polarity must be applied to the power connection or damage to the camera will occur

SYNCHRONOUS CONNECTIONS

The remaining two connectors are used to synchronise additional daisy chained camera units so that all exposures take place within 50 microseconds of each other. The centre connector is the signal input and the right hand connector is the signal output for the next unit. Note that this requires Aerial Lenses (locked for infinity).

USB & LINK TO PHOCUS OR SDK BASED APPLICATION

Located on the left-hand side of the camera you will find the USB socket. Using the supplied cable and the cable lock ensures the connection will be securely locked. Once the connector is locked in place and the other end of the cable attached to your computer system, the camera should show as connected and camera controls should be configurable via Hasselblad Phocus software or your own application designed from the SDK.

SAVING IMAGES TO A MEMORY CARD

If you do not wish to transfer the captured images to a remote computer, the CFast or SD card slots are available to allow in camera storage.

ATTACHING THE USB CABLE LOCK

- 1 Insert the cable through the lock part and insert the cable into to the USB port.



- 2 Attach the lock part and tighten the screws using the supplied 1.5mm Allen key. Note that it needs to be oriented correctly to fit.



NAVIGATING THE MENUS

OVERVIEW OF MENUS AND SETTINGS ON SENSOR UNIT

The Sensor Unit Menu can be controlled directly on the touch sensitive screen by pressing the menus and icons. You can scroll up, down and from left to right. You can also navigate the on screen menus by using the buttons and scroll wheels.

Note: Menu navigation is not possible when the camera is tethered and connected to Phocus.

TOUCH SCREEN NAVIGATION

The following gestures can be used to navigate and control the camera:

Action	Function
Swipe right	Move back / Move image right.
Swipe left	Move image left. Only in Browse mode.
Swipe down	Scroll / Display Control Screen.
Swipe up	Scroll / Hide Control Screen.
Tap / press	Select action / button / setting.
Double tap	Zoom in to 50% or 100%. Double tap again to Zoom out to full View.

Function	Action
Select	Tap / Press with one finger.
Display Control Screen	Swipe down from the top of the screen.
Hide Control Screen	Swipe up.
Move back	Swipe right.
Zoom in	Spread (move two fingers apart).
Zoom out	Pinch (move two fingers together).



Swipe right

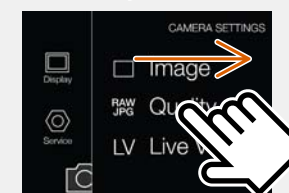

Swipe left



Swipe down



Swipe up

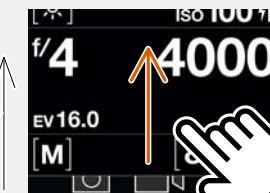

BUTTON NAVIGATION

By using the buttons on the sensor unit and the scroll wheels on the grip you can navigate through the various levels in the menu.

Button

- 1 Menu button
- 2 Soft button
- 3 Select button
- 4 Soft button
- 5 Browse/On-Off button

Screen function

- Back to Main Menu
- Up
- Select
- Down
- Go to image browse (short press)
- Turn camera On or Off (long press)



THE MAIN MENU

The Main Menu consists of two areas:

One bottom row with the three Main Menu items:

- 1 Camera Settings.
- 2 Video Settings.
- 3 General Settings.

The area to the right (4) shows the Favourite Settings Shortcuts. You can add Shortcuts to access your most used functions directly from the Main Menu for better workflow. Shortcuts can also be deleted and replaced by other Favourite Settings.

ADD FAVOURITE FUNCTIONS TO MAIN MENU SCREEN

Add a favourite function by selecting the + icon (A) on the Main Menu.

Select any of the function in the pop up menu (B). In this case Quality is selected.

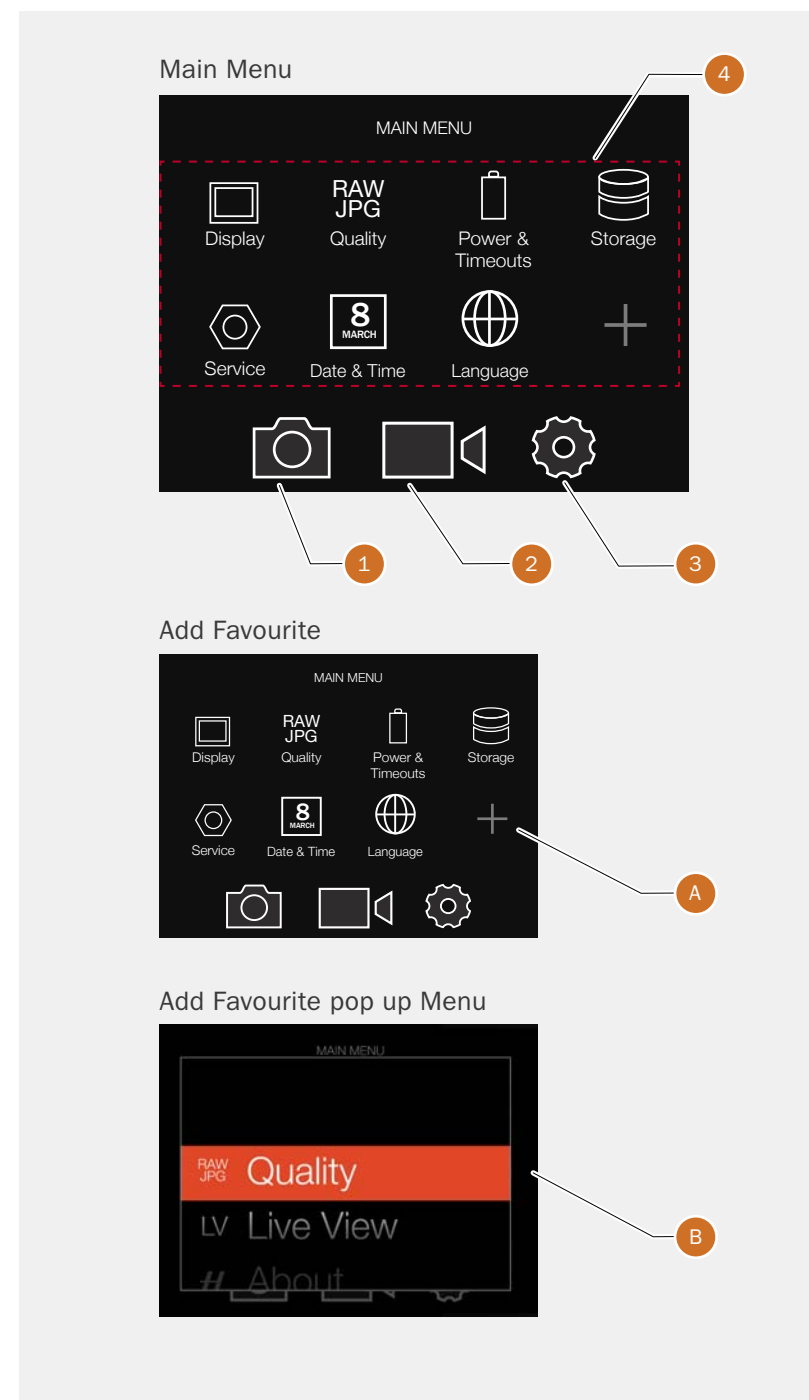

REMOVE FAVOURITES FROM THE MAIN MENU SCREEN

To remove a function from the Main Menu, press and hold the selected functions icon until an encircled x (A) appears.

Press the x within an orange circle (A) to remove the Language short-cut.

DISPLAY CONTROL SCREEN

From any screen you can swipe down to display the Control Screen. Swipe down by starting on the upper part of the Sensor Unit Display near the top edge.

The Control Screen displays the current Settings of the camera. The Control Screen is interactive, select any of the settings to make a quick adjustment.

Swipe Up to hide the Control Screen and display the Main Menu.

The Main Menu appears.

See following pages for possible settings.

Remove Favourite

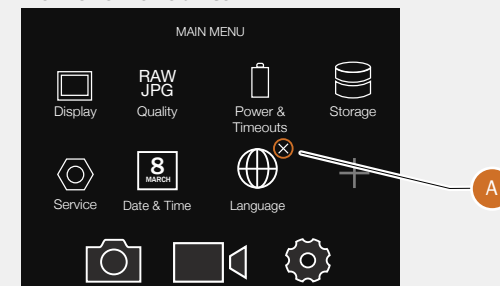

1 Swipe down



2 Control Screen

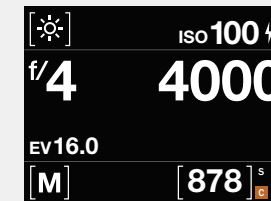

3 Swipe up

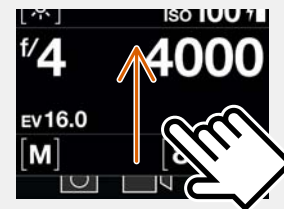

4 Main Menu

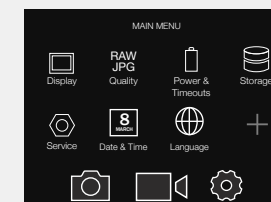

SETTINGS ON THE CONTROL SCREEN

The Control screen is a quick way to adjust settings. Tap / Select the desired function and change the setting directly in the Control Screen.

White Balance (1)

- Cloudy.
- Shade.
- Daylight.
- Tungsten.
- Fluorescent.
- Flash.
- Manual.

ISO (2)

- Select ISO value.

Aperture (3)

- Select Aperture value.

Shutter Speed (4)

- Select Shutter Speed value.

Exposure Mode (5)

- M Manual.
- V Video

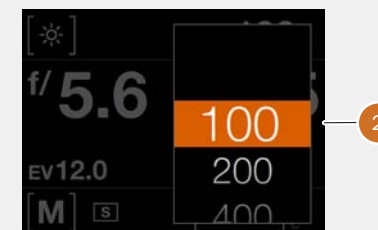

CAMERA SETTINGS MENU

Main Menu

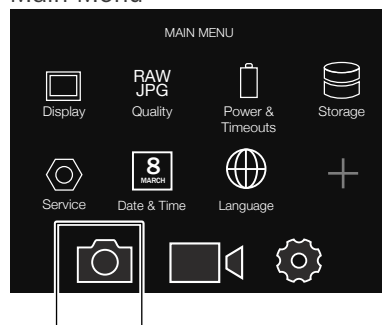

Camera icon

Camera Settings Menu

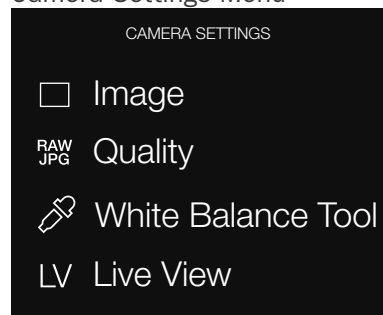
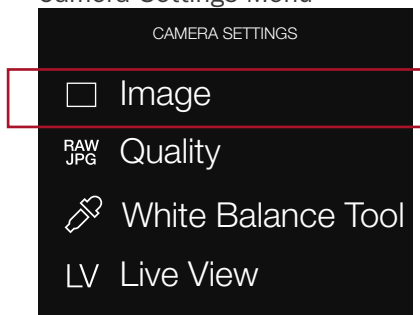

IMAGE MENU

Camera Settings Menu



MAIN MENU > CAMERA SETTINGS > IMAGE

Image Settings Menu

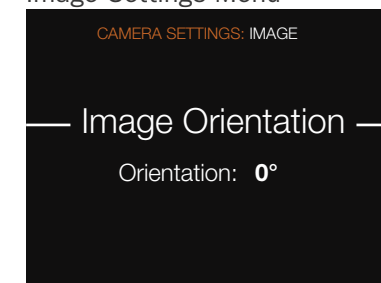

MAIN MENU > CAMERA SETTINGS

Press the Camera icon on the Sensor Unit display.

The Camera Settings Menu appears.

Swipe right or press MENU button to get back to Main Menu.

Image Orientation

Selects the rotation of the image. For Aerial use, it is best to choose one of the fixed rotations. Choose from:

- **0°, 90°, 180°, 270° or Auto**

QUALITY MENU

Camera Settings Menu

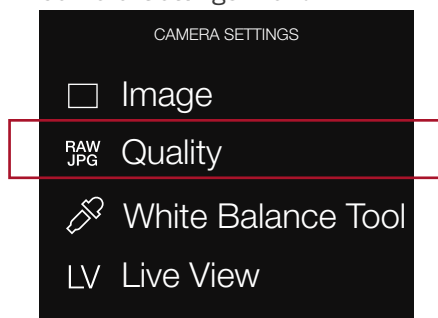

Quality Settings Menu

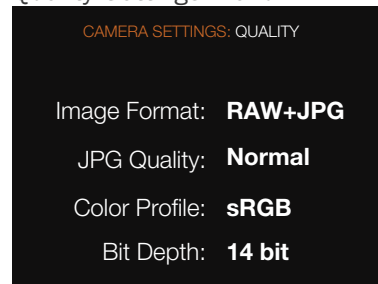

MAIN MENU > CAMERA SETTINGS > QUALITY

Image Format

Choose which image formats to save to card.

- **RAW** or **RAW + JPG**. In addition to the RAW file, also a 12.5 MPixel JPG is saved to the card

JPG Quality

If RAW + JPG is selected in the menu above, this option is available and controls the quality of the JPG file.

- **High** or **Normal**

Color Profile

If RAW + JPG is selected in the menu above, this option is available and selects which color profile to embed in the JPG.

- **sRGB** or **Adobe**

Bit Depth

Selects the bit depth of the RAW file.

- **16 bit** or **14 bit** (16 bit mode will lower the capture rate of the camera)

WHITE BALANCE TOOL

Camera Settings Menu

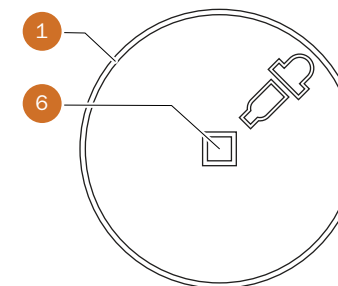
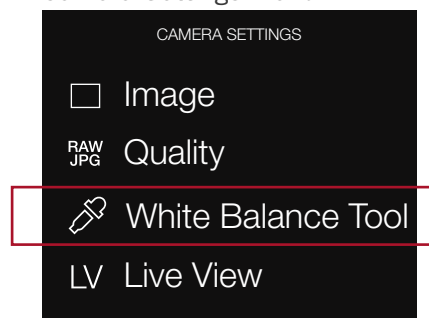

MAIN MENU > CAMERA SETTINGS > WHITE BALANCE TOOL

This function is used to set the colour temperature and tint for a scene where it is difficult to find a matching pre-set value.

- 1 Browse to the image you want to use for White Balance setting.
- 2 Select the White balance Tool from the Camera Settings menu.
- 3 Move the Color picker and place the small square over a neutral area.
- 4 Tap Set (**C**).

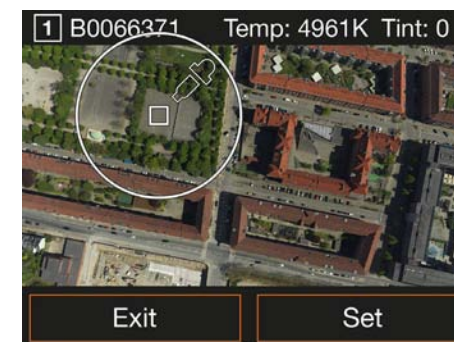

LIVE VIEW MENU

Camera Settings Menu

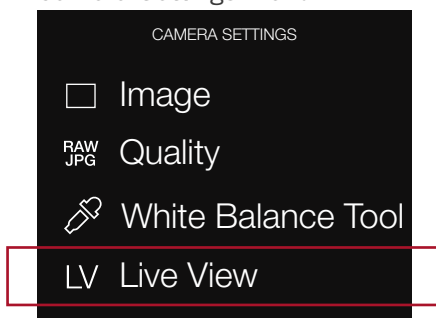

Live View Settings Menu

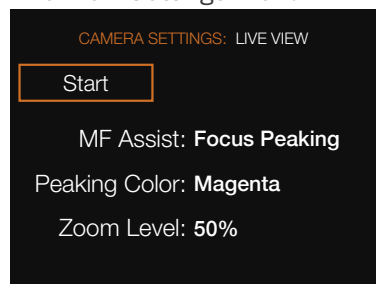

MAIN MENU > CAMERA SETTINGS > LIVE VIEW

Start

Press this button to start Live View

MF Assist

Select if Focus Peaking should be used in manual Focus.

- **Focus Peaking** or **None**

Peaking Color

Choose which color to use for Focus Peaking.

- **Orange, Yellow, Cyan** or **Magenta**

Zoom Level

Select Zoom-in level in live view.

- **100%** or **50%**

VIDEO SETTINGS MENU

Main Menu

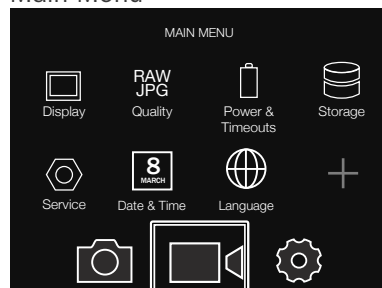

Video icon

Video Settings Menu

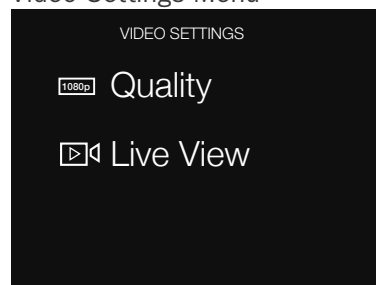

QUALITY MENU

Video Settings Menu

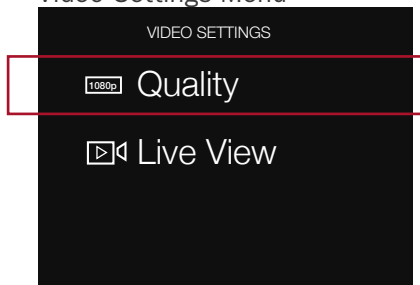

Video Quality Settings Menu

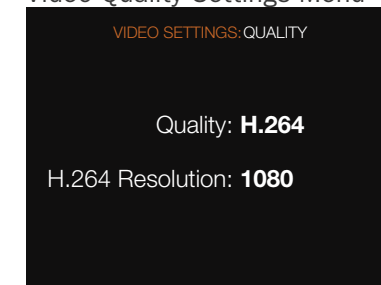

MAIN MENU > VIDEO SETTINGS

Press the Camera icon on the Sensor Unit display.

The Video Settings Menu appears.

Swipe right or press MENU button to get back to Main Menu.

MAIN MENU > VIDEO SETTINGS > QUALITY

Quality

Select quality for video recording.

- **H.264 (HD)** or **RAW (UHD)**. Note that RAW video requires a CFast storage media.

H.264 Resolution

Choose resolution for H.264 video.

- **720** or **1080**

LIVE VIEW MENU

Video Settings Menu

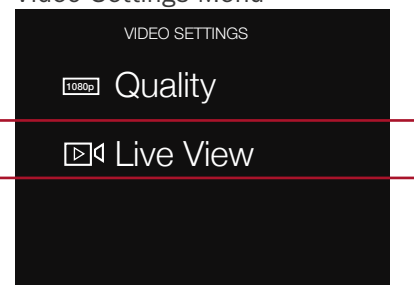

Video Live View Settings Menu

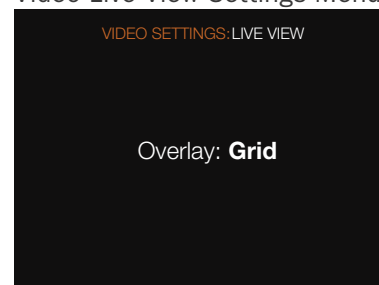

MAIN MENU > VIDEO SETTINGS > Live View

Overlay

Selects a one-thirds grid overlay.

- **Grid** or **None**.

GENERAL SETTINGS MENU

Main Menu

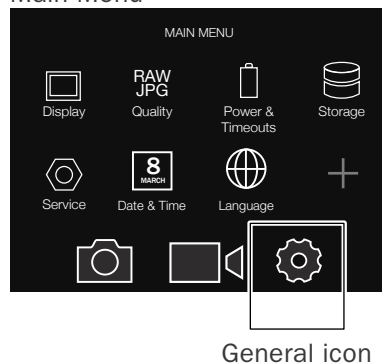

General Settings Menu

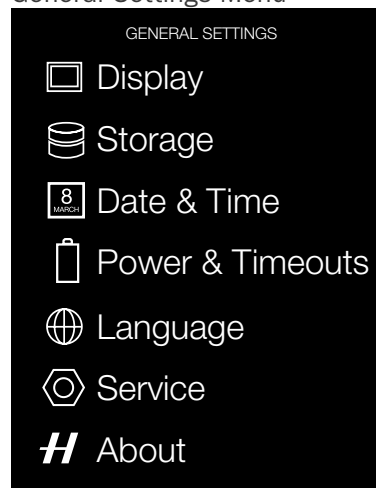

MAIN MENU > GENERAL SETTINGS

Press the Camera icon on the Sensor Unit display.

The General Settings Menu appears.

Swipe right or press MENU button to get back to Main Menu.

DISPLAY MENU

General Settings Menu

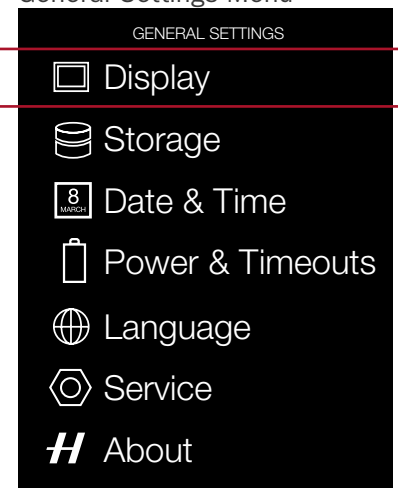

MAIN MENU > GENERAL SETTINGS > DISPLAY

Brightness

- Use slider to set brightness for the rear display.

Show Preview

- Check this box to show a preview on the rear display after a capture.

Display Settings Menu

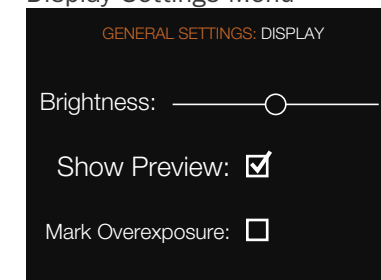

STORAGE MENU

General Settings Menu

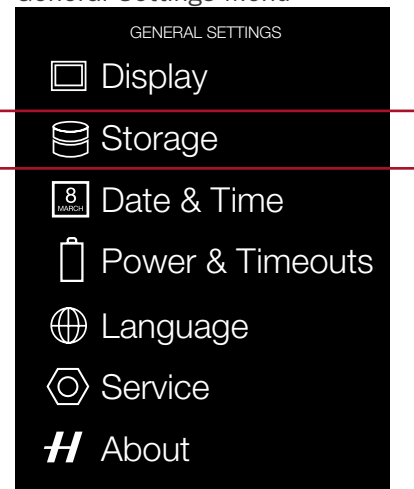

Storage Settings Menu

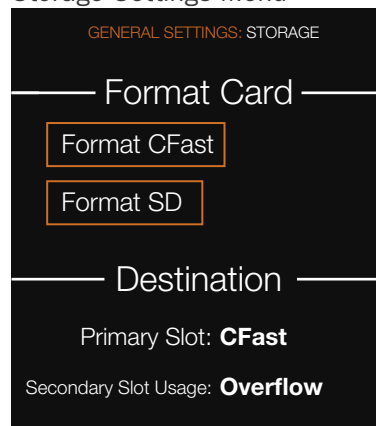

MAIN MENU > GENERAL SETTINGS > STORAGE

Format CFast

Format the CFast card.

Format SD

Format the SD card.

Primary Slot

Select which media that should be primary

Secondary Slot Usage

Selects how to use the secondary slot

- **None**
- **Overflow.** Continue on secondary card when primary card is full

DATE & TIME MENU

General Settings Menu

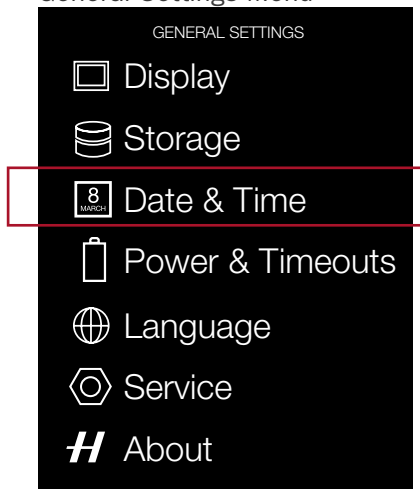

MAIN MENU > GENERAL SETTINGS > DATE & TIME

Date & Time Settings Menu

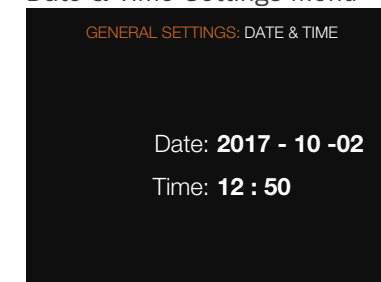

Date

Set the date by touching the numbers.

Time

Set the current time by touching the numbers.

POWER & TIMEOUTS MENU

General Settings Menu

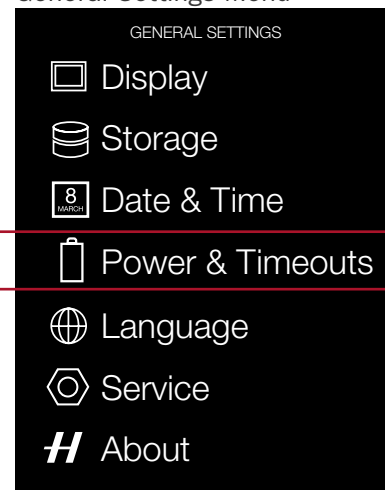

Power & Timeouts Settings Menu

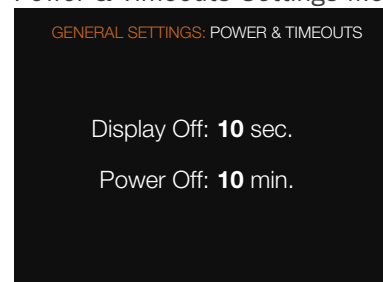

MAIN MENU > GENERAL SETTINGS > POWER & TIMEOUTS

Display Off

Sets the active time for the rear display.

- **3, 5, 10, 20, 30 or 60 seconds** or **Never**

Power Off

Sets the time after which the camera will turn off automatically. Please note that if the camera has turned off automatically, the power cable must be removed and re-inserted.

- **5, 10 or 30 minutes** or **Never**

LANGUAGE MENU

General Settings Menu

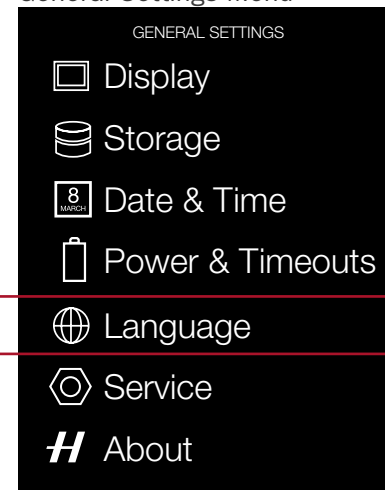

Language Settings Menu

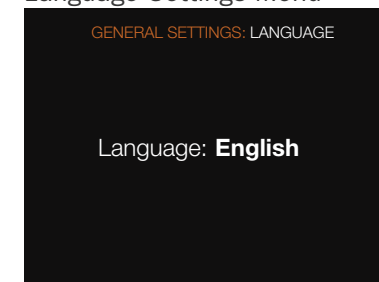

MAIN MENU > GENERAL SETTINGS > LANGUAGE

Language

Selects active language.

- **English, Spanish, French, German, Italian, Swedish, Russian, Japanese, Chinese and Korean**

SERVICE MENU

General Settings Menu

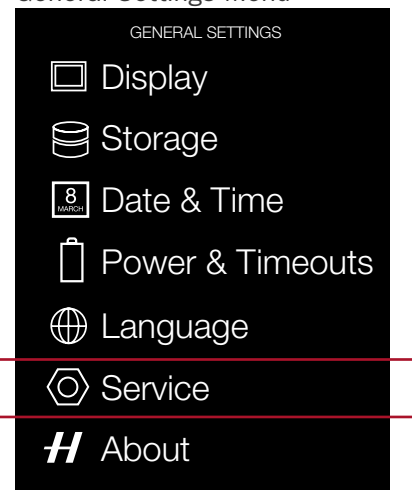

Service Settings Menu

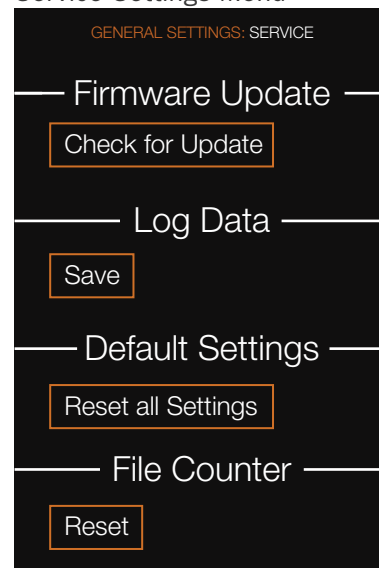

MAIN MENU > GENERAL SETTINGS > SERVICE

Check for Update

Press this button to locate an update file on any of the memory cards.

Log Data – Save

Save a log file to the primary memory card.

Reset all Settings

Return the camera to factory default. Note: all settings in the camera are reset.

File Counter – Reset

Reset the file counter to start from B0000001. **Note:** Please format the card before using this function.

ABOUT MENU

General Settings Menu

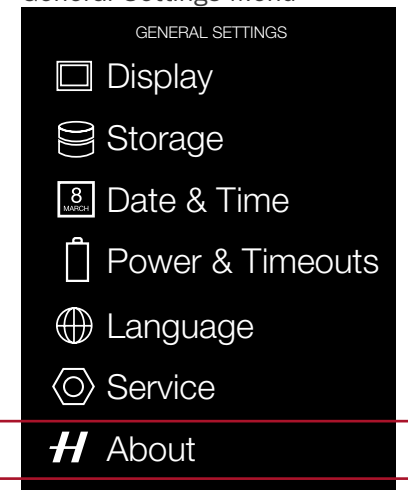

About Menu

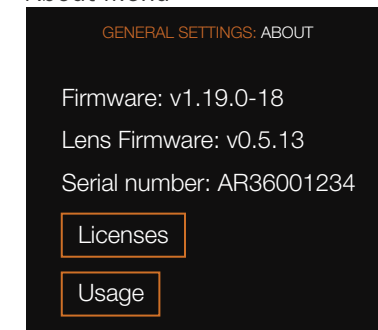

MAIN MENU > GENERAL SETTINGS > ABOUT

Shows firmware version for camera body and lens as well as camera serial number.

Licenses

Shows a list of licenses used in this product.

Usage

Shows the number of captures made by the camera body and lens.

PREVIEW, HISTOGRAM AND BROWSING

PREVIEW MODES

Use the Rear Scroll Wheel or the button marked with a rectangle to scroll through the available Preview Modes when in Browse Mode. You can also single tap on the bottom of the image to change Preview Mode.

- **Standard Preview:** Displays a Preview Image with the most important settings. Note that the information covers some of the image. Go to Full Screen mode to see the complete Capture area.
- **Full Screen Preview:** Displays the preview only with no frame or settings information.
- **Capture Details Mode:** Displays a Preview Image with camera settings details in a layer in front of the Preview Image.
- **Combined Histogram:** Displays a Preview Image with a combined histogram of the three components red, green and blue.
- **Separate Histogram:** Displays three separate histograms for red, green and blue.
- **Luminance Histogram:** Displays a Preview Image with a Luminance Histogram.

Note!

A single tap above the Meta Data toggles overlay information on and off.

Standard Preview



Full Screen Preview



Capture Details Mode



Combined Histogram

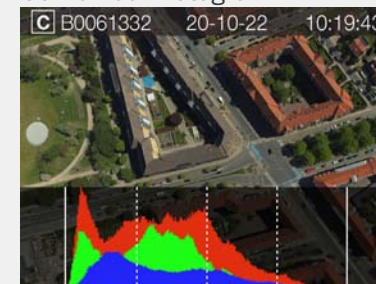

Separate Histogram

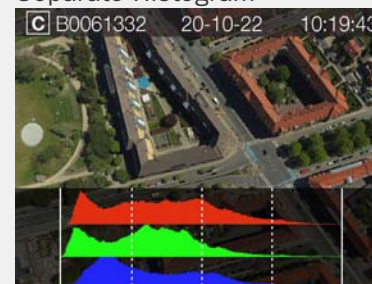

Luminance Histogram

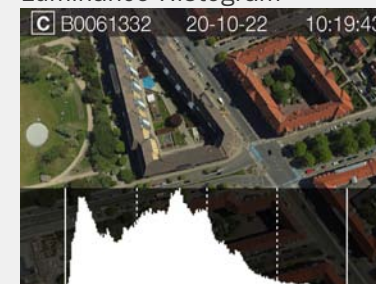

STANDARD PREVIEW

The Standard Preview is displayed when you first turn the camera on and is probably the view you will use most often.

Displays a preview of your most recent capture and basic information about the settings.



1 Card (S for SD)

2 Capture Date

3 Capture Time

4 Aperture (f4,5)

5 Shutter Speed
(2000)

6 ISO Setting (200)

7 +/- Exposure
Adjust Indicator

BROWSING

Browse mode shows the last image. The user can review images, browse and zoom. Use zoom in to view close-ups of images for focus checking. Zoom out to view several images at once.

Press Play button (A) to enter Browse mode.

In Browse mode swipe right or left on the Sensor Unit display to browse captures.

Captures can be deleted with the Soft Button (B).



ZOOM IN AND OUT

The Touch Screen on the A6D Sensor Unit is similar to a Phone or Tablet with touch sensitivity. The following gestures can be used to navigate and control the A6D Camera:

Function	Action
Zoom in	Spread (move two fingers apart).
Zoom out	Pinch (move two fingers together).
Select	Tap / Press with one finger.
Move back	Swipe right.
Display Control Screen	Swipe down from the top of the screen.
Hide Control Screen	Swipe up.
Action	Function
Double Tap	Zoom in to 100%. Double Tap again to Zoom out to full View.
Swipe Right	Move back / Move image right.
Swipe Left	Move image left. Only in Browse mode.
Swipe Down	Display Control Screen.
Swipe Up	Hide Control Screen.
Tap / Press	Select action / button / setting.

Standard Preview



Zoomed View

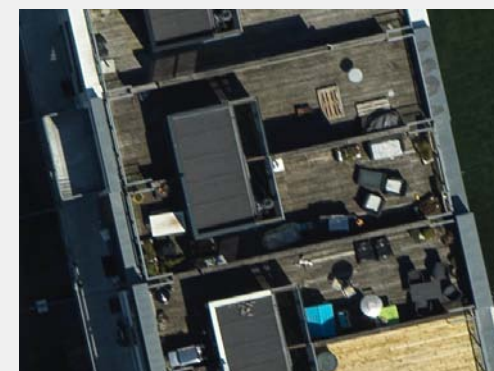

9 VIEW MODE

9 View Mode displays an overview of up to 9 captures. Scroll down to display all Captures in the Folder. Press the star marked button under the Touch Display or Pinch with two fingers, to display 9 View Mode when browsing captures.

FOLDER VIEW

On the Touch Display when in 9 View Mode, select the “Folder Up” button (A) in the top left corner to enter Folder View.

Folder View displays the list of folders on the memory card. Navigate to another folder and then zoom in to reveal its contents if desired.

9 View Mode

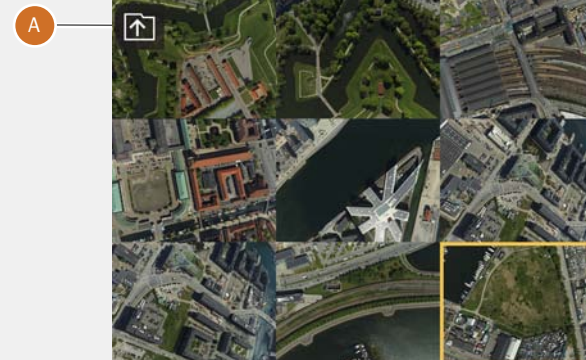

Folder View

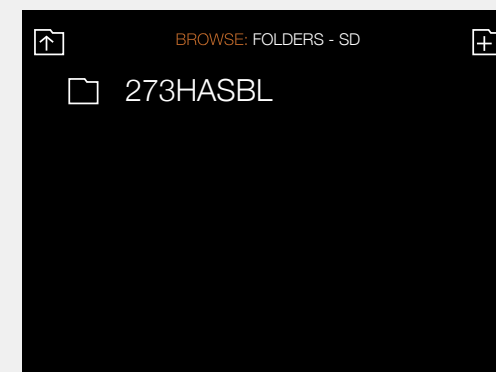

CARD VIEW

Card View (2) lets you select which memory card to browse.

On the Touch Display when in Folder View (1), select the “Folder Up” button (A) in the top left corner.

In Card View (2), tap the card you wish to browse. The folder view of the selected card will be shown (3). Tap the folder you wish to browse and the 9-view will be shown for that folder (4). Finally tap the image to show in Standard Preview (5).

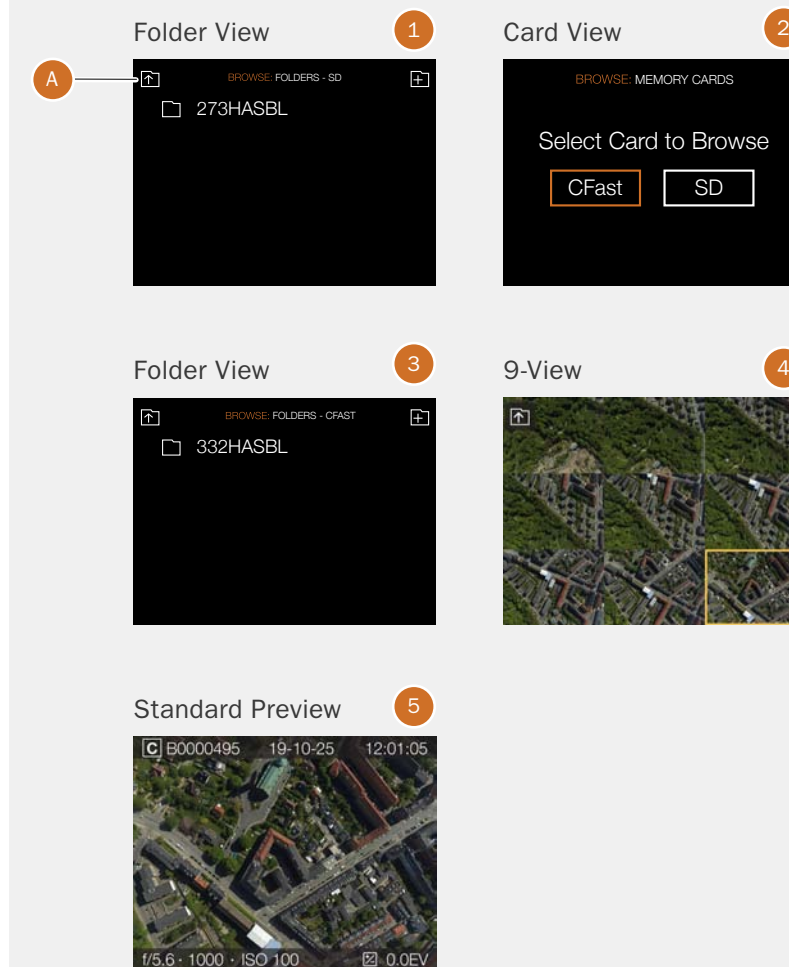

CREATE NEW FOLDER

It is possible to create a new folder on the currently active memory card. When a new folder is created, all new images will be stored in that folder. The folder name is auto-generated and cannot be changed.

It is not possible to store images in a previous folder.

When viewing one image, pinch inwards to go to the 9 images view.

In the 9 images view - Press the “Folder Up” button in the top left corner to go to folders.

In the folders view - Press the “Add folder” button (A) in the top right corner to create a new folder.

In the Create Folder dialogue (B), choose **Create** to create a new folder or **Exit** to skip.

Note!

It is only possible to create a new folder on the currently active card. When browsing the other card, the “Add Folder” icon will not be available.

Folder view

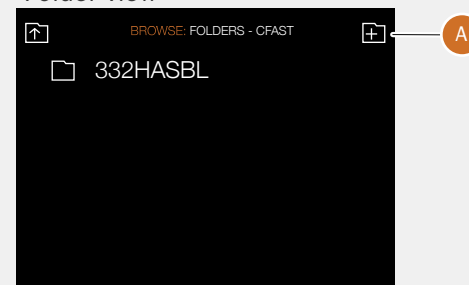

Create folder dialogue

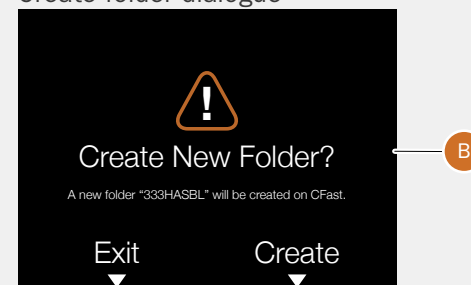

Folder view

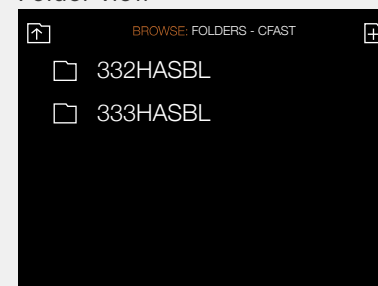

CAMERA MAINTENANCE

CLEANING SENSOR UNIT & IR GLASS

If you see dark or colored spots or lines in your images, then you may need to clean the outer surface of the sensor unit's infrared (IR) filter. In most cases, the careful use of compressed air will be adequate though if you use canned compressed air, read the instructions very carefully before use to avoid spraying impurities or even ice on the filter! Sometimes, however, small particles will get stuck to the surface of the IR filter, requiring for a more thorough cleaning, involving either fluid or swab wipes.

- 1 If compressed air did not remove all the problems on the filter, then use a long-handled swab style wipe (swab style wipes are recommended due to the distance from the lens mount to the sensor surface).
- 2 Ensure that the swab matches the width of the IR filter (if possible).
- 3 Apply firm pressure at the edge of the swab to ensure an even, firm contact with filter surface. Wipe the surface in one unbroken motion.
- 4 Finally check if the IR filter has been properly cleaned either by visual inspection by making a test capture. If further cleaning is needed, repeat cleaning procedure.



TECHNICAL APPENDIX

A6D-100C TECHNICAL SPECIFICATIONS

Sensor Type	CMOS, 100 mega pixels (11600 × 8700 pixels, 4.6 × 4.6 μm)
Sensor Dimensions	53.4 × 40.0mm
Image Size	Stills: RAW 3FR capture 211MB on average. TIFF 8 bit: 289MB; Video: HD (1920 x 1080p), UHD (3840 x 2160p)
File Format	Stills: Hasselblad 3FR, JPEG (12.5 MPixel) Video: Hasselblad RAW (UHD, 25 fps), H.264 Compressed (HD, 25 fps)
Shooting Mode	Single shot stills, Video
Colour Definition	16 bit. Dynamic range up to 15 stops
ISO Speed Range	ISO: 64, 100, 200, 400, 800, 1600, 3200, 6400, 12800
Colour Management	Hasselblad Natural Colour Solution, HNCS
Lenses	Any H System lens. Focus locked at infinity on request. See “A6D Lens Range” on page 9.
Focusing	Manual or Focus locked at infinity
Storage Options	CFast 2.0 card, SD card (UHS-I) or tethered to Mac or PC
Capture Rate (Based on SanDisk Extreme PRO CFAST 2.0 Memory Card)	60 Captures per minute.
Storage Capacity	128GB card holds 576 images on average
IR Filter	Mounted in front of sensor. NIR Option on request, CIR prepared.
Software	Phocus for Mac and Windows. Phocus SDK for Windows available on request.
Platform Support	Macintosh: macOS version 10.11 or later; PC: Windows 7 / 8 / 10 or later (64 bit)
Host Connection Type	USB 3.0 (5 Gbit/s) Type-C connector
Additional Connections	LEMO type connectors for power and camera control. Mini HDMI, Audio In/Out, Flash sync In/Out
Tethered Operation	Supported in Phocus and Phocus SDK
Shutter Speed Range	0.5 sec to 1/4000 sec (only with Aerial Lenses)
Exposure Metering	None
Power Supply	12-28 VDC required via LEMO connector
Operating Temperature	-10 - 45 °C / 14 - 113 °F
Dimensions	100 x 100 x 151mm [W x H x D] Complete camera with HC80mm lens
Weight (Body and sensor unit only)	1360g
Approval	FCC (Class A), CE, RoHS, DO-160 section 8 - 15 - 20 and 21

LEMO CONNECTOR SIGNAL INFORMATION

POWER CONNECTOR

Voltage Limit

Characteristics	Symbol	Value	Unit (DC)
Maximum input voltage	VSOH	28	V
Minimum input voltage	VSOH	12	V

CURRENT LIMIT

The Power + signal will conform to the following current requirements:

Characteristics	Symbol	Value	Unit (DC)
Typically average current consumption for Power +	ICCA	1000	mA
Typically peak current consumption for Power +	ICCP	2500	mA
Typically peak power consumption for Power +	ICCP	25	Watt

It is recommended to use a Class II double insulated power supply, or a power limited external battery. The source should always be limited to a output power of no more than 100 watts in total.

CONNECT OR PIN NO.

Signal Name	Power cable wire colour	Signal description
1 GND	White	Power GND (-)
2 VCC	Brown	Main power (+)

MALE PLUG PIN-OUT

The below illustration shows the connectors pin-out seen from the solder side of the male plug.

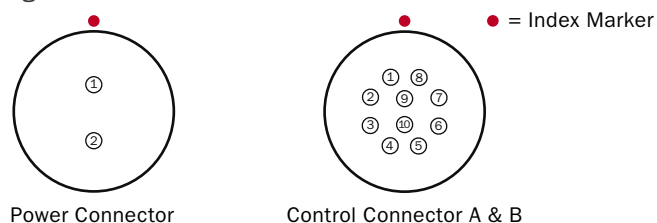

CONTROL CONNECTOR A & B

The below table shows the connectors pin numbers, signal names and signal direction in the control connector.

Connect or pin no.	Control cable	Signal name	Signal description	Direction	Type
1	White	CL	Reserved for future use	InOut	I/O
2	Brown	CH	Reserved for future use	InOut	I/O
3	Green	Vsys -	0 VDC Logic Supply	-	POWER
4	Yellow	Vsys +	+ 5 VDC Logic Supply	-	POWER
5	Grey	RX	Serial channel, RX signal	Input	CMOS
6	Pink	TRIG	Trig Camera	Input	CMOS
7	Blue	- BUSY	Camera Busy	Output	OC
8	Red	INTERNAL	Reserved	InOut	-
9	Black	- EXPOSE	Shutter Open	Output	OC
10	Purple	TX	Serial channel, TX signal	Output	CMOS
Shield	GROUND	GROUND	Chassis ground	Camera↔External flash	-

SYSTEM LOGIC SUPPLY SIGNALS

The VSYS+ power is always supplied to the control connector from the Camera housing.

SYSTEM STARTUP

During system startup (when the main power is applied into the Camera housing) the following requirements will apply for the System Logic supply signal +VSYS:

Characteristics	Symbol	Value	Unit (AC)
Maximum +VSYS voltage rise time	TRVS	40	ms

The total capacitive load between +VSYS and -VSYS should not exceed the following limit:

Characteristics	Symbol	Value	Unit
Maximum capacitive load on VSYS	CLVS	150	µf

VOLTAGE LIMIT

The VSYS+ signal will conform to the following voltage requirements:

Characteristics	Symbol	Value	Unit (AC)
Maximum output voltage	VSOH	5.25	V
Minimum output voltage	VSOL	4.75	V

CURRENT LIMIT

The VSYS+ signal will conform to the following current requirements:

Characteristics	Symbol	Value	Unit (AC)
Peak current consumption for VSYS+	ICC	40	mA

VOLTAGE LIMIT

The electrical definition of signal type “CMOS” will be according to the limits specified below:

Characteristics	Symbol	Value	Unit (DC)
H level output voltage (min)	VOH	4.0	V
L level output voltage (max @ IOL)	VOL	0.4	V
L level output current	IOL	4.0	mA
H level input voltage (min)	VIH	3.5	V
L level input voltage (max)	VIH	1.5	V

The electrical definition of signal type “OC” will be according to the limits specified below:

Characteristics	Symbol	Value	Unit (DC)
H level output voltage (max)	VOH	VSYS +	V
Pull-up impedance	R	10	Kohm
L level output voltage (max @ IOL)	VOL	0.4	V
L level output current	IOL	20.0	mA

TRIG, -EXP and -BUSY timing relationship

Characteristics	Symbol	Value	Unit (AC)
Rise time (max)	tR	1.0	µs
Fall time (max)	tF	1.0	µs
TRIG pulse width (min)	tTRIG	10	ms
Expose start (min)	tSTART	100	µs
Expose start (max)	tSTART	1	ms
BUSY start (min)	tBUSY	0	ms
BUSY start (max)	tBUSY	200	ms
ACTIVE time (min)	tACT	1000	ms
ACTIVE time (max)	tACT	∞	s
Mid expose pulse width (typ)	tMID	5	ms

ELECTRICAL TIMINGS

The electrical timing when using **EXPOSE** signal as mid exposure indicator:

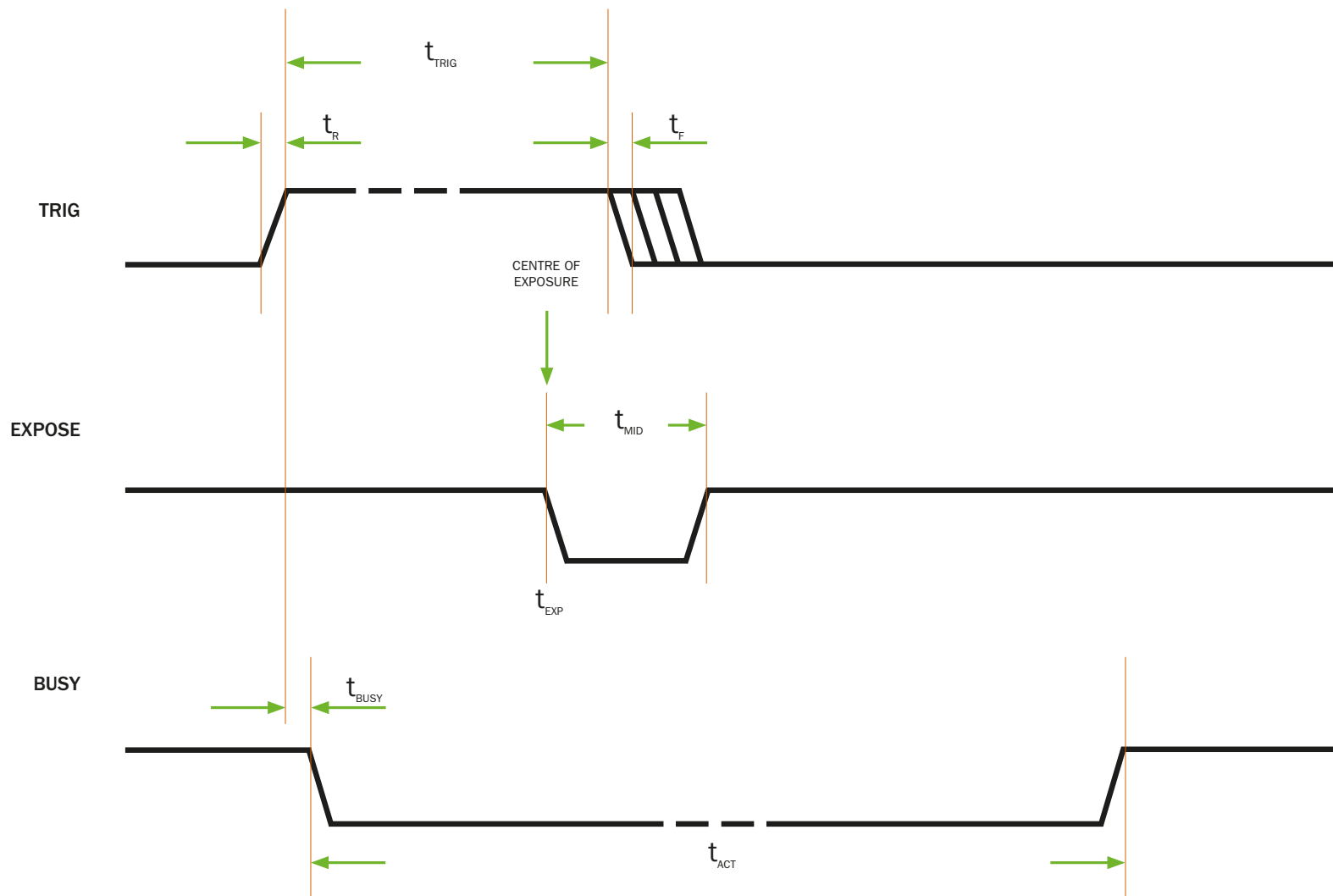

The electrical timing when using **EXPOSE** signal as full indicator:

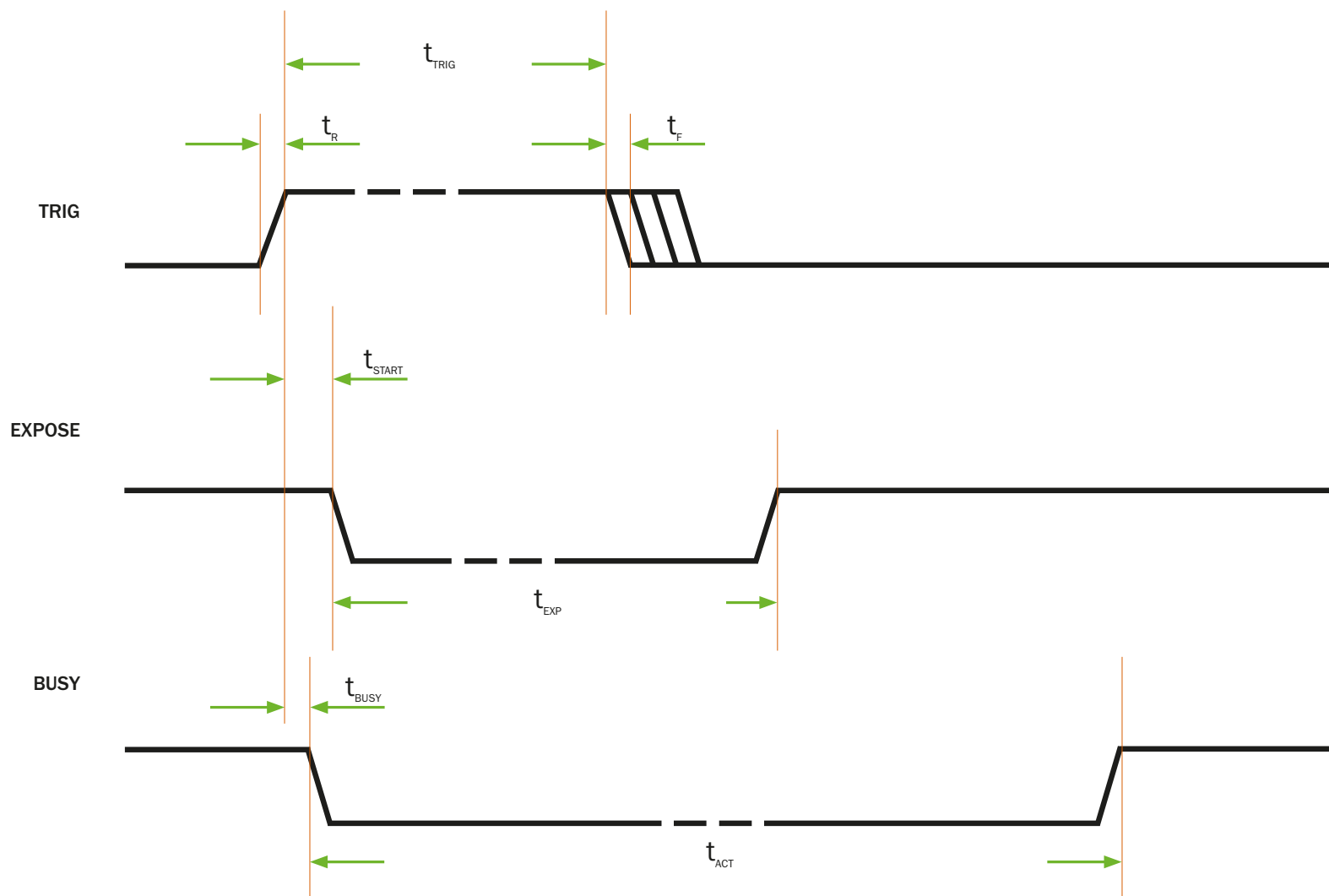

COVERAGE

COVERAGE VS ALTITUDE

The diagram below shows the ground coverage for the width of the image as a function of altitude.

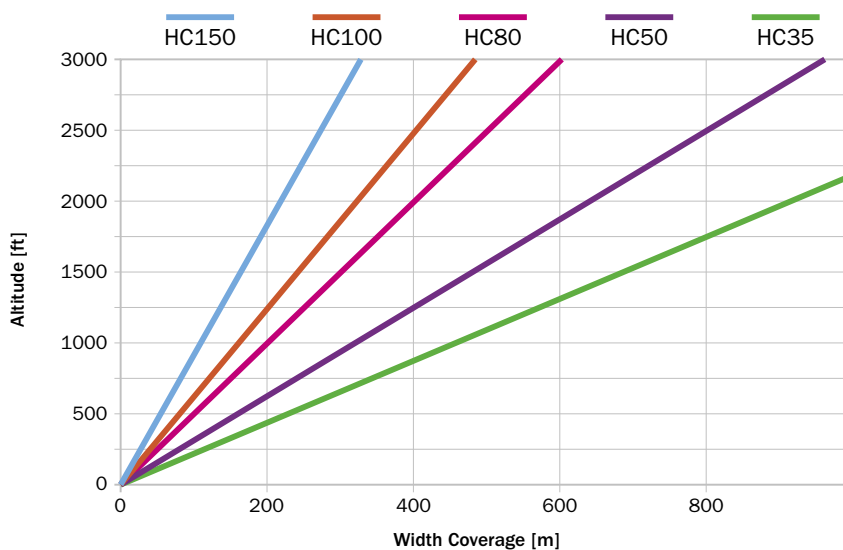
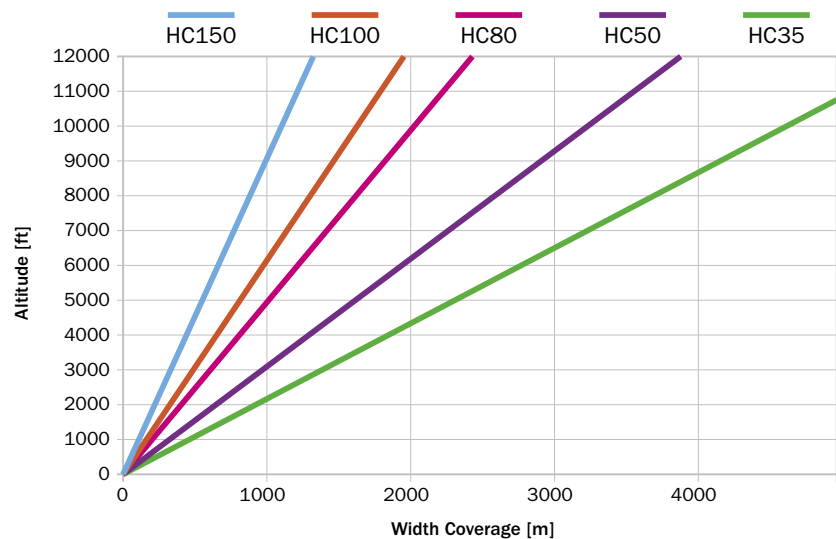

GSD VS ALTITUDE

The diagram below shows the Ground Sample Distance as a function of altitude.

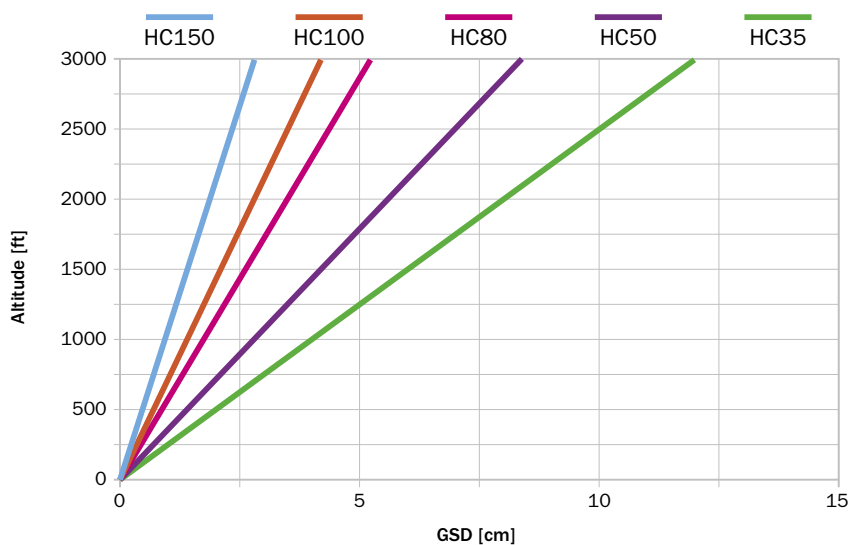
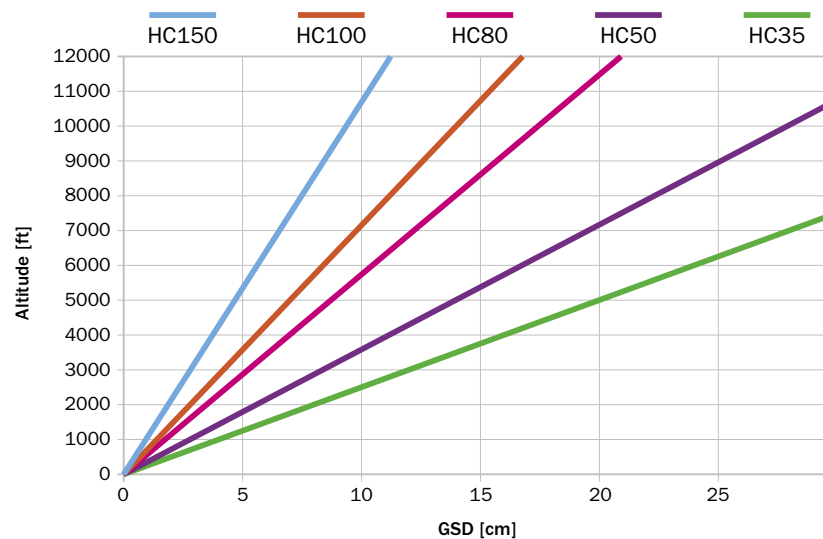

PHYSICAL DIMENSIONS

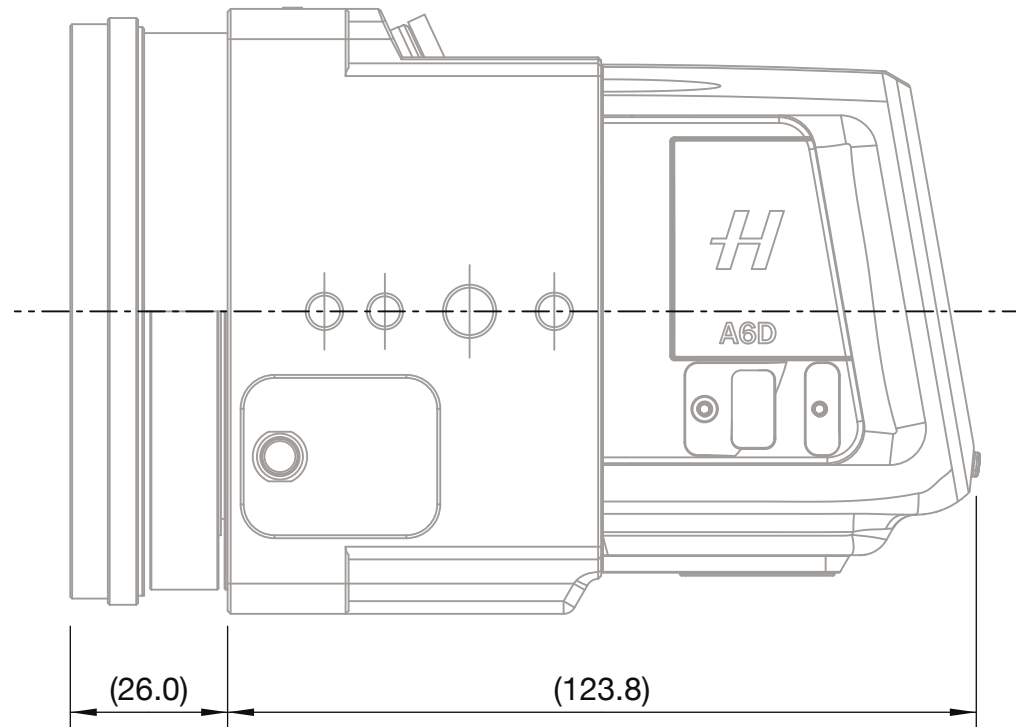

PHYSICAL DIMENSIONS

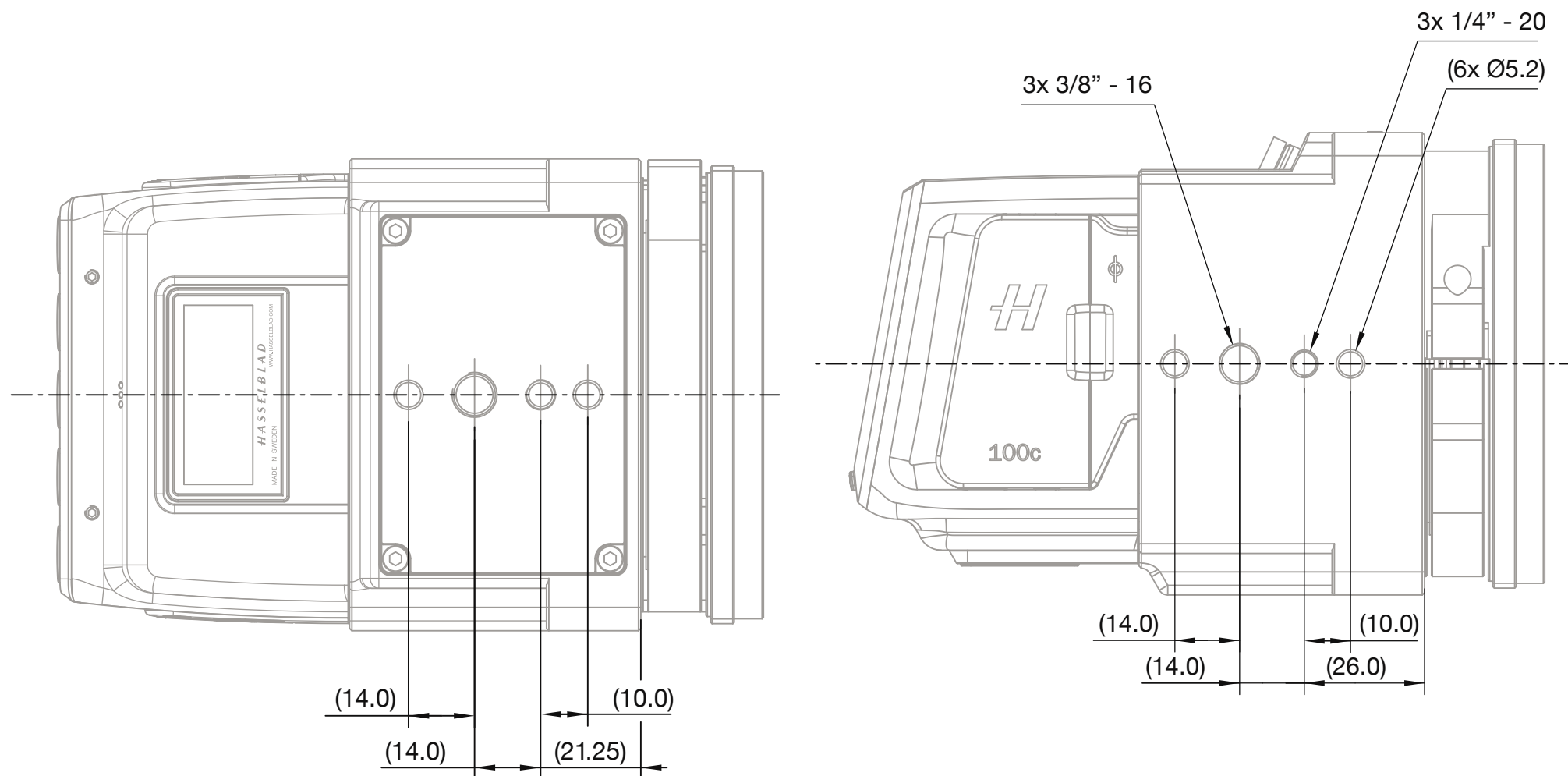

PHYSICAL DIMENSIONS

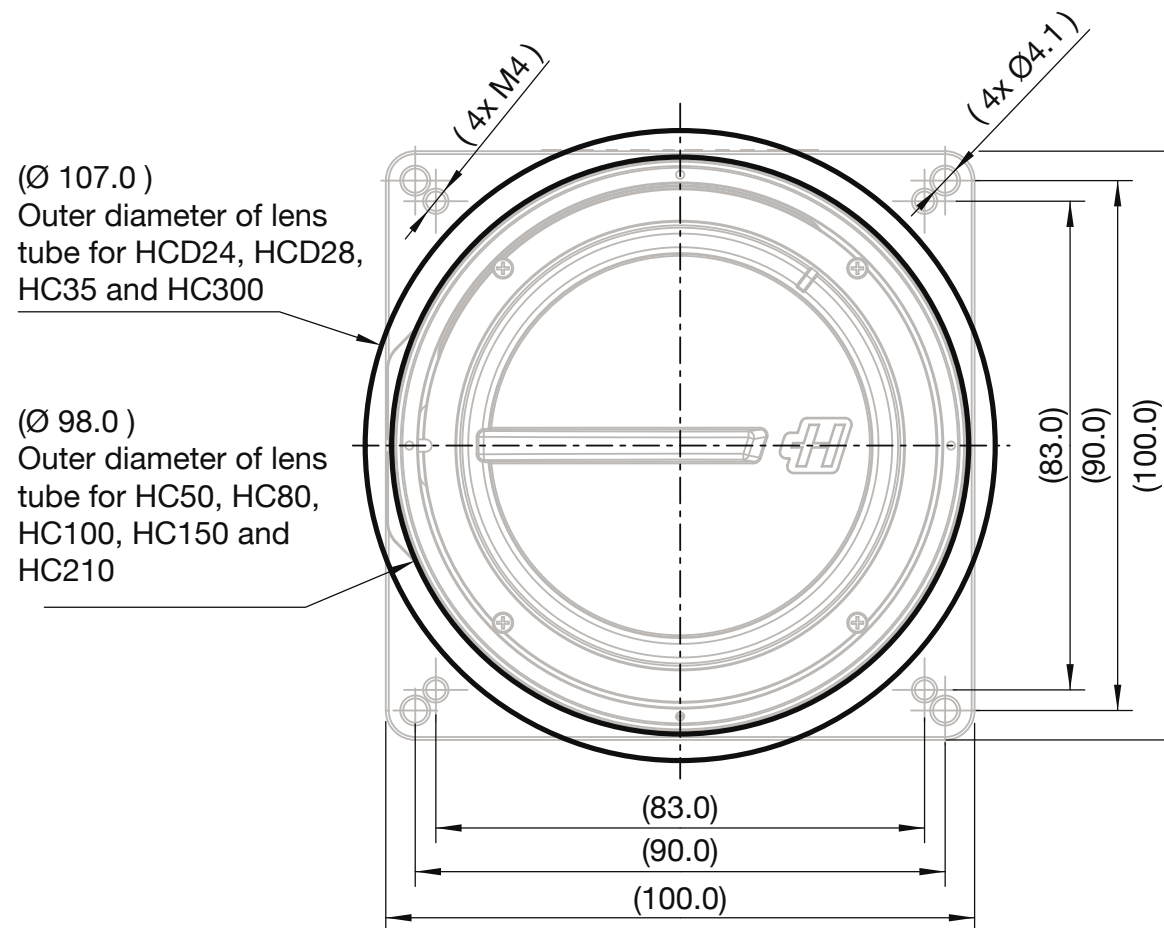

PHYSICAL DIMENSIONS

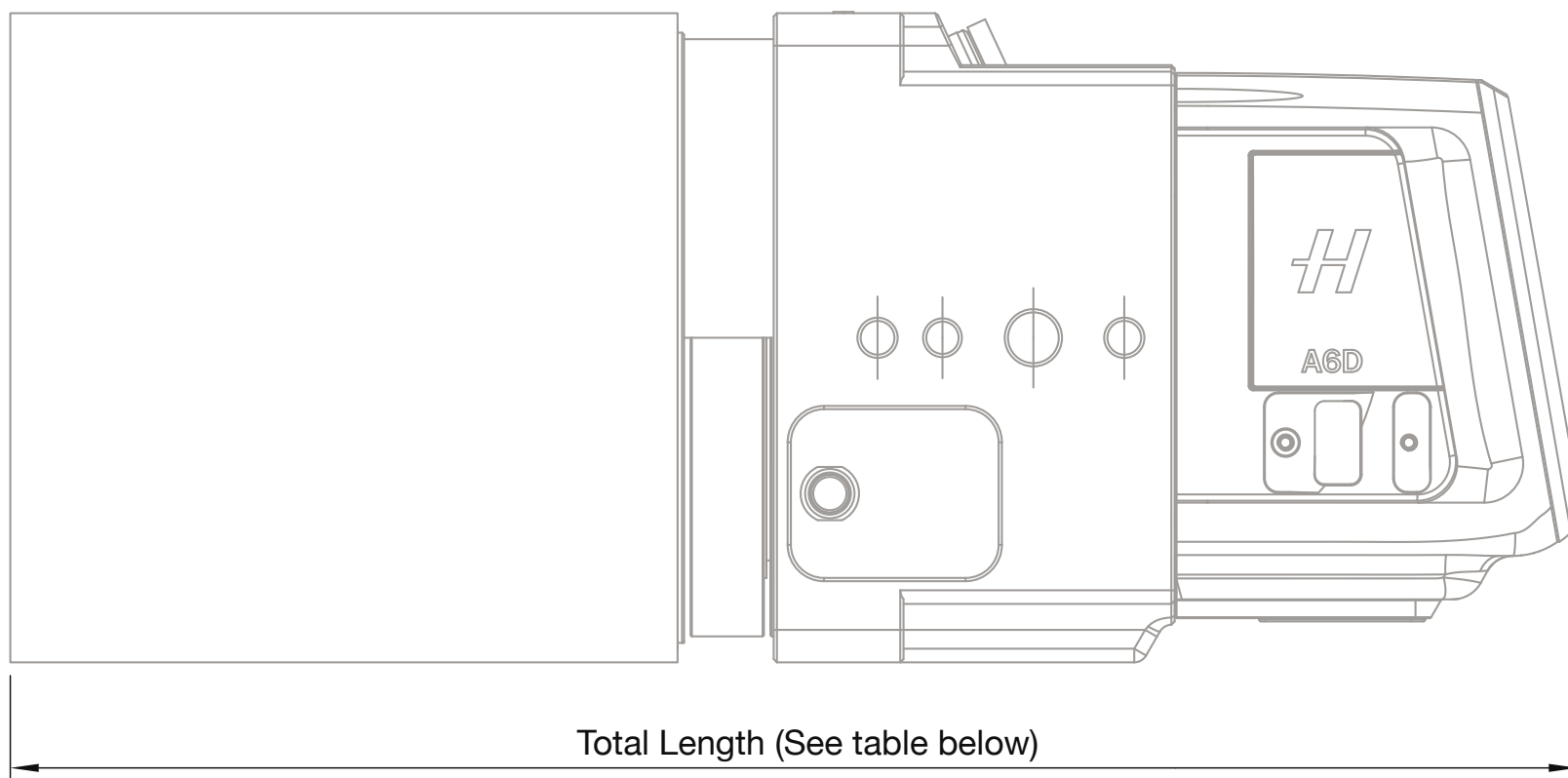

Total Length (See table below)

Lens	Tube Diameter	Total Length	Requires Adapter
HCD24	107 mm	221.0 mm	Yes
HCD28	107 mm	221.0 mm	Yes
HC35	107 mm	247.5 mm	Yes
HC50-II	98 mm	248.0 mm	No
HC80	98 mm	205.0 mm	No
HC100	98 mm	205.0 mm	No
HC150	98 mm	248.0 mm	No
HC210	98 mm	293.0 mm	No
HC300	107 mm	322.5 mm	Yes

ACCESSORIES

The following accessories are available for the A6D:

Item Description	Item Number
Control Cable	CPHB.00000012.01 ¹⁾
Power Cable	CPHB.00000022.01 ¹⁾
Multi Sync Cable	CPHB.00000013.01
Hand Release Cable	CPHB.00000021.01
USB3 Cable, Type C - Type A, 4.6 m	CPHB.00000505.01 ¹⁾
USB C Tether Tools Cable Lock	CPHB.00000506.01 ¹⁾
Lens Protection Tube for 24mm Lens	CPQT.HB000335.01
Lens Protection Tube for 28mm Lens	CPQT.HB000335.01
Lens Protection Tube for 35mm Lens	CPHB.00000014.01
Lens Protection Tube for 50mm & 150mm Lenses	CPHB.00000015.01
Lens Protection Tube for 80 & 100mm Lenses	CPHB.00000016.01
Lens Protection Tube for 210mm Lens	CPQT.HB000336.01
Lens Protection Tube for 300mm Lens	CPQT.HB000337.01
Adaptor Plate (P1)	CPHB.00000017.01
Hardcase	CPHB.00000018.01

1) Included as standard accessories with the A6D

FCC NOTICE

FCC CLASS A NOTICE FOR A6D-100C

This A6D-100c has been tested and found to comply with the limits for a Class A digital device, pursuant to Part 15 of the FCC Rules. These limits are designed to provide reasonable protection against harmful interference when the equipment is operated in a commercial environment. This equipment generates, uses, and can radiate radio frequency energy, and if it is not installed and used in accordance with the instruction manual, it may cause harmful interference to radio communications. Operation of this equipment in a residential area is likely to cause harmful interference, in which case the user will be required to correct the interference at his own expense.

FCC CAUTION

Any changes or modifications not expressly approved by the party responsible for compliance could void the user's authority to operate this equipment.

DISCLAIMER

Victor Hasselblad AB assumes no responsibility or liability for any errors or inaccuracies that may appear in this User Guide.

Victor Hasselblad AB assumes no responsibility or liability for loss or damage incurred during, or as a result of using Hasselblad software or products.

INDEX

Symboler

9 View Mode..... 33

A

About Menu 27
 Accessories 50
 Adapter plate 12
 Approval 39

B

Browse button..... 8
 Browsing 31
 Button Navigation..... 16

C

Cable Lock..... 13
 Camera Settings Menu 20
 Capture Details Mode..... 29
 Capture Rate 39
 Card View 34
 Cleaning..... 37
 Colour Definition 39
 Colour Management 39
 Combined Histogram 29
 Control connector A..... 8
 Control Connector A & B 40
 Control connector B..... 8
 Control Screen 18
 Coverage vs altitude 44
 Cover for External
 Connections 8
 Create New Folder 35
 Current limit..... 41

D

Date & Time Menu 25
 DC Power connector 8
 Delete Captures..... 31
 Digital capture unit 8
 Dimensions 39
 Display button..... 8
 Display Menu 24
 Disposal..... 4

E

Electrical Timings 42
 Exposure Metering 39

F

Favourite Functions..... 17
 FCC Class A Notice for A6D-100c 50
 File Format 39
 Firmware Update 27
 Firmware Updates 4
 Focal lengths 9
 Focusing..... 39
 Folder View 33
 Format 25
 Full Screen Preview 29

G

General Settings Menu 24
 GSD vs altitude 44

H

Host Connection Type 39

I

Image Menu..... 20
 Image Orientation..... 20
 Image Size..... 39
 IR Filter 39
 ISO Speed Range 39

L

Language Menu 26
 Lemo connector 40
 Lenses 9, 39
 Lens mount locking bolt..... 8
 Lens release button 8
 Lens shield..... 8, 11
 Live View Menu (Video)..... 23
 Luminance Histogram..... 29

M

Main Menu 17
 Menu button 8
 Mid exposure 42
 Mounting point..... 8
 Mounting the lens 11

N

Navigating the Menus 15

O

Operating Temperature 39
 Overlay..... 23

P

Parts and Components 8
 Physical Dimensions..... 45, 46, 47, 48
 Platform Support..... 39
 Plug Pin-out..... 40
 Power Connection..... 12
 Power Connector 40
 Power Supply 39
 Power & Timeouts Menu 26
 Preview Modes..... 29

Q

Quality Menu (Image)..... 21
 Quality Menu (Video) 22

R

Register your camera.....	4
Reset File Counter.....	27
Restrictions and Recommendations...	5

S

Saving images to a memory card.....	12
SDK	12
Select button	8
Sensor Dimensions	39
Sensor Type	39
Separate Histogram	29
Service Menu.....	27
Shooting Mode.....	39
Shutter Speed Range	39
Soft button	8
Software	39
Standard Preview	29, 30
Storage Capacity.....	39
Storage Media cover.....	8
Storage Menu	25
Storage Options	39
Synchronous connections	12
System Logic Supply Signals.....	40
System startup	40

T

Technical Specification.....	39
Tethered Operation	39
Total Length	48
Touch Screen Navigation	15
Tube Diameter.....	48

U

Usage	27
USB3 socket.....	8

V

Video Settings Menu	22
Voltage limit.....	41

W

Weight.....	39
-------------	----

Z

Zoom in and out.....	32
----------------------	----

HASSELBLAD
CREATE TO INSPIRE