

Nikon

F3 AF

INSTRUCTION MANUAL

NOMENCLATURE

① Aperture-direct-readout (ADR) window

② Camera body AF contacts

③ Depth-of-field preview button

④ Mirror lockup lever

⑤ Self-timer LED

⑥ Backup mechanical release lever

⑦ Anatomical grip

⑧ Exposure memory lock button

Viewfinder illuminator ⑬

Meter coupling lever ⑭

Meter coupling lever release button ⑮

Sync terminal ⑯

Lens mounting index ⑰

Lens release button ⑱

Reflex mirror ⑲

Lens mounting flange ⑳

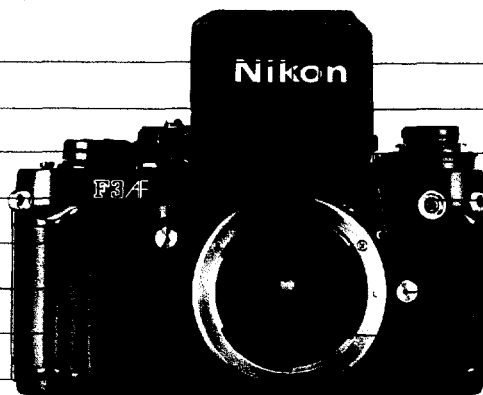

⑨ Viewfinder battery chamber (with lid)

⑩ Shutter speed index

⑪ Viewfinder illuminator button

⑫ Neckstrap eyelet

Finder mounting/release levers ㉑

ASA/ISO film speed/exposure compensation dial ㉒

Accessory terminal ㉓

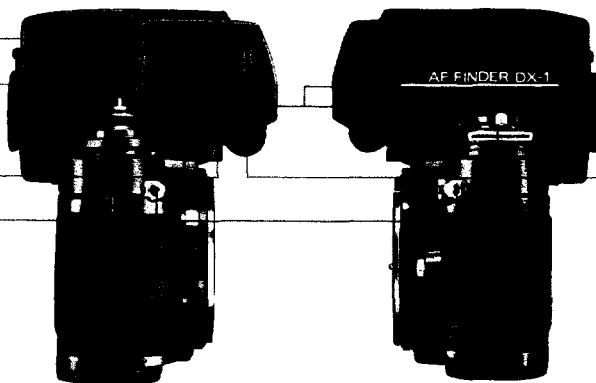

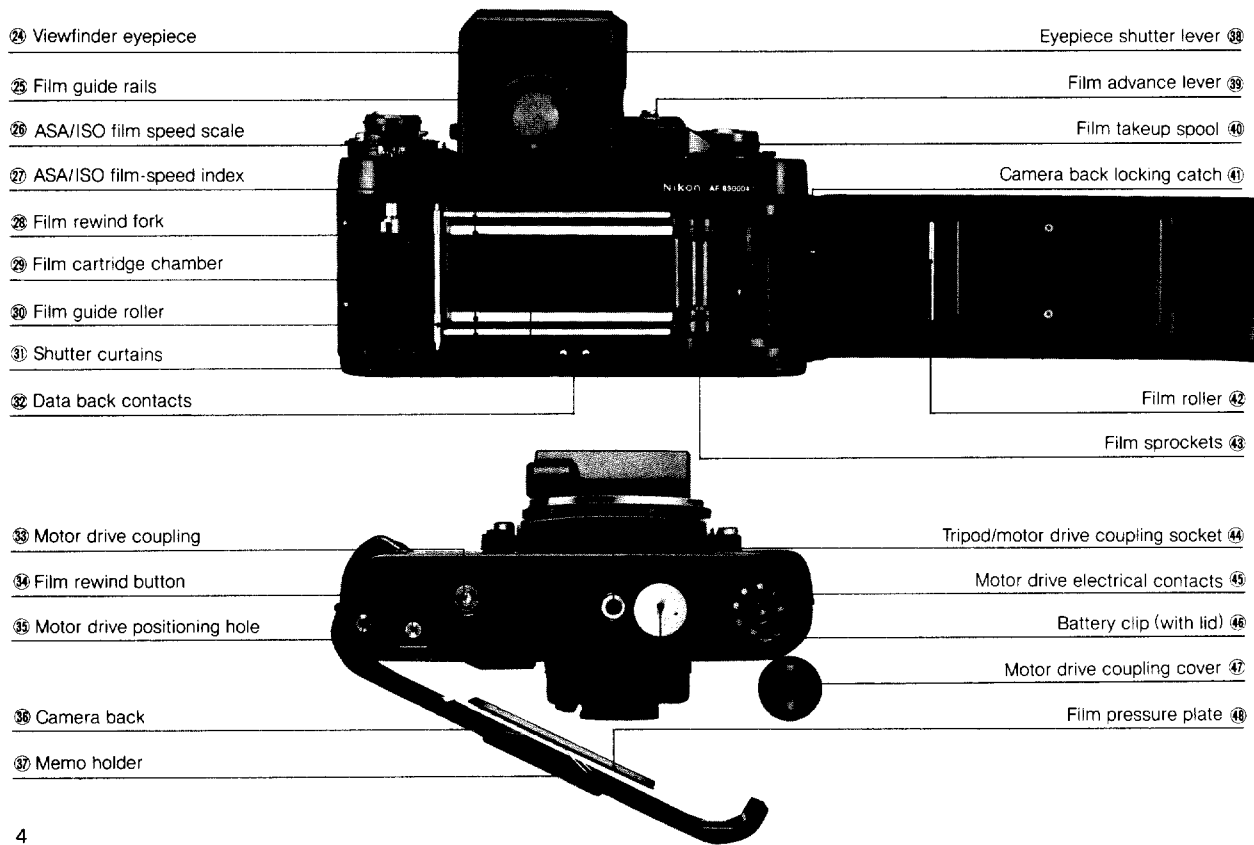

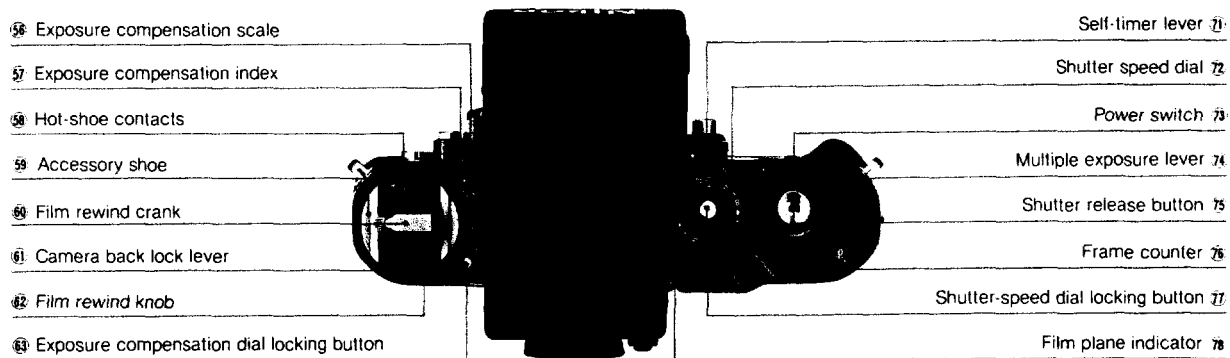
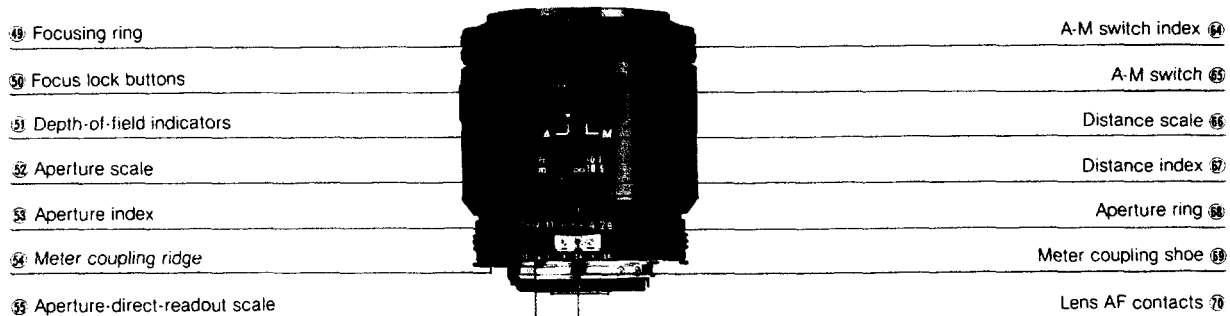

CONTENTS

NOMENCLATURE	3—5	FLASH PHOTOGRAPHY	48—51
FOREWORD	7	Accessory Shoe	49
BASIC OPERATION	8—19	Sync Terminal	50
FOCUS	20—28	Ready-Light	51
Autofocus	22—23	Nikon F3AF/Speedlight Combination Chart	51
Focus-Aid Operation	24	ACCESSORIES	52—65
Manual Focus	25	Interchangeable Viewfinders	52—53
Special Situations	26—27	Focusing Screens	54—55
EXPOSURE	28—41	Electronic Flash Equipment	56—57
Setting the Film Speed	29	Motor Drive MD-4	58—59
Setting the Aperture	30	Data Back MF-14	60
Setting the Shutter Speed	30—31	Close-Up Equipment	61—62
Automatic Exposure Control	32	Anti-Cold Battery Pack DB-2	63
Manual Exposure Control	33	Cable Release AR-3	63
Relationship Between Shutter Speed and Aperture	34—35	Rubber Eyecup	63
Depth of Field	36—38	Eyepiece Correction Lenses	63
Exposure Compensation	39—40	Filters	64
Stop-Down Exposure Measurement	41	Lens Hoods	64
OTHER CONTROLS	42—47	Camera Cases	65
Shutter Release Button	42	Neckstraps	65
Backup Mechanical Release Lever	42	Compartment Cases	65
Film Advance Lever	43	EV RANGE OF THE CAMERA	66—69
Frame Counter	43	TIPS ON CAMERA CARE	70—71
Eyepiece Shutter Lever	44	TIPS ON BATTERY USE	72
Self-Timer	44	ABOUT THE LIQUID CRYSTAL DISPLAY (LCD)	73
Mirror Lockup Lever	45	SPECIFICATIONS	74—76
Viewfinder Illuminator	45	IMPORTANT!	77
Multiple Exposure Lever	46		
Memo Holder	46		
Film Plane Indicator	47		
Infrared Focusing Index	47		

FOREWORD

Congratulations! You now own one of the most advanced, easy-to-use cameras on the market today.

Thanks to a TTL image displacement detecting system utilizing two SPD's built into the AF Finder DX-1, this camera offers you through-the-lens autofocus control with either of two AF-Nikkor lenses, the 80mm f/2.8 and the 200mm f/3.5 IF-ED. Thus, you can shoot fast-moving action while the subject remains in sharp focus. And like the regular Nikon F3, the shutter speed is set automatically to match the f/stop in use, so you never have to worry about getting the correct exposure. The F3AF also gives you focus-aid operation with the vast majority of Nikkor and Nikon Series E lenses having a maximum aperture of f/3.5 or faster, while regular manual focusing using the matte portion of the screen is possible with any lens.

Before actually taking pictures with the F3AF, you should familiarize yourself with its basic operation as presented in the first section. For more detailed explanations and special picture-taking situations, refer to the rest of the manual. A few minutes wisely invested now will pay off later in years of rewarding photographic experiences.

To insure proper service, make sure the Nikon Warranty Card is enclosed in the camera box.

BASIC OPERATION



1. Remove the battery clip⁴⁶ from the camera body.

Use a coin to twist the clip counterclockwise to unscrew it.

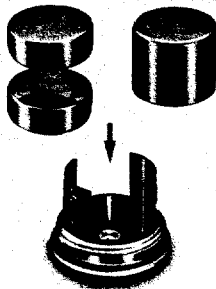

2. Load the batteries into the clip.

Wipe the battery terminals clean and insert the two 1.55V silver-oxide batteries supplied with the camera, making sure that the + signs are up. Two 1.5V alkaline-manganese batteries or one 3V lithium battery can also be used.

Caution: Keep batteries away from infants and small children. In case a battery is accidentally swallowed, call a doctor immediately as the material inside the batteries can cause serious problems.

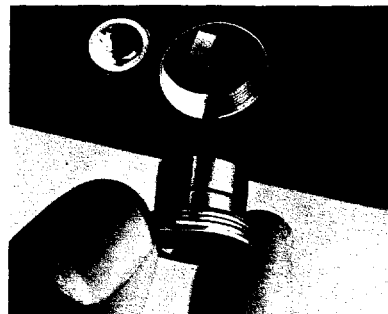

3. Reattach the battery clip.

Slip the battery clip back into the camera body and screw it tightly into place.



4. Remove the battery chamber lid 9 from the finder.

Apply pressure to the battery chamber lid located at the side of the viewfinder to slide it off.



5. Load the batteries into the finder's battery chamber.

Load two AAA-type batteries into the battery chamber, making sure the positive and negative (+ and -) terminals match the diagrams inside the holder.

Caution: NiCd batteries should not be used as they might cause an explosion.

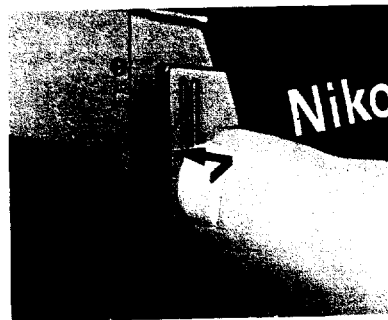

6. Reattach the lid.

While applying pressure to the batteries with the lid, slide it on until it clicks into place.

BASIC OPERATION—continued

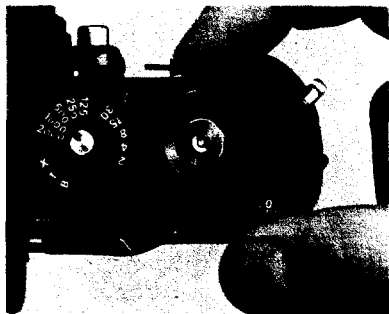

7. Move the power switch ⁷³ to uncover the red dot.

Turn the switch clockwise until it clicks into place. This makes the camera ready for exposure metering and autofocus shooting.

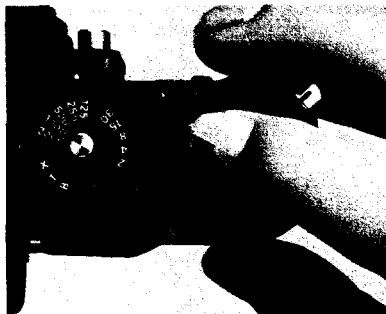

8. Depress the shutter ⁷⁵ release button halfway.

This activates the exposure meter and autofocus functions. Both stay on for 16 seconds after you take your finger off the button, then turn themselves off automatically to conserve battery power.

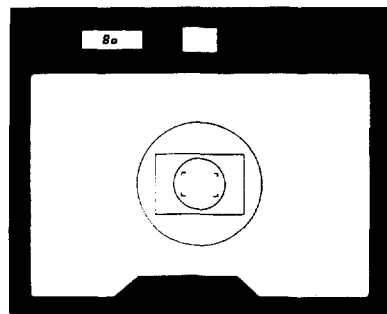

9. Check battery power.

Look through the viewfinder. Without a lens mounted on the camera body, the focus-impossible warning (red X-shaped LED) blinks or lights up continuously, while the liquid crystal display (LCD) shows the shutter speed. These displays indicate that the batteries have been properly installed and their power is adequate. If neither the red X nor the LCD appears, check battery installation in the camera body or replace the batteries in the body and check again. If the red X does not appear but the LCD does, check battery installation in the finder or replace the finder's batteries with a fresh set.

Note: If a lens is mounted on the camera, either the red X or one or both of the focus indicators (two red LED arrows) will light up.

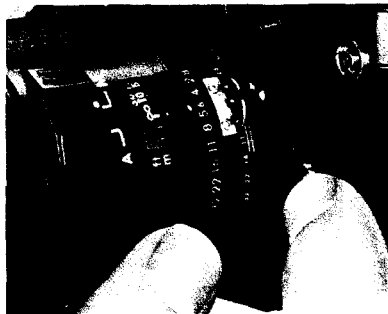
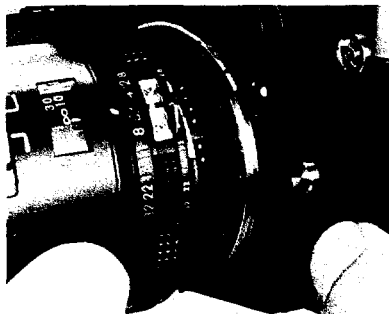

10. Mount the lens onto the camera.

First, make sure that the meter coupling lever 14 is locked in the "down" position. Grasp the lens by its lens barrel. Then, line up the aperture index 15 on the lens with the lens mounting index 17 on the camera body and twist the lens counterclockwise until it clicks into place. Confirm that the aperture index is right on top.

To remove: Push the lens release button 18 and turn the lens clockwise until the lens comes off.

Notes:

- 1) Lenses usable with the Nikon F3AF, plus DX-1 Finder, are listed on page 20.
- 2) Never touch the AF contacts 20 inside the camera's lens mounting flange 20 or those 19 on the lens bayonet mount.
- 3) When changing lenses with film loaded in the camera, be careful not to expose the mirror box to direct sunlight.

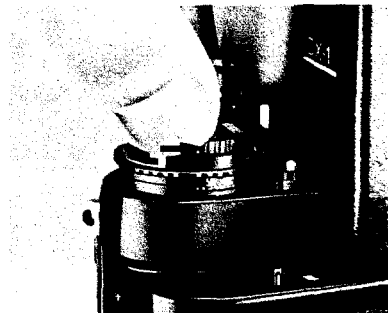

11. Open the camera back 36.

While pushing the camera back lock lever 36 counterclockwise with your thumb, lift the film rewind knob 37 and the camera back will pop open.

Note: If you have used a motor drive, be sure that the motor drive coupling cover 47 is returned to the camera's baseplate; otherwise, the film might be inadvertently exposed while shooting.

BASIC OPERATION—continued

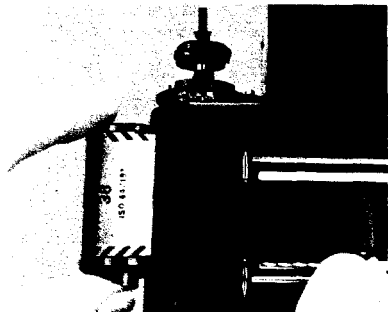

12. Install the film cartridge.

Drop the film cartridge into the film cartridge chamber **29** so that the film leader points towards the takeup spool **40**, and push the rewind knob back down into place.

Notes:

- 1) Any 35mm film cartridge can be used.
- 2) Handle film in the shade to avoid direct exposure to sunlight.

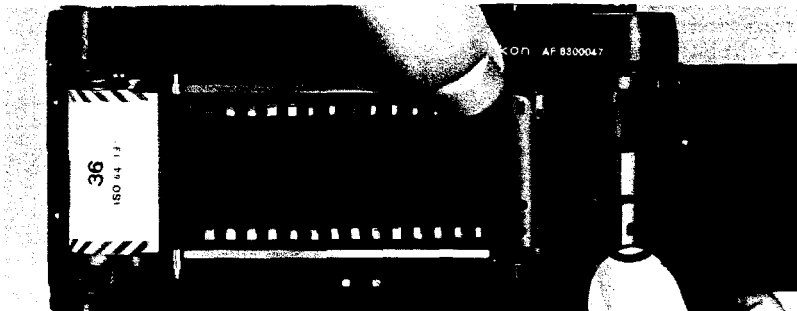

13. Insert the film leader in the takeup spool.

Pull the leader across the camera and insert it into one of the slots in the film takeup spool. Advance the takeup spool slightly with your finger to engage the film's perforations with the teeth of the takeup spool and sprocket **43**.

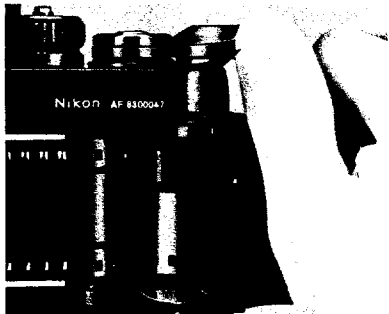

14. Wind the film advance lever ³⁹ to advance film onto the takeup spool.

Wind the film advance lever and depress the shutter release button until the film sprockets engage the perforations on the edges of the film.



15. Close the camera back.

Make sure that the perforations are perfectly meshed with the sprockets and that the film is set between the film guide rails ²⁵. Then, close the camera back until it snaps shut.

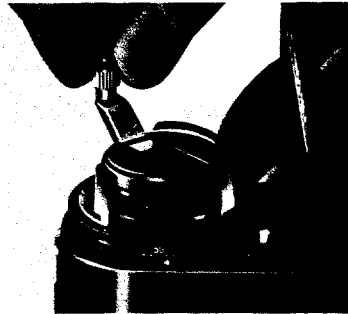

16. Take up the film slack.

Fold out the film rewind crank ⁶⁰ and rotate it in the direction of the arrow until it stops. Then fold the crank back in.

BASIC OPERATION—continued

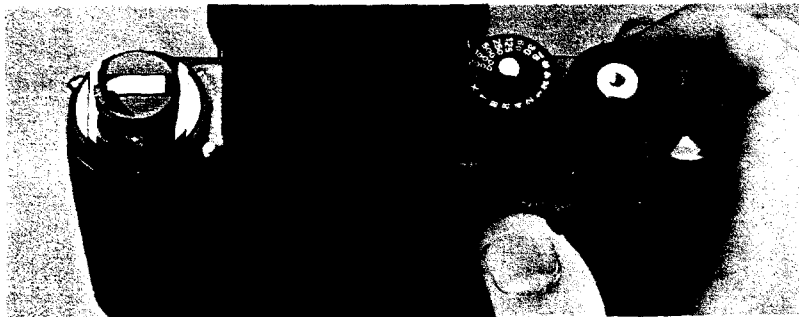

17. Make blank exposures until the frame counter ⁷⁶ reaches frame one.

To dispose of the first few frames exposed during film loading, continue to alternately advance the film and depress the shutter release button until the counter reaches frame one (the first dot past 0). While making blank exposures, check that the rewind knob is rotating, indicating the film has been loaded correctly and is being advanced. If the knob does not rotate, reload the film.

Notes:

- 1) When making blank exposures, set the shutter speed dial ⁷⁵ to A or 1/125 sec. or above, and the shutter will be released at 1/80 sec. with 80 or M 80 displayed by the LCD in the viewfinder.
- 2) Do not take pictures prior to the first frame, as the meter does not function until the counter reaches one.

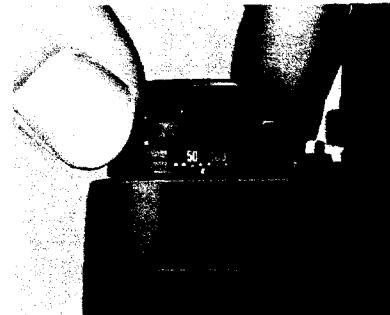

18. Set the ASA/ISO film speed.

Lift up the ASA/ISO film speed dial ⁷⁷ and rotate it in either direction until the white dot ⁷⁷ is opposite the ASA/ISO film speed in use. Also make sure that the exposure compensation index ⁵⁷ is set to the red 0. This programs the camera's exposure meter so that it may provide a proper exposure for the type of film being used.

Note: The film speed is printed on the film carton and cartridge. Details on setting the dial to intermediate settings can be found on page 29.

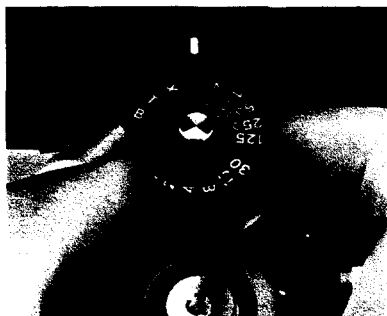

19. Set the shutter speed dial ⁷² at **A**.

Rotate the shutter speed dial until the **A** is opposite the shutter speed index ⁷⁰. The built-in locking mechanism ensures that the dial cannot be accidentally shifted from the **A** (Auto) position during shooting. To set the dial to other positions, turn the dial while depressing the shutter-speed dial lock button ⁷⁷.



20. Slide the A-M switch ⁶⁵ on the AF-Nikkor lens to **A**.

Slide the switch as far as it will go.

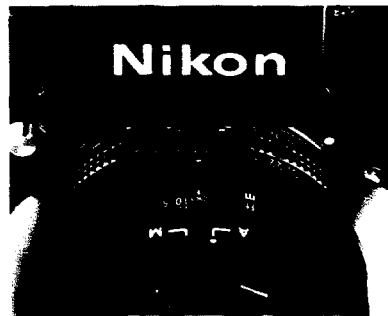

21. Set the f-number on the lens.

Turn the aperture ring ⁶⁶ on the lens until the desired f-number is opposite the aperture index. The selected f-number appears in the viewfinder for convenient reference. Use the following suggestions as a guide in setting the f/stop on the lens (when the 80mm f/2.8 is used):

Indoors: f/2.8~f/4

Outdoors (cloudy): f/4~f/8

Outdoors (clear): f/8~f/16

Outdoors (clear at the beach or in the mountains): f/16~f/32

Note: Depending on your preference, the depth of field as well as the shutter speed can be controlled by your selection of the shooting aperture. For more information, refer to page 36.

BASIC OPERATION—continued



22. Hold the camera steady.

As you look through the viewfinder, use your left hand to cradle the camera, with your fingers wrapped around the lens and your thumb beside the focus lock button , while your elbow is propped against your body for support. Use the index finger of your right hand to depress the shutter release button and your thumb to wind the film advance lever. Wrap the other fingers of your right hand around the camera body. You can adapt this basic posture to both *horizontal* and *vertical* format shooting. To hold the camera steady, it is advisable to lean on or against something strong and stable (e.g., a wall).



23. Compose the picture.

Look through the viewfinder, compose your photo with the main subject (if possible, a subject's vertical line) in the center of the focusing frame to assure correct focus and exposure.

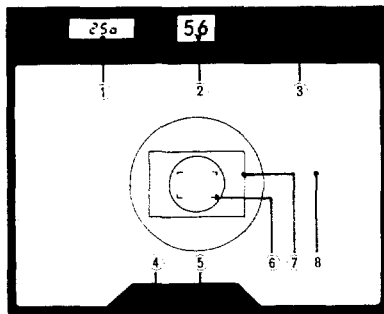
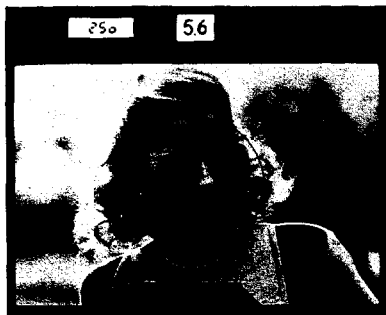

- ① LCD exposure information
- ② ADR f-number
- ③ Flash ready-light
- ④ Focus-impossible warning
- ⑤ Focus indicators: near-focus arrow;
far-focus arrow
- ⑥ Central focusing frame
- ⑦ Half-mirror
- ⑧ Fine matte/Fresnel field

24. Depress the shutter release button halfway and check both the exposure and focus displays.

While looking through the viewfinder, depress the shutter release button halfway to turn on the exposure meter and auto-focus functions. The LCD indicates the automatically selected shutter speed to match the aperture set on the lens. As long as neither +2000 nor -8" appears in the shutter speed display, the camera gives the correct exposure. If either indication appears, adjust the aperture ring on the lens until a desirable shutter speed is indicated, referring to page 32. The *f*-number you have set on the lens is also shown in the aperture-direct-readout (ADR) window. When both red arrows light up, they indicate that the image is in focus. If the red X appears, refer to page 26.

BASIC OPERATION—continued

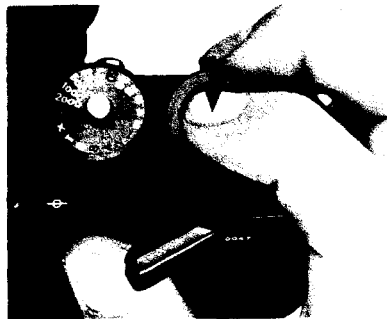

25. Take the picture.

Depress the shutter release button all the way down; apply light but steady pressure with the ball of your index finger to avoid camera shake which might result in a blurred image.

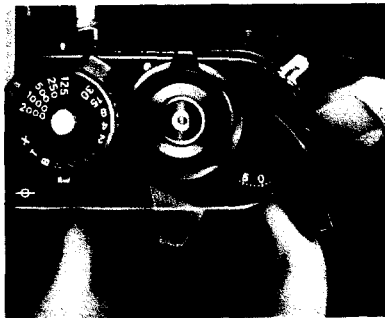

26. Advance the film.

Stroke the film advance lever to transport the film to the next frame.

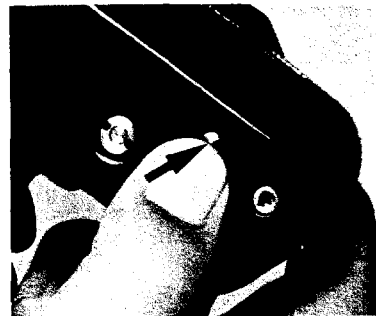

27. Press the rewind button ³⁴.

When the film reaches the end of the roll, the film advance lever will stop working. Then, turn the camera upside down and press the film rewind button, so that the exposed film can be rewound back into its cartridge. You do not have to continue depressing the button.



28. Rewind the film.

Lift the film rewind crank and turn it in the direction of the arrow. When you feel the tension lessen, continue winding one or two more turns until the film leader is rewound completely back into the cartridge.

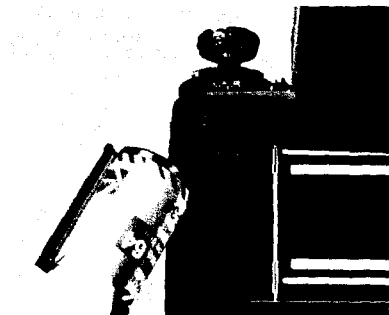

29. Remove the film cartridge.

Push the camera back lock lever counter-clockwise as you lift the film rewind crank to open the camera back. Take out the film cartridge. Avoid unloading film in direct sunlight.

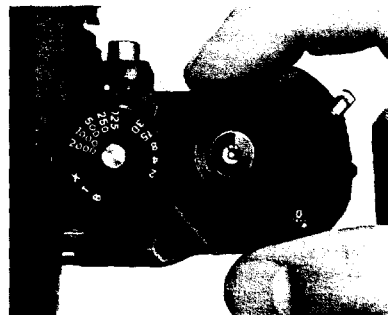

30. Turn the camera off.

Turn the power switch off while the camera is not in use. This prevents inadvertent battery drain in case the shutter release button is accidentally depressed.

FOCUS

The Nikon F3AF features a through-the-lens autofocus system which takes the guesswork out of focusing: just point the camera at what you want to photograph, depress the shutter release button $\frac{1}{2}$ halfway, and watch the subject literally snap into sharp focus... automatically.

The system consists of three parts: the special F3AF camera body, the AF Finder DX-1, and an AF-Nikkor lens, either the 80mm f/2.8 or the 200mm f/3.5 IF-ED. The AF Finder DX-1 is interchangeable and covers approx. 92% of the image area of the actual photograph, meaning that the final photograph will be larger than the image seen in the viewfinder. The focusing screen is built into the bottom of the viewfinder and cannot be interchanged. However, when other Nikon F3 interchangeable viewfinders are used with the F3AF, you have a choice of 20 interchangeable focusing screens (refer to page 55).

Nikon's autofocus system is unique in that it features exceptionally quick response, allowing you to keep up with active, fast-moving subjects.

The Nikon F3AF offers you three different ways of focusing:

1) autofocus, 2) focus-aid operation (using the focus indicators inside the finder), or 3) manual focus (using the matte portion of the focusing screen). As shown in the following table, however, only AF-Nikkor lenses are usable for autofocus. With other lenses having maximum apertures of f/3.5 and faster, you can use the focus indicators as a guide in focusing as you manually rotate the lens focusing ring $\frac{1}{2}$.

Note: Because of the cropping which occurs in the case of mounted slides or regular snapshot-size prints, the actual picture might come out slightly smaller than the image seen in the viewfinder.

Usable Lenses

Focusing method	Lens
Autofocus	AF-Nikkor 80mm f/2.8, AF-Nikkor 200mm f/3.5 IF-ED
Focus-aid operation	Nikkor (including AF-Nikkor) and Nikon Series E lenses with a maximum aperture of f/3.5 or faster
Manual focus	Nikkor (including AF-Nikkor) and Nikon Series E lenses

Notes:

- 1) Even with lenses slower than f/3.5, the focus indicators will light up when the shutter release button is depressed halfway. This indication, however, is not reliable.
- 2) Although the following Nikkor lenses have a maximum aperture of f/3.5 or faster, they cannot be used for focus-aid operation: 16mm f/3.5, 20mm f/3.5, 28mm f/3.5, 135mm f/3.5, Micro 55mm f/3.5, PC 28mm f/3.5, PC 35mm f/2.8, and PC 35mm f/3.5; the Micro-Nikkor 55mm f/2.8 cannot be used at closer than 280mm; the Zoom-Nikkor 35-105mm f/3.5-1/4.5 can be used only at 35mm zoom setting.
- 3) When the Nikon Teleconverter TC-14, 200 or 300 is attached to the lens and it makes the lens' effective aperture slower than f/3.5, the camera's autofocus and focus-aid operation cannot be used.
- 4) The following lenses cannot be mounted on the F3AF with the DX-1 Finder: Nikkor 13mm f/5.6, Reflex-Nikkor 500mm f/8, and Reflex-Nikkor 1000mm f/11.
- 5) Certain filters cannot be used for autofocus/focus-aid operation. (For details, please refer to page 64.)

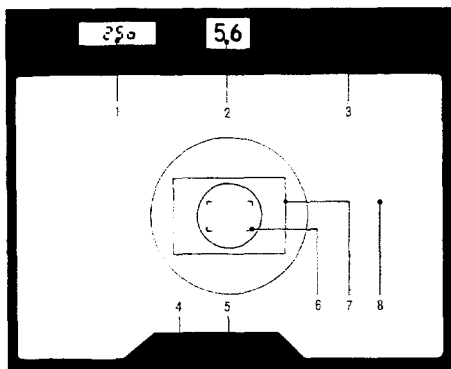

- ① LCD exposure information
- ② ADR f-number
- ③ Flash ready-light
- ④ Focus-impossible warning
- ⑤ Focus indicators: near-focus arrow; far-focus arrow
- ⑥ Central focusing frame
- ⑦ Half-mirror
- ⑧ Fine matte/Fresnel field



in focus



far focus (the lens is focused behind the subject)



near focus (the lens is focused in front of the subject)



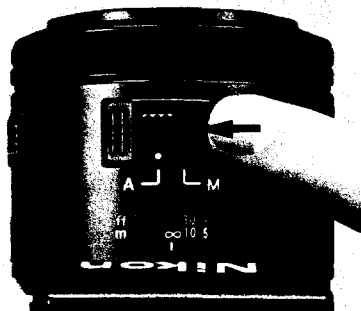

autofocus or focus-aid operation is impossible. (This warning also lights up momentarily at the start of autofocus or focus-aid operation, if there is a big difference between the actual camera-to-subject distance and the lens distance setting.)

FOCUS—continued



Autofocus

With the lens A-M switch  set at A, depressing the shutter release button halfway turns on the camera's autofocus control (as well as the exposure meter). At the same time, either the focus indicator(s) or the focus-impossible warning in the viewfinder light up and the lens begins to focus automatically. Note that the main subject (if possible, a subject's vertical line) should be centered inside the central focusing frame in the viewfinder. Autofocus continues for 16 sec. even after you remove your finger from the button. When the subject is in focus, focusing stops and both red arrows light up.

If there is a big difference between the actual camera-to-subject distance and setting on the lens distance scale , the red X lights up momentarily but disappears as soon as focusing begins. If the subject is closer than the closest distance to which the lens can focus, either the far-focus arrow () or the red X lights up continuously. However, when the red X blinks or lights up continuously, this indicates that the autofocus system does not

function well with the particular subject or shooting situation (please refer to page 26 for further details).

Notes:

- 1) After taking a picture during autofocus operation, the lens will continue to focus for 16 sec. after you remove pressure from the shutter release button. To stop the lens movement at any time to conserve battery power, slide the A-M switch to M. Immediately lens movement stops, but the red arrow(s) or red X remain on for 16 sec. until switched off automatically.
- 2) While shooting fast-moving subjects, one or both of the red arrows may blink to show that the image is quite close to the in-focus zone; for ordinary snapshots, taking the shot even in this situation can produce satisfactory results. However, if sharp focus is mandatory, wait until both red arrows light up continuously.
- 3) When the batteries in the viewfinder are nearly exhausted, autofocus becomes slow or may even stop, even though the red arrow(s) or red X remain lit. In this case, replace the batteries in the finder at your earliest convenience, or set the A-M switch to M and turn the focusing ring manually using the red arrows as a guide.

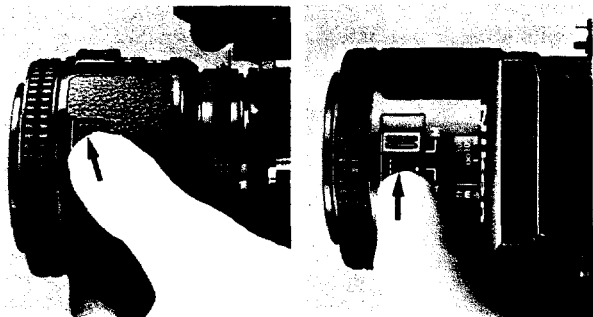

Focus lock

The AF-Nikkor lens has two focus lock buttons ∞ on the lens barrel, one on the side and the other on the A-M switch. You can use either of these buttons, depending on your choice of horizontal- or vertical-format shooting. During autofocus operation, depressing the focus lock button allows you to lock in the autofocus distance setting on the lens. Autofocus begins once again as soon as you release the button.

To take pictures with the main subject off-center, first center the main subject within the focusing frame in the viewfinder, depress the shutter release button halfway and make sure both focus indicators light up; then depress the focus lock button and, while holding it in, recompose and shoot.





Notes:

- 1) With the focus lock button held down, the in-focus indication (▶◀) may change in the following two cases: 1) when you once again depress the shutter release button halfway after the camera's automatic 16-sec. switch has turned off the indication, or 2) just after you have taken a picture. However, regardless of the focus indication change, the distance set on the lens is still the same as when you depressed the focus lock button.
- 2) When taking pictures in the automatic exposure mode with the main subject off-center, you must also depress the memory lock button ∞ to get the correct exposure. For more information, refer to page 40.

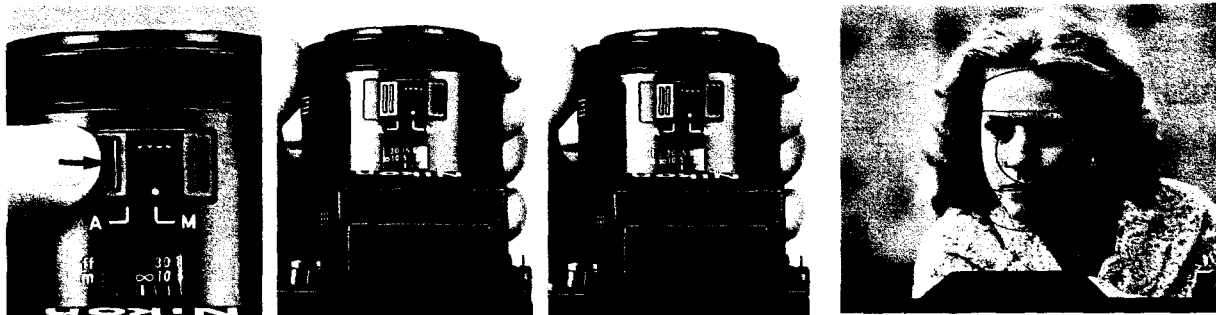
FOCUS—continued



Focus-Aid Operation (Using the Focus Indicators)

With the AF-Nikkor's A-M switch  set at M, or with other Nikkor or Nikon Series E lenses having a maximum aperture of f/3.5 or faster (as listed on page 20), you can use the focus indicators as a guide as you rotate the lens focusing ring. First, center the main subject (if possible, a subject's vertical line) within the focusing frame; then depress the shutter release button halfway to make the red arrows light up (focus information stays on for 16 sec. after removing your finger). If only the far-focus arrow () lights up, this indicates that the lens is focused behind the subject, whereas the near-focus arrow () indicates that the lens is focused in front of the subject. These red arrows are very convenient, because they tell you in which direction to turn the focusing ring: just turn in the direction of the arrow. When the image is in focus, both red arrows light up continuously. When there is a big difference between the actual camera-to-subject distance and distance set on the lens, the focus-impossible warning appears. In this case, turn the focusing ring until one of the red arrows lights up; then continue to turn the

ring until both arrows are lit, indicating sharp focus. If only the far-focus arrow () remains lit after the ring has been rotated fully counterclockwise, this means the subject is closer than the closest focusing distance of the lens. If the subject is much closer than the closest focusing distance of the lens, the red X will light up continuously.

In case the red X blinks or lights up continuously and does not disappear even after the focusing ring is turned, this indicates that the focus-aid indication system does not function well with the particular subject or shooting situation (please refer to page 26 for further details).

Note: While shooting fast-moving subjects, one or both of the red arrows may blink to show that the image is quite close to the in-focus zone; for ordinary snapshots, taking the shot even in this situation can produce satisfactory results. However, if sharp focus is mandatory, continue to rotate the focusing ring until both red arrows light up continuously.

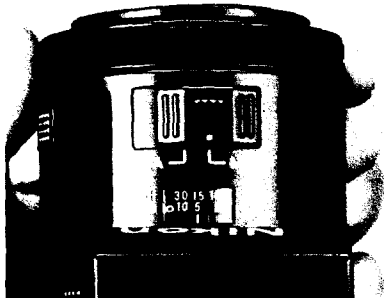

Manual Focus (Using the Matte Portion of the Focusing Screen)

Manual focus is required in the following cases: 1) when the batteries in the DX-1 finder are exhausted, 2) when you are using a lens which cannot provide autofocus or focus-aid operation, 3) when the focus-impossible warning blinks or lights up continuously, or 4) when you simply want to focus the lens yourself. With an AF-Nikkor lens, set the A-M switch ∞ to M; then turn the lens focusing ring until the image on the matte portion of the screen inside the viewfinder looks sharp and clear. With all other lenses, rotate the focusing ring in the normal manner.

Note: With the A-M switch on the AF-Nikkor lens set at A, you cannot shift the lens distance setting by turning the focusing ring.

FOCUS—continued

Special Situations

The F3AF provides autofocus and focus-aid operation in the majority of cases, including such difficult situations as fast-moving sports events, subjects seen through glass, or scenes containing point light sources, such as the flame from a candle or a streetlight at night. However, if the overall subject is dark in tone (e.g. when the illumination level is less than EV 4 at ASA/ISO 100), low in contrast, or lacks a distinct vertical line, the focus-impossible warning blinks or glows continuously to inform you that the camera's TTL image displacement detecting system will not work. In this case, you can set the lens' A-M switch to M and focus on the main subject manually using the matte portion of the focusing screen. As an alternative, perform autofocus or focus-aid operation using another subject, if available, which is located at the same distance as the one you want to photograph; then, with the focus lock button depressed on autofocus or without changing the distance setting in focus-aid operation, point the camera at the original subject and take the picture.

Dark subject (Illust. 1)

The red X blinks to show insufficient scene brightness. In this case, focus manually, or perform autofocus/focus-aid operation on an alternate subject at the same distance which is lighter in tone.

Low-contrast subject (Illust. 2), small or finely detailed subject (Illust. 3)

The red X lights up continuously. In this case, focus manually, or perform autofocus or focus-aid operation on an alternate subject at the same distance which has more contrast or is larger.

Subject with no vertical lines (Illust. 4)

The red X glows continuously. In this case, turn the camera vertically and perform autofocus or focus-aid operation, or focus manually; alternatively, perform autofocus or focus-aid operation using an alternate subject at the same distance which has vertical lines.

Subject with high reflectivity (Illust. 5), backlit subject (Illust. 6), or scene with both far and near subjects (Illust. 7)

In these cases, both red arrows or the red X light up continuously. If the red X appears, focus manually. If both red arrows are lit, use the matte portion of the screen to check focus. If your desired subject is out of focus, then focus manually. If it is in focus, take the shot.

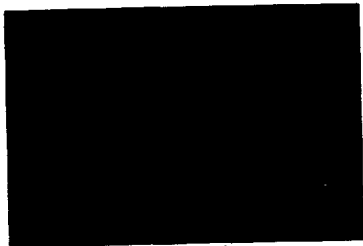

(Illust. 1)

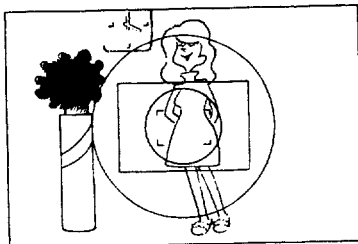

(Illust. 2)

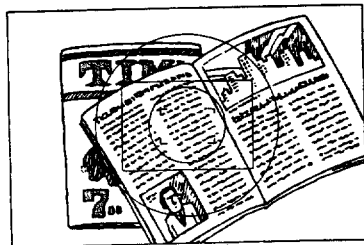

(Illust. 3)

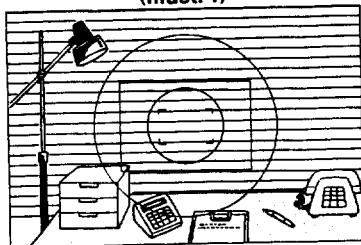

(Illust. 4)

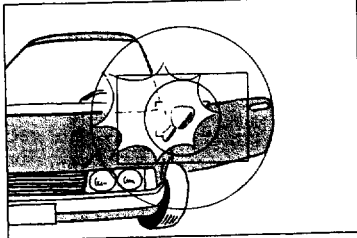

(Illust. 5)

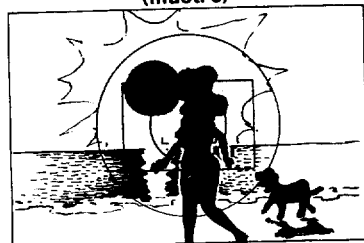

(Illust. 6)



(Illust. 7)

EXPOSURE



To match the convenience of autofocus, the Nikon F3AF features aperture-priority auto exposure. All you do is set the camera at A (Auto) and fire away. Light is automatically measured through the lens at full aperture, and the correct shutter speed is electronically determined to match the aperture in use. The F3AF also lets you select the shutter speed manually for complete creative control. Because the fast-reacting SPD metering cell is located in the camera body below the reflex mirror , you have full metering capabilities even with an interchangeable viewfinder attached. Metering is centerweighted; 80% of its sensitivity is concentrated in the 12mm ϕ center spot of the focusing screen, while the remaining 20% is distributed over the rest of the screen. To get the correct exposure, center the main subject in the finder. There are three factors involved in determining exposure: film speed, aperture, and shutter speed. All must be set correctly to get the proper exposure.

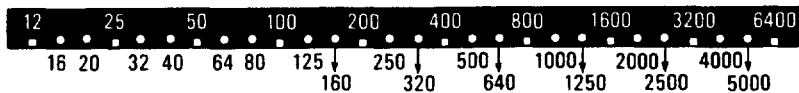
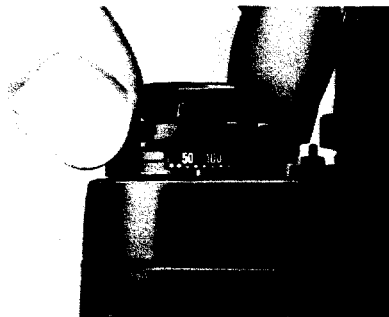

Setting the Film Speed



To program the F3AF to give the correct exposure with a particular film, you must first set the camera to the correct film speed. The film speed, represented by an ASA/ISO number, is a numerical rating of the film's sensitivity to a given amount of light: the higher the number, the greater the sensitivity, and vice versa. This number is printed on the film carton and the cartridge itself. To handle all film types, the camera's ASA/ISO dial  has settings from ASA/ISO 12 to 6400. Two dots between each pair of ASA/ISO numbers stand for intermediate settings, such as 64, 80, etc. The table above gives the speeds for all intermediate settings.

Note: In certain situations, you can set the ASA/ISO dial to a setting which is different from the recommended film speed. For example, some photographers rate their color slide film at a slightly higher ASA/ISO setting to produce intentional underexposure for more color saturation. Or when shooting in very low light, you can "push" high-speed black-and-white film by doubling or quadrupling the ASA/ISO, then overdeveloping it to compensate for the underexposure.

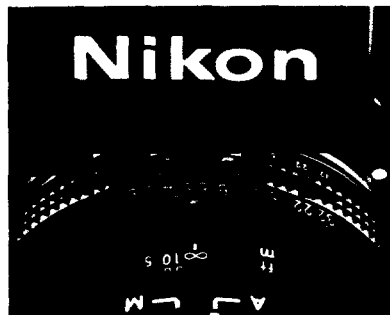
EXPOSURE—continued



Setting the Aperture

The second factor in determining exposure is the shooting aperture. Aperture, or the opening formed by the diaphragm inside the lens, controls the amount of light allowed to pass through the lens and strike the film; it also controls depth of field (see page 36 for more information). In low light, you are generally required to use large apertures (indicated by f-numbers which are low in numerical value, e.g. f/2.8), while in bright light, small apertures are called for (e.g., f/16). The aperture ring  features click-stops at whole f/stops but is continuously variable throughout its entire range. With the exception of a few special lenses, Nikkor and Nikon Series E lenses enable full-aperture light measurement regardless of the aperture setting. These lenses have automatic diaphragms, meaning that the diaphragm stops down to the preset aperture only at the instant of exposure. To keep you fully informed, the aperture in use appears in the ADR window  inside the camera's viewfinder.

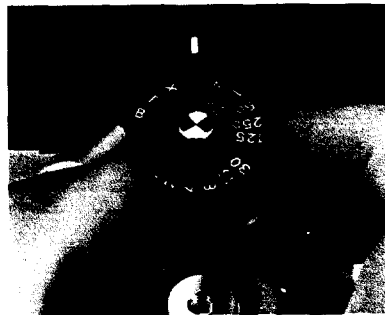

Setting the Shutter Speed

Shutter speed, or the length of time the shutter remains open, also determines the amount of light allowed to strike the film. The Nikon F3AF offers automatic stepless shutter speed control over the range from 1/2000 sec. to 8 sec., plus full manual control with a choice of 18 settings, including B, T, and X. All shutter speeds, except T, are electromagnetically controlled.



The shutter speed dial 72 has the following settings:

A (Auto): Provides aperture-priority automatic exposure control in which you first select the shooting aperture, then the camera sets the corresponding shutter speed for correct exposure.

1/2000~8 sec.: 15 discrete settings give you full manual control of the shutter speed. The numbers engraved on the dial in white are reciprocals, for example 2000 means 1/2000 sec. 60, also a reciprocal, appears in red and indicates the highest manual shutter speed for proper synchronization with electronic flash (with the exception of X). Numbers engraved in orange represent actual shutter speeds, for example an orange 8 means 8 sec.

B (Bulb): The shutter remains open as long as the shutter release button 73 is depressed.



T (Time): At this mechanical setting, the shutter stays open until the dial is rotated to another setting, making it ideal for really long time exposure. To avoid unnecessary battery drain, follow this procedure: turn the power switch 74 off and make certain the LCD is not displayed in the finder, then trip the shutter using the backup mechanical release lever 6.

X (X-sync): Provides 1/80 sec. speed, the proper synchronization speed for any electronic flash unit.

To set the shutter speed dial, rotate it until the desired setting click-stops opposite the index line 10; the dial is locked at the A and X settings to prevent accidental shifting of the setting. To move the dial off a locked setting, push the locking button 77 as you rotate the dial. Intermediate settings should not be used.

EXPOSURE—continued

+2000, 2000, 1000, 500, 250, 125, 60, 30, 15, 8, 4, 2, 1, 2⁻, 4⁻, 8⁻, -8⁻, 80

With one of these indications displayed, correct exposure will be obtained.

+2000 indicates that the subject is too bright for the working aperture you have chosen; to remedy this situation, use a smaller aperture. If the correct exposure is still unobtainable even at the smallest aperture, use an ND (neutral density) filter.

-8- indicates the subject is too dark and you should use a larger aperture. If the correct exposure is unobtainable even at maximum aperture, use an electronic flash or other supplementary illumination.

When making blank exposures with the shutter speed dial set at A or 1/125 sec. or above, an 80 will appear until you reach frame one.

Automatic Exposure Control

Automatic exposure is the most convenient way to shoot with the Nikon F3AF, because it allows you to concentrate fully on the subject without worrying about the exposure. By presetting the aperture and locking the shutter speed dial π at A, the camera automatically sets the proper stepless shutter speed from 1/2000 to 8 sec. as soon as the shutter release button π is depressed halfway. To keep you fully informed, the shutter speed is displayed via LCD in the viewfinder. Speeds between 1/2 and 1/2000 sec. are shown as a reciprocal of the actual speed, for example 125 means 1/125 sec. Speeds between 1 and 8 seconds are signified by a - symbol appearing to the upper right of the number, for example 8⁻ means 8 sec. To make

the display easy to read, intermediate speeds appear in the display as a discrete shutter speed which is closest to the actual speed. (For instance, 1/287 sec. might be the automatically selected shutter speed in use, but 250 will be displayed.) The LCD stays on for approx. 16 sec. after you remove your finger from the shutter button.

Before shooting, check the exposure display.

Note: The camera's effective metering range depends on the shutter speed and aperture in use at a particular film speed. Please refer to pp. 66-69 for more information.

M 500 Underexposure

Use a larger aperture or slower shutter speed.

M + 125 Overexposure

Use a smaller aperture or faster shutter speed.

M + 250 Correct exposure

Within $\pm 1/4$ EV.

M - B (BULB)

M - T (TIME)

M + 80 X (X-SYNC)

Manual Exposure Control

In the manual exposure mode, you can shoot at any combination of f/stop and shutter speed from 1/2000 to 8 sec., enabling you to select your desired shutter speed. Manual exposure is also required when stop-down exposure measurement is necessary or when you want to use the B, T, or X setting.

Except at the B, T, and X settings, the shutter speed you set is shown in the viewfinder immediately after the shutter release button Ⓢ is depressed halfway. As before, the - symbol at the upper right of the number indicates shutter speeds from 1 to 8 sec. Also the letter M appears to the left of the number, indicating the manual exposure mode. Above the M, the following symbols appear: -, +, and -+ which indicate underexposure, overexposure, and correct exposure, respectively. To obtain correct exposure, simply turn the shutter speed dial Ⓢ and/or aperture ring until the -+ symbol appears. The LCD stays on approx. 16 sec. after you remove your finger from the button.

Intermediate settings on the shutter speed dial cannot be used while those on the lens aperture ring Ⓢ can be. Therefore, stop the lens aperture down or open it up to the appropriate intermediate setting when fine adjustment of the exposure is necessary.

When making blank exposures with the shutter speed dial set between 1/125 and 1/2000 sec., the shutter fires at 1/80 sec. with M 80 displayed until the frame counter reaches one.

At the B or T setting, an M- appears in the viewfinder.

At X, an M+ 80 appears. However, the + does not mean overexposure, because the meter does not function at this setting; as soon as a dedicated Nikon Speedlight is attached to the F3AF and turned on, the + disappears from the display, leaving just M 80.

EXPOSURE—continued

Shutter speed (sec.)	1/2000	1/1000	1/500	1/250	1/125	1/60
Aperture (f-number)	2.8	4	5.6	8	11	16

Relationship Between Shutter Speed and Aperture

The amount of light reaching the film plane is determined by a combination of the shutter speed and the lens aperture. A shutter speed of 1/125 sec. lets in twice as much light as a setting of 1/250 sec. and only half as much light as 1/60 sec. An aperture setting of f/11 lets in twice as much light as f/16, half as much as f/8. Thus, if the correct exposure for a particular picture-taking situation is 1/125 at f/11, then 1/250 at f/8 or 1/60 at f/16 will give the same exposure.

The table above illustrates the interrelationship between shutter speed and aperture.

The best combination will depend on the results you want. Use fast shutter speeds to freeze motion; use slow speeds to produce a deliberate blur. Also, small apertures give greater depth of field, while large apertures restrict the zone of sharp focus to the main subject. (For more detailed information about depth of field, refer to page 36.)

A good rule to follow in preventing camera shake is to select a minimum shutter speed which is the reciprocal of the focal length of the lens in use. For example, when using a normal 50 mm lens, select a speed no slower than 1/60 sec. (the closest number to 1/50). For a 200 mm super-telephoto, use no less than 1/250 sec. and so forth.



A fast shutter speed freezes the rider and background.



By panning the camera, a slow one allows the background to blur.

EXPOSURE—continued

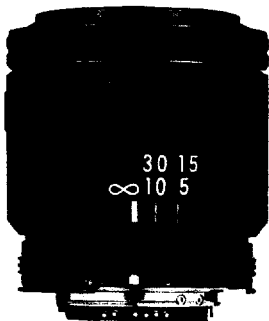

Depth of Field

When you shoot at a certain aperture and focusing distance, you will find that not only the main subject but objects in a certain distance range in front of and behind it will be sharp in the final photograph. Objects beyond this range become increasingly out of focus. This "in-focus zone" is known as depth of field. When this zone of sharpness is large, the depth of field is said to be deep; when it is small, the depth of field is said to be shallow.

The following is true of depth of field:

- 1) The smaller the shooting aperture (i.e. the larger the numerical f-number), the deeper the depth of field; the larger the aperture, the shallower the depth of field.
- 2) The farther away the subject is from the lens, the deeper the depth of field becomes; the closer to the lens, the shallower the depth of field.

- 3) The longer the focal length of a lens, the shallower the depth of field at each f/stop; the shorter the focal length, the deeper the depth of field.

- 4) There is greater depth of field behind the main subject than in front of it.

The depth of field at each aperture is indicated on the lens by a set of color-coded lines (corresponding to the colors of the f-numbers on the aperture ring) which are used in conjunction with the distance scale. The range is indicated by the distance between the lines.

Note: Certain Zoom-Nikkor and special-purpose Nikkor lenses do not have a depth-of-field scale.

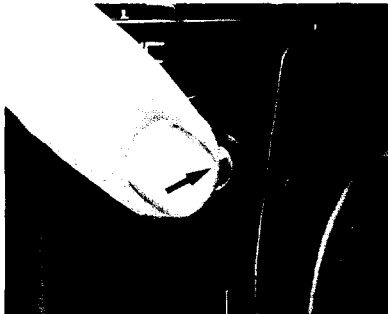

Depth-of-field preview button ③

When a lens with an automatic diaphragm is used, the image in the viewfinder is viewed with the lens at maximum aperture. However, by depressing the depth-of-field preview button, the lens will be stopped down to the aperture set, enabling you to examine depth of field before shooting. The image in the viewfinder darkens according to the selected f-number: the smaller the aperture (i.e., the larger f-number), the darker the image. Components of the picture that appear in focus when the button is depressed will be in the zone of sharp focus.

Note that the button should be depressed all the way.

Note: When shooting in the automatic exposure mode with an AI lens, do not release the shutter while depressing the preview button; improper exposure may result.

To illustrate depth of field, the following photos were taken with the AF-Nikkor 80mm f/2.8 lens at a focused distance of 5 m; the only difference is that they were shot at various apertures. Control of depth of field enables you to create photos having selective focus (where the major subject stands out from the background and/or foreground) or overall sharpness (in which all elements in the picture appear sharp). Depth of field imparts to your picture a character all its own.

EXPOSURE—continued



Lens set at f/2.8



Lens set at f/16

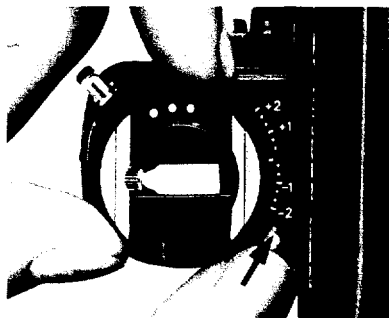

Suggested Applications for Exposure Compensation

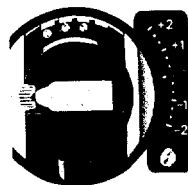

- +2 White background, snow scene
- +1 White background occupying half of viewing area
- -1 spotlighted subject, black background occupying half of viewing area
- -2 black background

Exposure Compensation

In the vast majority of cases, the F3AF provides the correct exposure on automatic. However, certain situations require a deviation from the automatic exposure setting. For this purpose, the F3AF features both an exposure compensation dial α and a memory lock button β .

Exposure compensation dial

This dial adjusts the exposure by increasing or decreasing the automatically selected shutter speed. When the scene is unusually light or dark in tone (e.g., a snow scene), exposure compensation must be made to prevent over- or underexposure. Or under normal conditions, you can intentionally over- or underexpose the shot to create special "high-key" or "low-key" effects.

To make exposure compensation, push the locking button β as you rotate the exposure compensation dial. It is graduated in one-third stop increments: -1 and -2 indicate one and two stops less exposure, whereas $+1$ and $+2$ indicate one and two stops additional exposure. At ASA/ISO 6400, the compensation extends to only -1 ; at ASA/ISO 12, up to $+1$. After use make sure to reset the dial to "0."

The recommended exposure compensation settings for various subjects and picture-taking situations are shown above.

Note: Because the LCD shows only discrete shutter speeds, a slight adjustment of the exposure compensation dial, such as $+1/3$, may not be reflected in a change in shutter speed.

EXPOSURE—continued

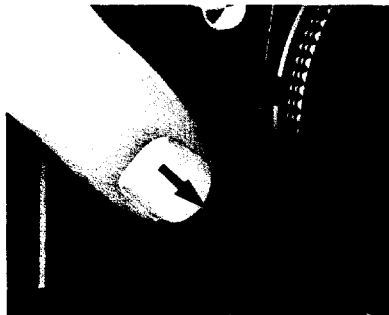

Memory lock button

Another way of making exposure compensation with the F3AF on automatic is to use the exposure memory lock button. When there is a substantial difference in brightness between the main subject and the background, such as a strongly backlit subject, the camera's exposure meter is likely to be fooled, resulting in under- or overexposure (Fig. 1). To compensate for this, center the main subject in the viewfinder or move in close to the subject, depress the memory lock button and hold it in; then recompose and shoot (Fig. 2).

Note: In autofocus operation, you must also depress the focus lock button when recomposing with the subject off-center to keep it in sharp focus.

250 5.6



5.0 5.6

5.0 5.6



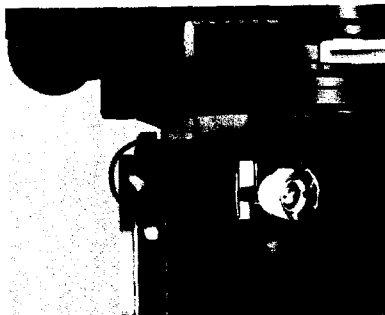
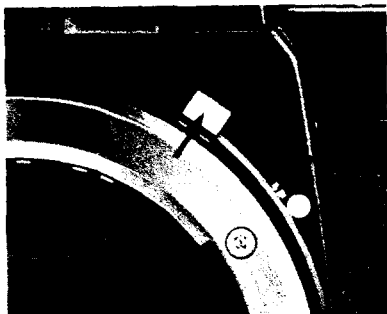

Stop-Down Exposure Measurement

When using a non-AI lens or certain close-up accessories, you must push the meter coupling lever release button ③ and lock the meter coupling lever ④ in the "up" position before mounting a lens or attaching an accessory. In this case, the diaphragm in the lens does not link with the meter coupling lever on the camera body. Therefore, you must perform stop-down metering. The procedure is as follows:

For non-AI lenses with automatic diaphragms

On auto: Push the depth-of-field preview button ③ all the way in and hold it as you trip the shutter.

Caution: If the depth-of-field preview button is not depressed all the way, the mirror ⑤ may remain in the "up" position.

On manual: Select a shutter speed. Then hold in the preview button and turn the lens aperture ring ⑥ until the - + symbol appears in the viewfinder. Release the preview button and take the shot.

For non-AI lenses or accessories without automatic diaphragms

On auto: Stop the lens down manually until the desired shutter speed appears in the viewfinder. Then take the picture.

On manual: Adjust the shutter speed or aperture until the - + sign appears.

For fixed-aperture lenses, photomicrography, or astrophotography

On auto: No control is necessary; just take the picture.

On manual: Adjust the shutter speed dial until the - + appears. If correct exposure is unobtainable, use an ND (neutral density) filter or change the illumination to adjust the exposure.

OTHER CONTROLS

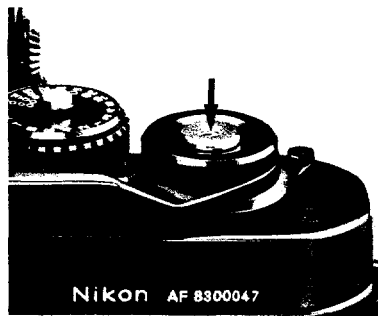

Shutter Release Button ⁷⁵

Depressing the button halfway switches on the exposure meter and autofocus function and activates the viewfinder LED and LCD displays for focus/exposure information. Both displays stay on for approx. 16 sec., even after taking your finger off the button, then turn themselves off automatically to conserve battery power. Depressing the button all the way down releases the shutter. The shutter release button is threaded in its center to accept a standard cable release for tripping the shutter with the camera mounted on a tripod.

Notes:

- 1) The shutter cannot be tripped using the shutter release button unless:
a) the camera's power switch ⁷⁸ is turned on, b) the film advance lever ⁷⁹ is stroked completely to cock the shutter, and c) the batteries are in proper working order. To release the shutter when the batteries are dead, use the backup mechanical release lever ⁶, referring to the next page.
- 2) At the B setting, unless you hold the shutter release button down all the way, the shutter may close prematurely.
- 3) Do not screw a tripod into the camera's tripod socket ⁴⁴ too tightly.



Backup Mechanical Release Lever ⁶

This lever is provided as an alternative method of releasing the shutter in case the camera's batteries become weak or completely exhausted. To operate the lever, first use your fingernail to pull it down to the ready position. Then push it down to trip the shutter. The shutter operates at a mechanical speed of approx. 1/60 sec. at any setting on the shutter speed dial, except T. At T, push down the backup mechanical release lever with the power switch ⁷⁸ off.

Caution: If you advance the film while holding down the backup mechanical release lever, the shutter will fire immediately at the completion of the film advance stroke, thus wasting a frame. Also, if you fail to advance the film completely and then use the lever to trip the shutter, the mirror ¹⁹ will remain in the "up" position; when the additional stroke is made to complete film winding, the shutter will fire, also wasting a frame.

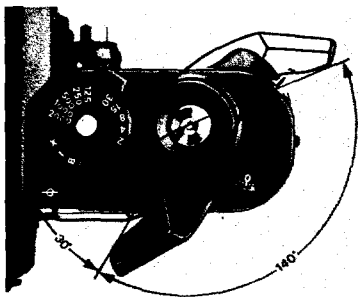

Film Advance Lever ³³

The film advance lever is coaxial with the shutter release button  and is specially contoured to fit the thumb. To advance the film, wind the lever to the right all the way until it stops. It automatically returns to the standoff position the moment you take your thumb off it. One complete stroke or a series of shorter ones advances the film by a single frame and simultaneously cocks the shutter.

At the end of the film roll, the lever stops working. Do not attempt to wind the lever further; just rewind the film.

Note: If the lever becomes difficult to operate at the beginning of the roll, this means that the film is not winding onto the takeup spool  properly. In this case, rewind the film immediately and load the film again.



Frame Counter ⁷⁶

To keep track of the number of exposed frames, the frame counter is graduated from two frames below 0 up to 40. Blue numerals appear every 5 frames (0, 5, 10, etc.), with dots in between. White marks at 12, 20, 24, and 36 indicate the number of frames available on most film cartridges. When making blank shots with the shutter speed dial  set to "A," the shutter will fire at 1/80 sec. until the frame counter reaches the first frame. In addition, the LCD shows 80 in the finder. Or, if you set the dial manually between 1/125 and 1/2000 sec., the shutter will still fire at 1/80 sec. In the finder, an M 80 is displayed. However, if the speed is manually set to 1/80 sec. (X) or below, the shutter will fire at the speed set with the LCD indicating that speed. Therefore, to speed up film loading, set the dial to A or to 1/125 sec. or above.

When the camera back  is opened, the frame counter automatically resets to two frames below zero.

OTHER CONTROLS—continued

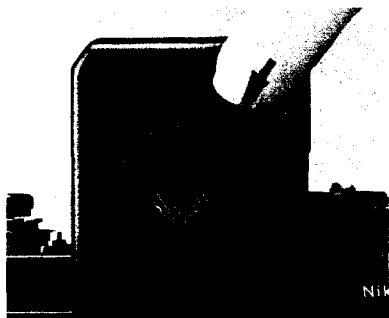

Eyepiece Shutter Lever ³⁸

When it is impossible to keep your eye at the viewfinder (such as when utilizing the self-timer), you should use the eyepiece shutter. This shutter prevents stray light from entering the eyepiece and adversely affecting the automatic exposure meter reading and autofocus function. Just push the lever to the left to close the shutter. As a visual reminder that it is in use, the blind is painted red.

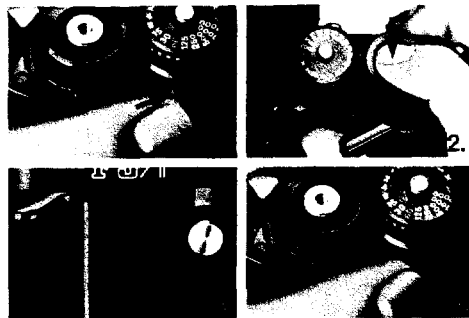

Self-Timer

The F3AF's blinking self-timer provides a 10-sec. delay in shutter release. To operate the self-timer, push the self-timer lever ^A to uncover the red dot (Fig. 1). (When using the camera in the autofocus and/or automatic exposure modes, don't forget to close the eyepiece shutter to prevent stray light from entering the eyepiece.) Then push the shutter release button ^B (Fig. 2). Immediately the red LED ^C on the front of the camera will start blinking and then speed up during the final two seconds before the shutter opens to warn you to get ready (Fig. 3). Finally, return the self-timer lever to its original position after use (Fig. 4). If you want to cancel the self-timer after pushing the shutter release button, return the self-timer lever to its original position. This will prevent the picture from being taken.

Note: The B setting on the shutter speed dial ^D does not function as B with the self-timer.



Mirror Lockup Lever ⁴

In the following situations, the F3AF's mirror ¹⁹ must be locked in the "up" position: when you want to operate the Motor Drive MD-4 at 6 frames per second or when using certain fisheye lenses which do not feature through-the-lens viewing. Also, when using super-telephoto lenses or doing photomicrography, it becomes necessary to minimize camera vibration. To lock the reflex viewing mirror in the "up" position, push in the depth-of-field preview button ³ and rotate the lever counterclockwise until it stops. To return the mirror to the "down" position, rotate the lever clockwise until it stops.

Do not release the shutter unless the mirror is completely in the "up" or "down" position.

Caution: With the mirror locked up, you should not operate the camera on automatic. Even though the LCD continues to show you the shutter speed automatically selected by the camera, this speed will not produce the correct exposure. Autofocus operation with the mirror in the "up" position is also impossible.



Viewfinder Illuminator ¹³

A convenient built-in viewfinder illuminator lets you see the LCD exposure information and the aperture, even in dim light. To turn on the illuminator, push the red illuminator button ¹¹ located at the base of the viewfinder just in front of the shutter speed dial ⁷². Please remember that the illuminator only lights up when the camera's exposure meter is switched on, but turns off as soon as you remove your finger from the button.

Notes:

- 1) If you plan to use the illuminator for extended periods, take along a spare set of fresh batteries for the camera body, because the illuminator consumes a lot of power.
- 2) At low temperatures or with nearly exhausted batteries, using the illuminator might temporarily lower the voltage, causing the LCD to disappear. If the LCD appears again when the illuminator is off, you can release the shutter without replacing the batteries.

OTHER CONTROLS—continued

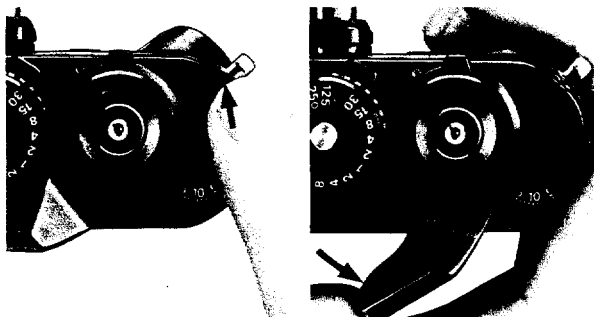

Multiple Exposure Lever ⁷⁴

For creative and unusual effects, the F3AF allows you to record more than one image on the same frame of film. To make double or multiple exposures, follow this procedure:

- 1) Take the first shot.
- 2) Then to recock the shutter without advancing the film, push the multiple exposure lever forward (Fig. 1), and stroke the advance lever ³⁹. Immediately the multiple exposure lever will spring back to its normal position (Fig. 2).
- 3) Now you are ready to take the second shot on the same frame. For more than two shots on the same frame, just repeat the same procedure for each additional exposure. When you have finished, simply advance the film normally to the next frame. While making multiple exposures, the frame counter does not advance. The multiple exposure setting cannot be cancelled once the lever is set in the "out" position.

Note: If you wish to cancel the multiple exposure setting, first cover the lens with the lens cap and close the eyepiece shutter; then make a blank shot and advance the film to the next frame.

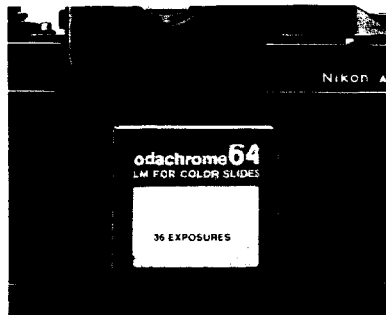

Memo Holder ³⁷

As a reminder of the film type and the number of exposures on the roll in use, clip off the end of the film carton and insert it into the memo holder. While loading the film, insert the film carton end before closing the camera back. When film is already loaded, you must remove the DX-1 finder.

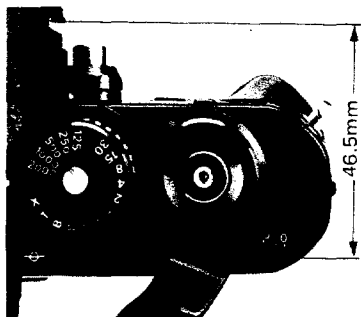

Film Plane Indicator ⁷⁸

The film plane indicator (↔) is engraved in white on the top deck just behind the shutter speed dial. It indicates the exact position of the film plane inside the camera. Whenever it becomes necessary to measure the exact distance between the subject and film plane, such as in macrophotography, use the film plane indicator. The distance between the film plane and the lens mounting flange is exactly 46.5mm.

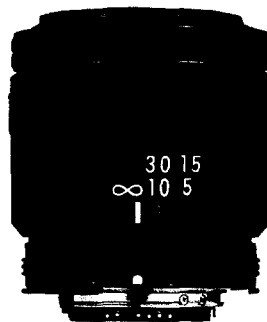

Infrared Focusing Index

The red dot beside the focusing index on most lenses is the infrared focusing index. When shooting with black-and-white (but not color) infrared film, it is necessary to refocus the lens to compensate for the fact that infrared light rays focus at a point slightly in front of visible light.

In infrared photography, use of the R60 filter is required. At first, focus on your subject through the viewfinder by rotating the lens focusing ring (⊕) without the filter in place. Then look at the lens and take note of the focused distance. Reset the focusing ring so that the desired distance is aligned with the red dot. Finally take pictures with the filter attached.

Note: Automatic focusing is impossible in black-and-white infrared photography.

FLASH PHOTOGRAPHY

The Nikon F3AF has been specially designed to make electronic flash photography easier than ever. When used with an accessory Nikon dedicated flash unit, the camera offers fully automatic through-the-lens (TTL) control of the flash exposure. This means that while the shutter is open, the camera's silicon photodiode (SPD) reads the light reflected directly off the film and tells the flash unit to cut itself off when the exposure is correct.

To prevent mistakes, the camera also offers automatic switch-over of the shutter speed for proper synchronization. With the shutter speed dial \overline{A} set at A or 1/125 sec. or above, the shutter speed is automatically switched to 1/80 sec. as soon as the flash is turned on. As a reminder, the LCD shows 80 on auto or M 80 on manual. For creative fill-in flash effects, you can set the speed manually to 1/60 sec. or below and the shutter fires at the speed set with the speed in use displayed in the viewfinder.

For non-dedicated flash units, an X setting is provided, giving you the proper manual speed of 1/80 sec. At X, M* 80 appears in the LCD. However, if you use a Nikon dedicated flash unit at this setting, M 80 appears as soon as the unit is turned on.

When shooting manually with any flash unit, it is necessary to determine the flash unit's guide number for the film you are using; then set the aperture to match the shooting distance.



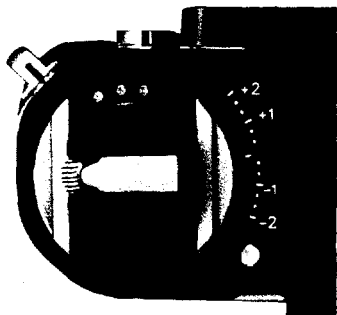

Accessory Shoe ⁵⁹

Located at the base of the rewind knob , the accessory shoe allows direct mounting of a Nikon dedicated flash unit, such as the SB-12, SB-16A or SB-17. To mount other direct-mounting flash units (having either an ISO- or Nikon F2-type mounting foot) to the F3AF's accessory shoe, a Nikon Flash Unit Coupler is required (for details, refer to page 56.) The accessory shoe also accepts accessory cords, such as the SC-12 and SC-13, for convenient flash photography with Nikon bracket-mounting units, such as the SB-11 and 14.

Three electrical contacts  on the accessory shoe provide for synchronization of the flash unit, automatic TTL output control, and ready-light indication (via an LED) in the camera's viewfinder, plus auto switching to the proper synchronization speed of 1/80sec.

Caution: For flash photography, it is recommended that you use a Nikon dedicated electronic flash unit which operates with a low-voltage current. The use of any other flash which operates at high voltages may damage the camera's circuitry; any damage caused by such use is not covered by the Nikon Warranty.

FLASH PHOTOGRAPHY—continued

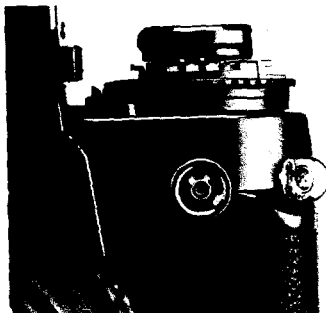

Sync Terminal ¹⁶

A separate sync terminal with a protective screw-in cover is provided on the Nikon F3AF. When using flashbulbs or an electronic flash unit without a hot-shoe contact, it is necessary to use the camera's sync terminal. It accepts all standard plug-in PC cords, plus it is threaded for use with a Nikon screw-in PC cord.

The F3AF features an X-sync contact only, allowing electronic flash units to be synchronized at a speed of 1/80 sec. (X) or slower.

		Shutter speed (sec.)																
		1/2000	1/1000	1/500	1/250	1/125	1/60	1/30	1/15	1/8	1/4	1/2	1	2	4	8	X (1/80)	B
Speedlight																		
Flashbulb	FP																	
	M																	
	MF																	

Synchronized

Cannot be used

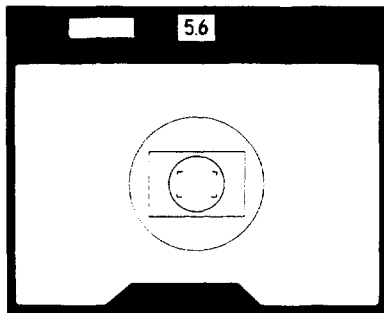

Ready-Light

A built-in LED ready-light is provided in the upper right-hand portion of the viewfinder outside the picture area. When a Nikon dedicated flash unit (or a TTL sensor cord) is attached to the accessory shoe , the ready-light comes on as soon as the flash is recycled, indicating that the unit is ready to fire. So, you never have to remove your eye from the viewfinder. Moreover, in the TTL mode, whenever the flash unit fires at its maximum output, the ready-light starts blinking for approx. two seconds, warning you that the light was probably insufficient for correct exposure. As an additional warning, it blinks if the flash is not connected properly or if the ASA/ISO setting on the camera is outside the dedicated flash unit's range of ASA/ISO 25~400. For more detailed information, refer to the flash unit's instruction manual.

Nikon F3AF/Speedlight Combination Chart

Speedlight	Camera's ready-light	Shutter speed auto changeover	Usable flash output control
SB-17	yes	yes	TTL, auto, manual, MD
SB-16A	yes	yes	TTL, auto, manual, MD
SB-12*	yes	yes	TTL, manual
SB-11/14	(with SC-12)	yes	TTL, manual
	(with SC-13)	yes	auto, manual
	(with SC-11)	no	auto, manual
SB-19** (with AS-4, 7)	yes	yes	auto only
SB-18** (with AS-4, 7)	yes	yes	manual only
SB-15 (with AS-4, 7)*	yes	yes	auto, manual, MD
SB-10 (with AS-4, 7)	yes	yes	auto, manual
SB-7E (with AS-3)	no	no	auto, manual
SB-6	(with SC-6)	no	manual, MD
	(with AS-3, SC-9, SU-1)	no	auto, manual, MD
SB-E** (with AS-4, 7)	yes	yes	auto only

* With the SB-12 or SB-15 mounted on the Nikon F3AF, the flash head cannot be rotated so that it is over the AF Finder DX-1.

** The SB-19, SB-18 and SB-E cannot be mounted on the F3AF unless the Eyelevel Finder DE-2 or High-Eyepoint Finder DE-3 is used.

ACCESSORIES

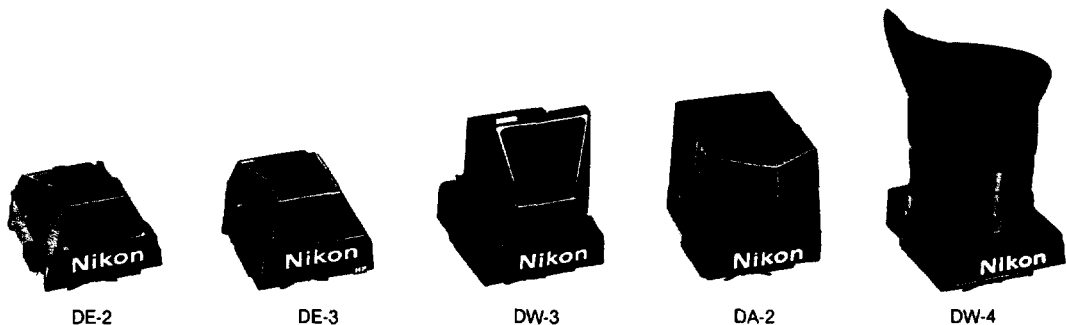

Interchangeable Viewfinders

In addition to the AF Finder DX-1, the F3AF camera also accepts other interchangeable viewfinders designed for the regular Nikon F3. With them, all Nikkor and Nikon Series E lenses, including the AF-Nikkors, are usable with the F3AF body. Regardless of which finder is attached, you still have full automatic exposure control because the meter is built into the camera body rather than the finder. The camera's autofocus control, however, cannot be used with viewfinders other than the DX-1. The Eyelevel Finder DE-2 offers regular eyelevel viewing and provides an upright and unreversed image in the viewfinder. The High-Eyepoint Finder DE-3 gives you the same eyelevel viewing, but allows eyeglass wearers and action photographers alike to

see the entire frame with the eye up to approx. 25mm away from the eyepiece. The Waist-Level Finder DW-3 is ideal when you want to use the camera at a low angle or upside down over your head for shooting over crowds. The Action Finder DA-2 works well for those situations when you cannot bring your eye close to the finder, such as in fast-breaking sports events, when you are wearing a helmet or goggles, or when the camera is enclosed in waterproof underwater housing. The 6X Magnification Finder DW-4 is for critical high-magnification close-up work or photomicrography.

When using the DA-2 or DW-3, be careful that stray light does not enter from the top and cause an inflated meter reading.



To remove the finder, use your thumb and forefinger to slide the finder release levers  toward the back of the camera; then lift the finder out. Before attaching another viewfinder, a focusing screen must be installed (please refer to page 54). To attach the new finder, position it above the camera with the nameplate facing toward the front of the camera, and gently push the viewfinder down until it is fully seated in place. Make sure the finder is attached securely.

Do not forget to remove the focusing screen from the body when you reattach the AF Finder DX-1. If not, both the focusing screen inside the camera body and the one built into the bottom of the DX-1 might be damaged.

Caution:

- 1) *When handling the F3AF with the DX-1 removed, be careful not to soil or damage the electrical contacts at the bottom of the finder or the matching ones inside the camera body at the top of the mirror box. Also do not short-circuit them.*
- 2) *Do not pick up the camera by the finder only. The force may cause damage to the camera.*
- 3) *To prevent dirt from getting inside the finder, always keep the eyepiece glass attached.*
- 4) *When storing the DX-1 separately from the camera body, attach the protective cover (supplied with the camera) to prevent the built-in finder screen from becoming scratched.*

ACCESSORIES—continued

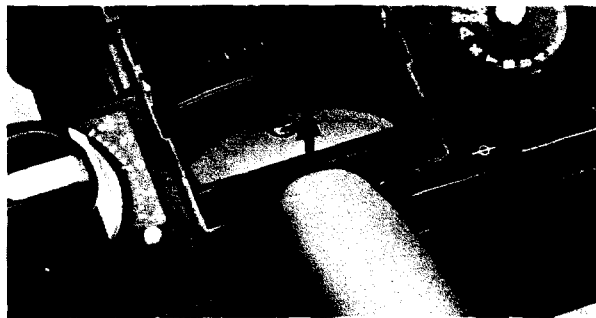
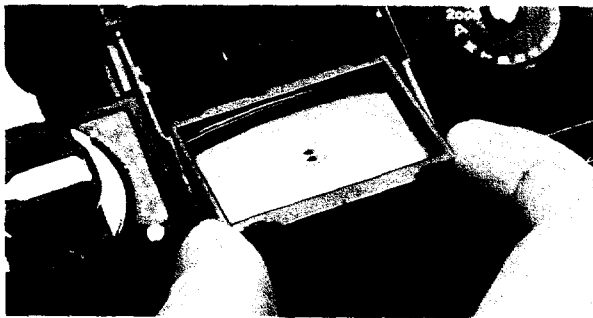

Focusing Screens

When using a viewfinder other than the standard AF Finder DX-1, you have a choice of 21 interchangeable focusing screens, as listed on the next page. To install a focusing screen, simply insert the front edge (the edge with the slot in the middle) under the pin and push the rear edge of the screen down into place. To take out the focusing screen, first remove the finder, then insert your fingernail under the rear edge of the screen and lift it out.

Note: For more information on which screens are compatible with which lenses, consult the instruction manual supplied with the lens.

Focusing Screen Selector Guide

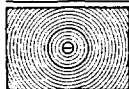

Type A: Matte/Fresnel field with 3mm ϕ circular split-image rangefinder spot and 12mm ϕ reference circle. Rapid and accurate focusing. Excellent for general photography.

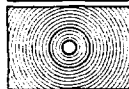

Type B: Matte/Fresnel field with 3mm ϕ fine-ground matte focusing spot and 12mm ϕ reference circle. Good for general photography, especially with long lenses.



Type C: Fine-ground matte field with 4mm ϕ clear spot and cross hair. For photomicrography, astrophotography and other high-magnification applications, using parallax focusing on aerial images.



Type D: Overall fine-ground matte field. For specialized close-up photography and for use with long lenses.

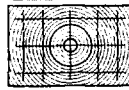

Type E: Matte/Fresnel field with 3mm ϕ fine-ground matte spot, 12mm ϕ reference circle, and etched horizontal and vertical lines. Ideal for architectural photography.



Type G: Clear Fresnel field with extra-bright 12mm ϕ microprism focusing spot for viewing and focusing in poor light. Four models (G1 - G4) are available corresponding to specific focal length lenses. Depth of field cannot be observed.



Type H: Clear Fresnel field with microprism focusing pattern over the entire screen area. Permits rapid focusing on any part of the screen with optimum edge-to-edge brightness in poor light. Available in four models (H1 - H4) corresponding to particular focal length lenses.

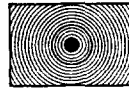

Type J: Matte/Fresnel field with central microprism focusing spot and 12mm ϕ circle. Good for general photography.



Type K: Combination of Type A and J screens. Matte/Fresnel field with 3mm ϕ split-image rangefinder spot surrounded by 1mm-wide microprism doughnut. Rapid and accurate focusing for subjects with both straight lines and ill-defined contours. Suitable for general photography.

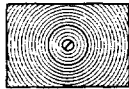

Type L: Same as Type A screen but with split-image rangefinder line at a 45 $^\circ$ angle. Best for subjects with horizontal lines.

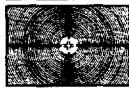

Type M: Fine-ground Fresnel field with 5.5mm ϕ clear spot and double cross hair for use in parallax focusing on aerial image, plus millimeter scales for calculation of individual magnification of objects or for measuring objects. Brilliant image in dim light. Suitable for close-ups, photomicrography and other high-magnification applications.

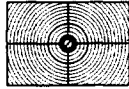

Type P: Same as Type K but with split-image rangefinder line at a 45 $^\circ$ angle and etched horizontal and vertical lines as an aid to composition. Rapid and accurate focusing for subject with horizontal or vertical lines or ill-defined contours. Suitable for general photography.

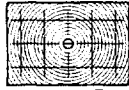

Type R: Same as Type A but with rangefinder prisms of sloping surfaces at a smaller angle and horizontal and vertical lines to aid proper composition. Works best with lenses having maximum apertures from 1/3.5 to 1/5.6.

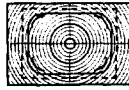

Type T: Matte/Fresnel field with split-image rangefinder, 12mm ϕ reference circle, and horizontal and vertical lines. Used when preparing slides for TV broadcasts. Dotted lines indicate standard TV screen format. Solid outline shows "safe action" area, whereas broken lines indicate "safe title" area.

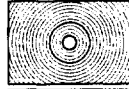

Type U: Matte/Fresnel field with 3mm ϕ fine-ground matte focusing spot and 12mm ϕ reference circle. Utilizes the same matte field as Type B, but with lenses longer than 100mm the image in the viewfinder is easier to see. With shorter focal-length lenses, this screen is not suitable because of light fall-off in the corner.

ACCESSORIES—continued

Electronic Flash Equipment

Indispensable for shooting in dim light and at night or for filling in the shadows in daylight, Nikon Speedlights are dedicated electronic flash units which complement your Nikon F3AF perfectly. Everything about these Speedlights is automatic—all you have to do is set the aperture and the flash output is measured through the lens, ensuring the correct exposure regardless of the lens in use.

Speedlights SB-12, SB-16A and SB-17

Compact and light, Nikon SB-12, SB-16A and SB-17 mount directly on the camera to provide automatic TTL control of the flash exposure. The SB-12 has a guide number of 25 (ASA/ISO 100 and meters) or 41 (ASA/ISO 25 and feet). The SB-16A features a zoom head with four zoom settings for 28, 35, 50 and 85mm lenses with a guide number of 32 (ASA/ISO 100 and meters) or 52 (ASA/ISO 25 and feet) for the 35mm setting. For bounce flash, it has two flash heads: the main head not only tilts back 90° but rotates 270°, while the smaller secondary head faces straight ahead to provide a catchlight for the eyes. Similar in size and power rating to the SB-12, the SB-17 employs a tilting flashtube module for convenient bounce flash.



F3AF with SB-12

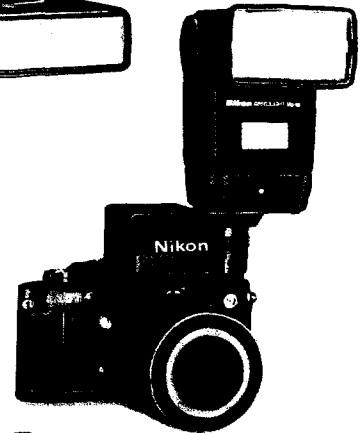

F3AF with SB-16A

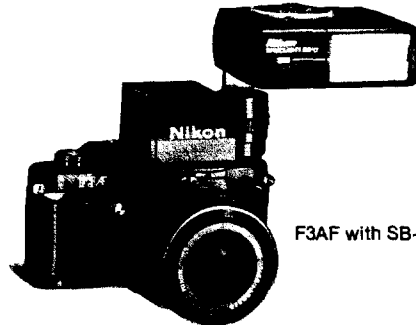

F3AF with SB-17

Speedlights SB-11 and 14

For those photographers requiring a separate bracket-mounting unit, Nikon has the SB-11 and SB-14. The guide number of the SB-11 is 36 (ASA/ISO 100 and meters) or 60 (ASA/ISO 25 and feet), while the SB-14, which requires a separate battery pack, has a guide number of 32 (ASA/ISO 100 and meters) or 52 (ASA/ISO 25 and feet). For automatic TTL control, these units must be used with the TTL Sensor Cord SC-12. Featuring tilting flash heads, the SB-11 and 14 allow you to bounce the light easily off the ceiling or walls for softer, more flattering lighting for portraits.

Flash Unit Couplers AS-3, 4, and 7

To mount other direct mounting flash units on the F3AF's accessory shoe, a Nikon Flash Unit Coupler is required. The AS-3 coupler is necessary when mounting the Nikon SB-7, while the AS-4 or AS-7 is for the SB-15, SB-E, or SB-10. A special feature of the AS-7 is that it lets you change film without removing the flash unit.



AS-3



AS-4

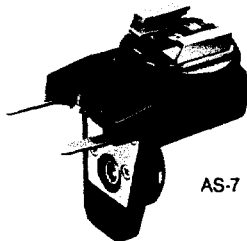

AS-7

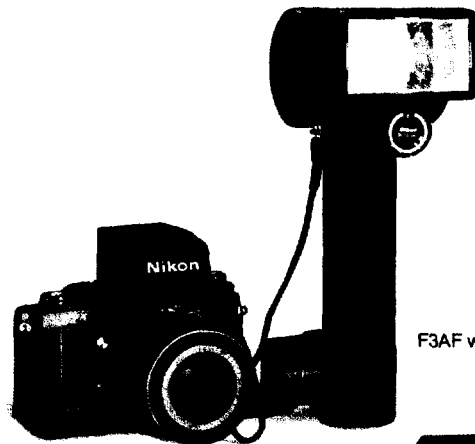

F3AF with SB-11

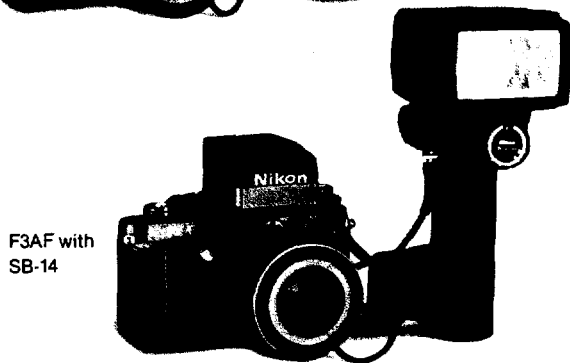

F3AF with
SB-14

ACCESSORIES—continued

Motor Drive MD-4

One of the most exciting accessories for the F3AF camera is the Motor Drive MD-4. This amazingly compact, light, and streamlined unit attaches to the bottom of the camera in seconds and advances the film either singly or in sequence up to 6* frames per second—making it the fastest regular production motor drive on the market today. Actual controls have been reduced to only those necessary for convenient operation. In addition to the electromagnetic trigger button (which also turns on the camera's meter when depressed halfway), there are its concentric S-C (Single/Continuous) mode selector, a battery check button and LED indicators, two interlocking rewind slides for automatic film rewinding, and a subtractive frame counter which stops the motor at the desired number of frames. Eight AA-type penlight batteries fit into a quick-release clip housed in the base of the motor drive. An optional NiCd battery pack is available for use in cold weather or when you want the fastest possible firing rate. Once you attach the MD-4 to your camera, you'll never want to take it off.

The Firing Rate Converter MK-1 is available as a special accessory for a motor-driven F3AF. It screws into the tripod socket of the MD-4 and plugs into the remote terminal to provide three firing rates—1, 2, or 3 frames per second—allowing you to operate the motor drive on continuous while the camera focuses automatically. It has its own handy trigger button for use in vertical-format shooting.

The Magazine Back MF-4 for shooting up to 250 frames without changing film is also available as an option.

* Possible with NiCd battery pack at 1/125 sec. or above with the mirror locked up.



F3AF with MD-4



MK-1

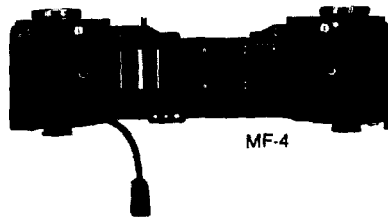

MF-4

Data Back MF-14

To keep track of when photos were taken, the F3AF accepts the Data Back MF-14 which slips on in place of the regular camera back with no sync cord needed. Three imprinting modes are possible: year/month/day, day/hour/minute, or picture counting; information is displayed clearly on the data back via an LCD and then is imprinted on the film at the instant of exposure. Serving as a handy clock, a quartz timer with an alarm function is also incorporated.

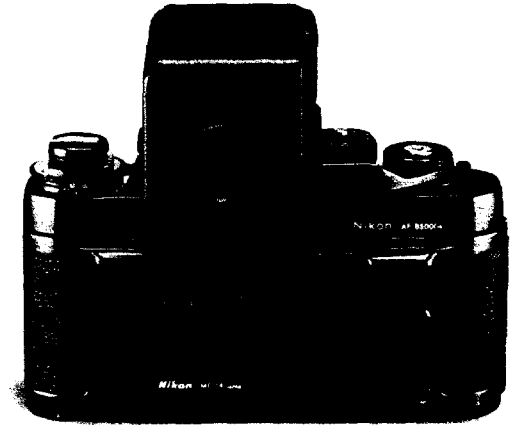

ACCESSORIES—continued

Close-Up Equipment

For shooting subjects which are located closer than the closest possible focusing distance of the lens, Nikon makes a wide variety of equipment:

- 1) Close-Up Attachment Lenses Nos. 0, 1, 2, 3T, 4T, 5T, and 6T.
These lenses screw into the front of the lens just like filters to magnify the image. Exposure metering can still be done at full aperture without compensation.
- 2) Auto Extension Rings PK-11, PK-12, PK-13.
These fit between the lens and camera body. Used singly or in combination, exposure determination is done at full aperture with all AI-type lenses. (The PK-11 cannot be attached to the AF-Nikkor lenses.)
- 3) Bellows Focusing Attachment PB-6.
The PB-6 is also attached between the lens and camera body. Exposure is determined by the stop-down method. The beauty of this accessory is that you can change magnifications continuously by extending the bellows.
- 4) Micro-Nikkor 55mm f/2.8, 105mm f/4, and 200mm f/4 IF.
These specially designed lenses offer continuous focusing from infinity down to 1/2X lifesize. To obtain 1/2X to 1X magnification with an AI Micro-Nikkor lens, the use of an auto extension ring is required: the PK-13 for the 55mm f/2.8, and the PN-11 for the 105mm f/4; to obtain magnifications from infinity up to 1X with the 200mm f/4 IF, use the Nikon Teleconverter TC-300. Even with these accessories, exposure is determined at full aperture. Note that in close-up photography, depth of field is generally shallow. Thus, you should stop down as much as possible when photographing a subject with great depth. Since Micro-Nikkor lenses are not compatible with the F3AF's autofocus and focus-aid functions, focusing must be done by manually rotating the focusing ring  while using the matte portion of the DX-1's focusing screen. For critical

focusing in close-up photography, the use of a suitable interchangeable focusing screen and accessory viewfinder is recommended.

When using close-up equipment such as a bellows unit or extension ring(s) attached between the F3AF camera body and lens, focus-aid operation depends on lens extension from the camera's mounting flange, as shown in the following table.

	Lens maximum aperture	Maximum permissible extension of lens for focus-aid operation
Lenses from 24mm to 50mm	f/1.2, f/1.4	Twice the lens focal length
	f/1.8, f/2	Four-fifth of the lens focal length
	f/2.5, f/2.8	One-half the lens focal length
Lenses from 58mm to 85mm	f/1.2	Twice the lens focal length
	f/1.4	Four-fifth of the lens focal length
	f/2	One-half the lens focal length
	f/2.8	One-fifth of the lens focal length

For lenses not appearing in this list, focus-aid operation is impossible with any close-up equipment attached. In addition, focus-aid operation cannot be performed when a lens is mounted in the reverse position.

Notes:

- 1) The F3AF's meter coupling lever  should be pushed up before attaching a bellows unit or non-AI extension rings, such as the PK-1, 2, 3, PN-1, etc.
- 2) Before attaching the PB-6 to the F3AF, the DX-1 Finder should be first removed from the camera body.
- 3) Auto Extension Rings PK-1 and PK-11, Extension Ring K1 and Auto Adapter Ring BR-4 cannot be attached to AF-Nikkor lenses.

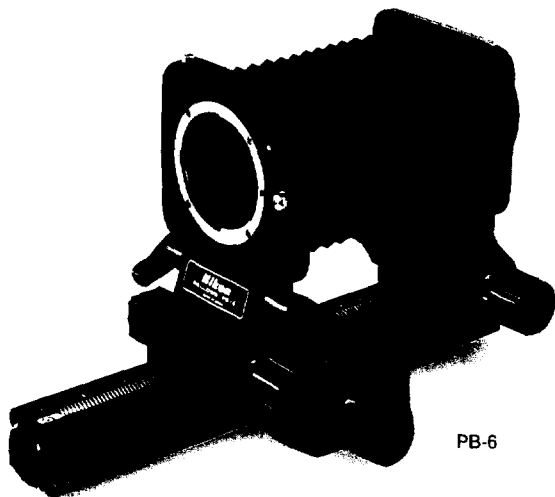

PB-6

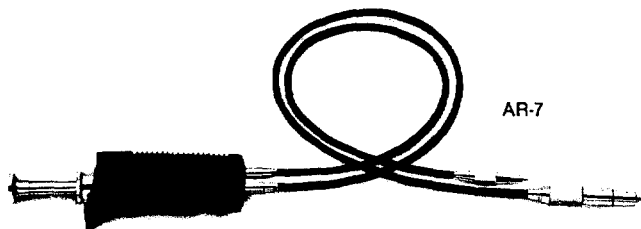

AR-7



Micro-Nikkor
Lenses



Auto Extension
Rings



Close-Up
Attachment
Lenses

ACCESSORIES—continued

Duplication work and photomicrography

The F3AF combined with the proper accessory enables you to perform duplication work or photomicrography. In these specialized areas of photography, however, focusing should be performed manually using the matte portion of the focusing screen as autofocus/focus-aid operation is, in most cases, impossible. In addition, exposure compensation is required because these areas of photography represent unusual contrast situations. Shown in the table is the relationship between specific photo types and proper exposure. Since this is meant to be a guide, in practice, you should make further compensation by experimentation until you achieve the proper results.

- 1) The exposure compensation values listed below are reference data obtained when general-purpose film was used. With color reversal film or microfilm for duplication work, it is advisable to take additional shots with \pm one-stop exposure compensation as these films have very small exposure latitude.
- 2) To avoid vibration, you can make the exposure by turning the illumination on and off.
- 3) It is advisable to use a cable release to eliminate camera vibration.

	Subject	Method of exposure measurement	Exposure compensation	Required accessories	Remarks
Copy work	Photographs and pictures with continuous gradation	Full-aperture or stop-down.	Compensation not necessary	Micro-Nikkor 55mm 1/2.8; Cable release	For high-contrast subjects, use of an 18% reflectance gray card in determining exposure is recommended. With the card, no exposure compensation is required regardless of whether the background is black or white.
	Documents and drawings of high contrast		Approx. +1 to +2 stops for black letters on white background; approx. -1/2 to -1 stop for white letters on black background.		
Slide duplication	Slide with continuous gradation	Stop-down	Approx. +1 to +2 stops	Micro-Nikkor 55mm 1/2.8; Nikon Slide Copying Adapter PS-6; Nikon Bellows Focusing Attachment PB-6; Cable release	When using Nikon Slide Copying Adapter PS-6, set the flood lamp 30cm away from its opal plate.
	Slide of documents and drawings photographed		Approx. +1-1/2 to +2-1/2 stops for black letters on white background; 0 to approx. -1/2 stop for white letters on black background		
Photomicrography	Prepared specimen	Stop-down	Approx. +1 stop	Microflex PFX	Generally, results come out better with more exposure in photomicrography. The compensation value on the left is only a guide; determine the compensation value by test shooting.

+ : more exposure - : less exposure

Anti-Cold Battery Pack DB-2

In cold weather, use the Anti-Cold Battery Pack DB-2, which accepts two AA-type batteries, as an alternative power supply to the batteries inside the camera body. Simply connect the DB-2 to the camera body, then slip the assembly inside your pocket or coat to keep it warm. This assures that the camera's metering system will function even in very cold temperatures.

Cable Release AR-3

The screw-type AR-3 makes for vibration-free shutter release.

Rubber Eyecup

Attached to the finder eyepiece $\frac{3}{8}$ ", this eyecup excludes strong light and helps prevent eye fatigue.

Eyepiece Correction Lenses

These are accessory lenses that screw into the viewfinder eyepiece to enable near- and farsighted photographers to take pictures without having to wear eyeglasses. Nine models are available, offering a choice of the following diopters: -5, -4, -3, -2, 0, +0.5, +1, +2 and +3; the diopters represent the combined dioptry of the viewfinder and lens, and not the dioptry of the eyepiece correction lens only.

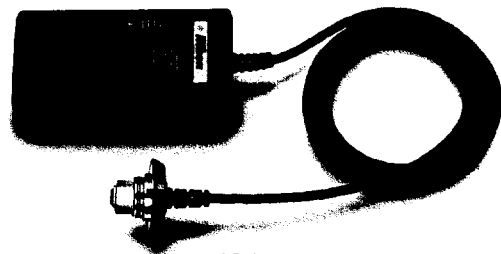

DB-2



AR-3



Rubber Eyecup



Eyepiece Correction Lenses

ACCESSORIES—continued

Filters

Constructed of Nikon's own optical glass, Nikon filters not only protect the front of the lens, but provide color correction or allow you to create special effects. As shown in the table, Nikon filters are broadly divided into the screw-in type and the drop-in type.

Notes:

- 1) For lens protection, the L39 and L37C are recommended.
- 2) When shooting a backlit subject or if there's a bright source in the frame, a ghost image is likely to result when using a filter. In this case, you should take the picture without a filter.
- 3) The F3AF's autofocus/focus-aid function cannot be used with the R60.
- 4) In low-light situations, the use of an ND filter may cause the focus-impossible warning to blink.



Lens Hoods

Recommended to prevent extraneous light from striking the lens, Nikon's lens hoods come in four styles: screw-in, slip-on, snap-on, and collapsible rubber. Every lens should be fitted with the lens hood specially designed for it. Note, however, that some lens hoods can be used in common by several lenses.



Type	Filter designation	Filter factor		Screw-in type (mm)						Drop-in type (Series 52)	Bayonet-mount type			
		Daylight	Fungus light	28	32	37	42	47	52					
For Both Color and Black-and-White Film	Skylight	L18C	1	●	●	●						●		
	Ultraviolet	L37C	1	●	●	●	●	●	●					
For Black-and-White Film	Ultraviolet	L39	1	●								●		
	Light	Y44	1.5 (1/2)	1	●							●		
		Medium	Y48	1.7 (2/3)	1.2 (1/2)	●	●	●	●	●			●	
	Yellow	Deep	Y52	2 (1)	1.4 (1/2)	●	●	●	●	●			●	
		Orange	O56	3.5 (1 1/2)	2 (1)	●	●	●	●	●			●	
	Red	Deep	R60	8 (3)	5 (2 1/2)	●	●	●	●	●			●	
		Light	X0	2 (1)	1.7 (1/2)	●								
	Green	Deep	X1	5 (2 1/2)	3.5 (1 1/2)	●								
		Soft filters	No. 1	1	●	●	●							
	For Both Color and Black-and-White Film	Soft filters	No. 2	1	●	●	●							
Polarizing		Polar	2-4 (1-2)		●	●	●							
		ND2X	2 (1)		●									
Neutral Density		ND4X	4 (2)		●	●	●							
		ND8X	8 (3)		●									
		ND16X	16 (4)		●									
		ND32X	32 (5)		●									
For Color Film		Amber	Light	A2	1.2 (1/2)	●	●	●	●					●
			Deep	A12	2 (1)	●	●	●	●					
		Blue	Light	B2	1.2 (1/2)	●	●	●	●					●
	Deep		B12	2 (1)	●	●	●	●						

() indicates increase in f/stop

Camera Cases

Two camera cases are available for the Nikon F3AF: The CF-24 Semi-Soft Leather Camera Case houses the camera body with AF-Nikkor 80mm f/2.8 attached; the CF-6 Leatherette Speed Camera Case accepts the camera, plus AF-Nikkor 200mm f/3.5 IF-ED.

Neckstraps

Available are the leather neckstrap AN-1 (black), webbed nylon neckstraps AN-4Y (yellow) and AN-4B (black), and wider webbed nylon neckstraps AN-6Y (yellow) and AN-6W (brown).

Compartment Cases

A wide selection of six types to choose from, ranging from a compact model to a large type which can accommodate large or bulky camera equipment: FB-8, FB-11A, FB-14, FB-15, FB-16 and FB-17.

CF-24



CF-6



AN-6Y



AN-4Y



FB-11A

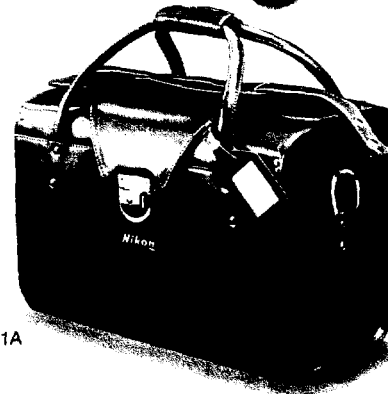

EV RANGE OF CAMERA

The camera's meter may be used only within the shutter speed range covered by the exposure value (EV) range of the meter, which varies with the aperture and ASA/ISO setting.

The charts on pages 68 and 69 show the relationships between the f/stop, shutter speed and film speed, indicating the usable functioning shutter speed (for metering purposes) with any film speed/aperture combination.

Careful attention to the following instructions will assure precise exposure, automatically, over the complete exposure control and meter range capabilities of your Nikon F3AF.

What Is EV?

Exposure value (EV) is a number representing the available combinations of shutter speed and aperture that give the same exposure effect when the scene brightness and ASA/ISO remain the same.

At ASA/ISO 100, the combination of a one-second shutter speed and an aperture of f/1.4 is defined as EV 1. If the aperture is stopped down by one full f/stop or the shutter speed is one step faster, the EV increases by one; if the aperture is opened up by one full f/stop or the shutter speed is one step slower, EV decreases by one. Using ASA/ISO 100 as an example, 1 sec. at f/2 represents EV 2, 1 sec. at f/5.6 represents EV 5, while 1/125 sec. at f/5.6 represents EV 12. Because the exposure is the same, 1/30 sec. at f/11 and 1/1000 sec. at f/2 both represent EV 12.

How to Read the EV Chart

Section A of the chart shows the usable EV range depending on the lens' maximum aperture in full-aperture metering, while it also indicates the usable EV range for aperture settings in stop-down metering. Section D shows the value for the ASA/ISO film speed, Section B the aperture settings for various film speeds, and Section C the shutter speeds to match any film speed/aperture combination.

In practice, you will find that it is generally the high end and the low end of the metering range which require a careful check. The EV range of the Nikon F3AF encompasses most lighting situations, and it is only under very dim or very bright picture-taking situations that you need pay any special attention.

Full-aperture metering

Use the Nikkor 50mm f/1.4 lens and a film speed of ASA/ISO 100 as an example. By referring to the f/1.4 column in Section A and the EV value indicated for ASA/ISO 100 in Section D, you will find that the F3AF's EV range in this case is 1 to 18.

If the lens is set at f/5.6, refer to Section B and single out the f/5.6 indication for ASA/ISO 100. Go diagonally down until the protruding line intersects with Section C's vertical line for a shutter speed of 8 sec. (the F3AF's slowest shutter speed). From this point of intersection, follow the horizontal line that leads to the Section D's EV value for ASA/ISO 100, and you will obtain an EV range of 2. Start again from the f/5.6 indication

for ASA/ISO 100 in Section B, and go down diagonally until the protruding line intersects with Section C's vertical line for a shutter speed of 1/2000 sec. (the F3AF's fastest shutter speed) this time. Then follow the horizontal line that leads to Section D's EV value for ASA/ISO 100, and you will get a reading of EV 16. This means that at an *f*/stop of *f*/5.6 at ASA/ISO 100 and at shutter speeds from 8 to 1/2000 sec., the effective metering range is EV 2 to 16, which is well within the F3AF's metering range of EV 1 to EV 18.

The green area in Chart 1 encompassed by the heavy lines in Section C demonstrates the usable shutter speed range to match any film speed/aperture combination at ASA/ISO 100. (The minimum aperture of the lens is *f*/16.)

Similarly in Chart 2, the usable range (at ASA/ISO 100) for the AF-Nikkor 80mm *f*/2.8 lens is shown in green.

Two red lines in Section C of both charts indicate the EV value ranges of the scene brightness usable with autofocus or focus-aid operation. Therefore, the combinations of shutter speeds and apertures indicated in the areas outside the lines are not usable.

Stop-down metering

For stop-down metering, Section A indicates the usable EV range for various aperture settings. For example, if the lens is stopped down to *f*/8 at ASA/ISO 100, refer to the *f*/8 column in Section A and the EV values indicated for ASA/ISO 100 in section D, and you will find that the EV range for *f*/8 is EV 6 to 23. Now single out *f*/8 at ASA/ISO 100 in Section B. Go diagonally down until the protruding line intersects with Section C's vertical line for the shutter speed of 8 sec. From this point of intersection, follow the horizontal line that leads to Section D's EV value for ASA/ISO 100, and you will obtain an EV reading of 3. This means that an *f*/stop of *f*/8 at ASA/ISO 100 and a shutter speed of 8 sec. give an EV value outside the metering range. To find out the slowest shutter speed usable, follow the *f*/8 indication for ASA/ISO 100 in Section B diagonally down until it intersects the horizontal line in Section C that leads to Section D's EV value of 6 for ASA/ISO 100, and you will find that the slowest shutter speed usable is 1 sec. In other words, at *f*/8 at ASA/ISO 100, the available shutter speed range from 1 to 1/2000 sec. has an effective EV range from EV 6 to 17 (indicated by the broken line in Section C)—well within the metering range.

EV RANGE OF CAMERA—continued

Chart 1

(for the Nikkor 50mm f/1.4)

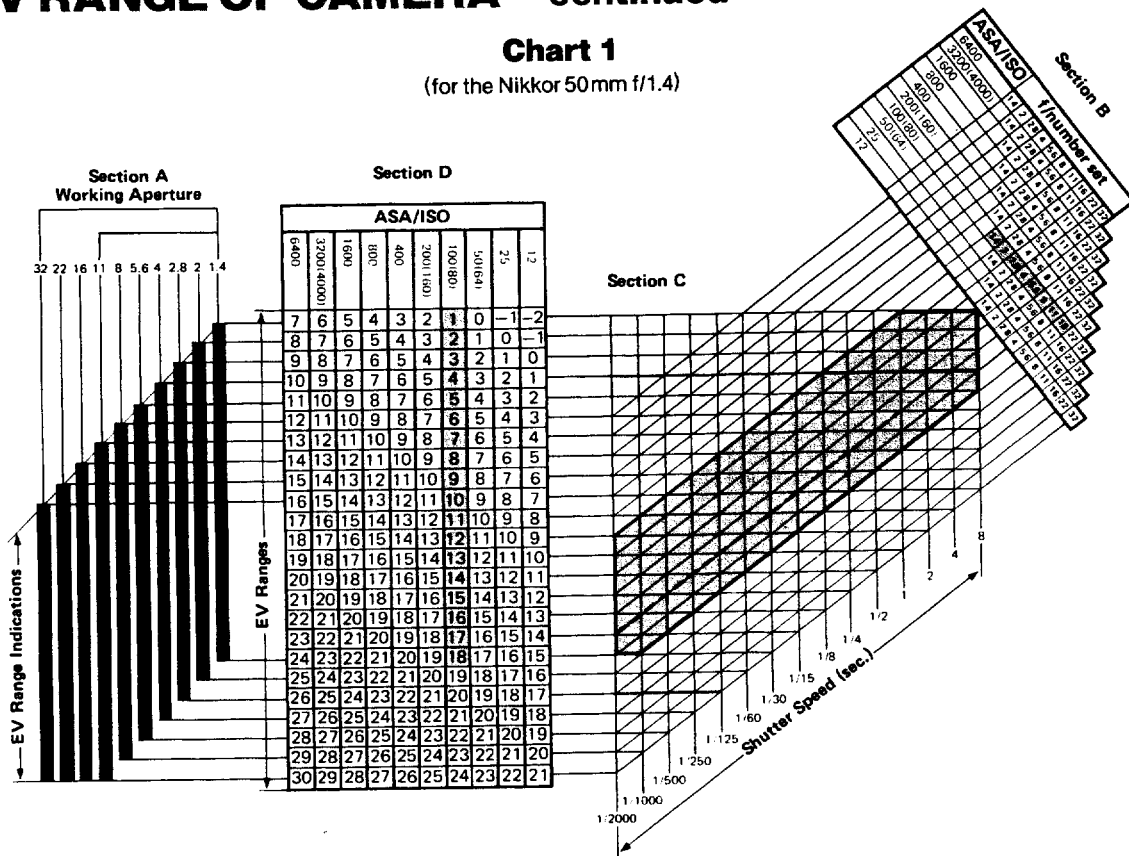
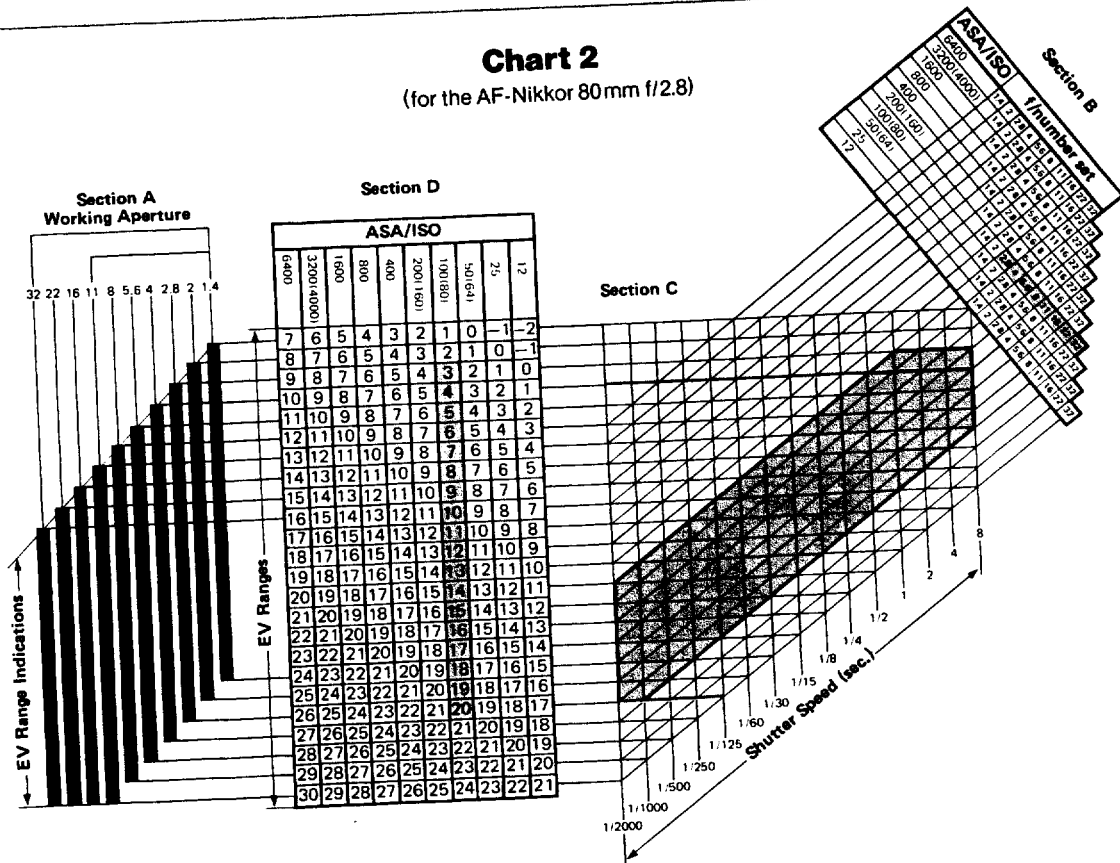
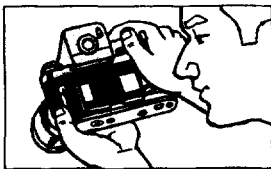

Chart 2
(for the AF-Nikkor 80mm f/2.8)



TIPS ON CAMERA CARE

Although the F3AF is a tough and durable camera, bear in mind that it is a precision optical instrument and that careless or rough handling may damage it. Observe the following tips, and the F3AF will always work as perfectly as the day you bought it.



- Before using the camera, it is a good practice to check it thoroughly first.

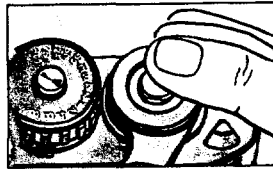

- Do not force your camera's controls—they are designed to work with a minimum of pressure.

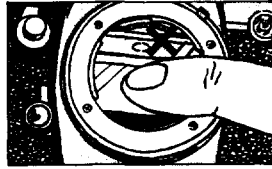

- Do not touch the AF contacts ②, reflex mirror ③ or the focusing screen to prevent them from getting dirty or scratched. Remove dust with a blower brush.

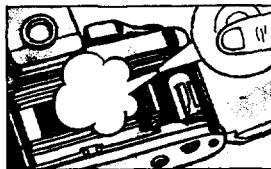

- Clean metallic parts with a blower brush or with a dry, soft cloth.

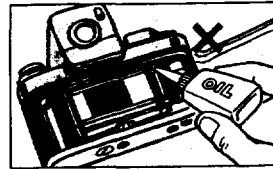

- Generally, the camera does not need lubrication. To keep your F3AF in top working order, it is recommended that you trip the shutter and operate the film advance lever a few times each month with or without film loaded in the camera.

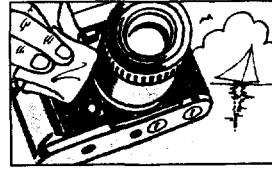

- If the camera body is exposed to rain or mist, wipe moisture gently with a soft cloth and dry the camera. After using the camera near salt water, take care that you wipe it with a cloth moistened with pure water to remove possible traces of salt.

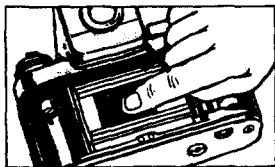

- Avoid touching the camera's interior surfaces, especially the shutter curtains ① and film pressure plate ④.

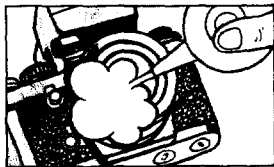

- Clean glass surfaces such as the lens or the finder eyepiece ② with a blower brush; avoid using lens tissue as much as possible. Gently wipe dirt, smudges or fingerprints with soft cotton moistened with a small amount of absolute alcohol, using a spiral motion from center to periphery. Make sure you leave no wiping traces.

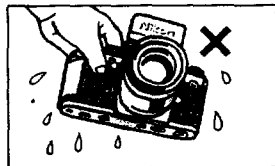

- If the inside of the camera body accidentally gets wet, its internal precision parts may get rusty. Take the camera right away to the nearest authorized Nikon dealer for a checkup. Work of this sort may require repair payment.

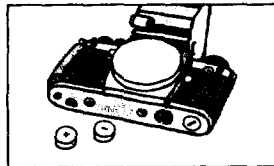

- When not using the camera for a long time, take out the batteries. Without lens, always keep the body cap on. Store the camera away from high temperature, high humidity, naphthalene, or camphor.

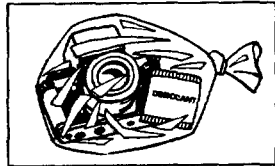

- In a humid environment, it is best to store the camera in a vinyl bag with a desiccant to keep away dust, moisture and salt.

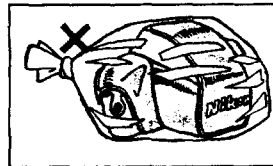

- Storing leather cases enclosed in a vinyl bag may cause the leather to deteriorate, so exercise due care.

Caution: Use of a spray-gun type blower to clean the lens may cause possible damage to the glass (especially when ED glass is used for the front lens element), by suddenly lowering the temperature on the lens surface. To avoid damage, hold the blower upright, keep its nozzle more than 30cm away from the lens surface and move the nozzle around so

that the stream of air is not concentrated in one spot.

TIPS ON BATTERY USE

- 1) Battery power falls off in extremely cold temperatures and this may cause the camera's photometric circuit to cease to operate. In this situation, use new batteries and protect the camera body from the cold. Note that battery power will be recovered as soon as the temperature becomes normal.
- 2) When not using the camera for a long period of time, take batteries out and store them in a cool (below 25°C), dry place. Should the batteries be left in the battery chamber for a long period of time, insufficient contact may occur due to battery contamination. Thus, it is good practice to periodically clean the batteries and the contact section in the battery chamber with a soft cloth. If the battery chamber is stained by a leaking battery, remove the batteries at once and clean the chamber.
- 3) Never mix new and old batteries or batteries of different makes.
- 4) Always check battery power before every shooting session. It is a good idea to have spare batteries on hand during a lengthy shooting assignment.
- 5) Keep batteries away from infants and small children. In case a battery is accidentally swallowed, call a doctor immediately as the material inside the batteries can cause serious problems.
- 6) Never disassemble batteries or dispose of them by burning.

ABOUT THE LIQUID CRYSTAL DISPLAY (LCD) _____

- 1) At high temperatures (over approx. 60°C), the whole surface turns black so that the exposure information cannot be read. However, this situation will return to normal when the temperature drops.
- 2) Avoid storing the camera in excessively hot places, such as in a car parked in direct sunlight or inside the trunk. You may shorten the LCD's life by doing so.
- 3) When the temperature goes below freezing, the response time decreases as the liquid crystal becomes more viscose.
- 4) Although the Nikon F3AF employs the highest quality LCD, it deteriorates in contrast and becomes difficult to see after six or seven years. When this happens, please contact your dealer or the Nikon service facility nearest you for replacement of this element at a small charge.

SPECIFICATIONS



Type of camera	35 mm single-lens reflex	backup mechanical control;
Picture format	24 mm×36 mm (standard 35 mm film format)	through-the-lens, full aperture
Lens mount	Nikon bayonet mount	metering via silicon photodiode
Lenses	Autofocus operation: AF-Nikkor 80 mm f/2.8 and 200 mm f/3.5 IF-ED; focus-aid operation: more than 30 Nikkor and Nikon Series E lenses with maximum aperture of f/3.5 or faster; manual operation: more than 60 Nikkor and Nikon Series E lenses available	(SPD) with centerweighted metering pattern and metering circuits incorporated into camera body; meter works with all viewfinders EV 1 to EV 18 at ASA/ISO 100 with f/1.4 lens or EV 3 to EV 20 at ASA/ISO 100 with f/2.8 lens
Focus detecting system	TTL image displacement detecting system by SPDs built into AF Finder DX-1	Horizontal-travel, titanium focal- plane shutter
Brightness range for autofocus/ focus-aid operation	Approx. EV 4~EV 20 (at ASA/ISO 100)	Metering range
Focus information display	Visible in the viewfinder via red LEDs; two red arrows light up to indicate correct focus in autofocus/ focus-aid operation, right- or left- hand arrow indicates out-of-focus image (too near or too far), red X glows when autofocus/focus aid is impossible or subject is out of focus to great extent	Shutter
Focus lock buttons	Two buttons provided on AF-Nikkor lens barrel; either locks lens distance setting during autofocus operation	Shutter speeds
Exposure control system	Aperture-priority automatic exposure with manual override and	Auto: electromagnetically controlled stepless speeds from 8 to 1/2000 sec.; manual: quartz/electro- magnetically controlled discrete speeds from 8 to 1/2000 sec., plus B and X (1/80 sec.); mechanical: T setting on shutter speed dial and 1/60 sec. when using backup mechanical release lever
		Exposure information display
		Visible in the viewfinder via LCD; on auto, discrete shutter speed closest to automatically selected speed is displayed, overexposure indicated by + 2000 and -8- indicates underexposure; on manual, M appears with + or - indicating over- or underexposure and - + correct exposure; aper- ture in use also shown through aperture-direct-readout (ADR) window

Shutter release button	Electromagnetically releases shutter; initial pressure on shutter release button switches on meter and autofocus/focus-aid function (after power switch is turned on), meter and autofocus/focus-aid function then remain on for 16 sec. after finger is taken off button	Auto flash control system	TTL direct flash control governs output of Nikon dedicated flash unit using camera's SPD sensor; effective ASA/ISO range from ASA/ISO 25 to ASA/ISO 400
Backup mechanical release lever	Trips shutter at 1/60 sec. regardless of shutter speed dial setting except at T; used when batteries are dead	Accessory shoe	Special Nikon type located at base of rewind knob; has hot-shoe contact, ready-light contact, and TTL flash output control contact; accepts Nikon SB-12, SB-16A or SB-17 shoe-mounting electronic flash unit or TTL connecting cord from SB-11 or SB-14 for TTL direct flash output control using camera's SPD metering cell
Viewfinder	Interchangeable eyelevel pentaprism type AF Finder DX-1 as standard; 0.8X magnification with 50mm lens or 1.3X with 80mm lens, both lenses set at infinity; approx. 92% frame coverage; five other types available	Sync terminal	Threaded type provided for off-camera or multiple-flash photography
Viewfinder illuminator	Illuminates both LCD and ADR f-number	Flash synchronization	Speeds of 1/80 sec. (X) or slower with electronic flash; with Nikon dedicated flash unit, flash sync is automatically set to 1/80 sec. when shutter speed dial is set at A or 1/125 sec. or above; at slower speeds, shutter fires at the speed set
Finder terminal	5-pin terminal provided for accessories	Flash ready-light	Visible in the viewfinder; LED lights up when Nikon dedicated flash unit is completely recycled or blinks to warn of insufficient light output, improper flash connection, or improper ASA/ISO setting
Focusing screen	Fixed matte type screen is built into the AF Finder DX-1; with viewfinders other than DX-1, 21 interchangeable screens are available		
Film speed range	ASA/ISO 12 to ASA/ISO 6400		
Exposure compensation dial	±2 EV compensation is possible in one-third increments		
Exposure memory lock button	Operates on auto to electronically lock in shutter speed		

SPECIFICATIONS—continued

Film advance lever	Wound in single stroke or series of strokes with 30° stand-off angle and 140° winding angle	Batteries	Two 1.5V AAA-type alkaline-manganese or zinc-carbon batteries in the AF Finder DX-1 for autofocus/focus-aid operation; two 1.55V silver-oxide cells (Eveready EPX76, D76 or equivalent), two 1.5V alkaline-manganese cells, or one 3V lithium battery for camera body
Automatic film advance	Possible with optional Motor Drive MD-4		148.5mm(W)×115.5mm(H)×90.0mm(D) with AF Finder DX-1
Frame counter	Additive type, self-resetting; for blank exposures before frame one, shutter speed automatically set to 1/80 sec. with shutter speed dial set to A or 1/125 sec. or above	Dimensions	Approx. 950g with AF Finder DX-1 (including batteries)
Film rewind	Via folding crank and rewind button in baseplate	Weight	
Self-timer	Quartz-timed 10 sec. delayed exposure; LED blinks at 2Hz for first 8 sec. then at 8Hz for last 2 sec.		
Eyepiece shutter	Prevents stray light from entering viewfinder from the rear during self-timer operation		
Depth-of-field preview button	Coaxial with mirror lockup lever		
Reflex mirror	Automatic instant-return type with lockup facility; incorporates air damper		
Multiple exposure lever	Disengages frame counter for correct count		
Camera back	Hinged interchangeable type; memo holder provided		
Power switch	Switches on when turned clockwise to uncover red dot		

IMPORTANT!

The Nikon F3AF is an AI-type (Automatic Maximum Aperture Indexing) camera which performs full-aperture metering with AI-type lenses. The aperture ring of these lenses has a meter coupling ridge  and a meter coupling shoe  containing two holes (see illustration). Almost all lenses now manufactured by Nikon are of the AI type. However, please confirm whether or not your lens is AI before using it with the F3AF. Note that the "AI" or "AI-S" mark on the cover of the instruction sheet or book provided with AI-Nikkor lenses is your assurance that the lens offers the AI feature. All Nikon Series E lenses have the AI feature but do not have a meter coupling shoe.

To attach an AI-type lens to the camera body, follow the directions provided in the BASIC OPERATION section of this instruction manual. If the lens is a non-AI type, stop-down exposure measurement is required with the camera body's meter coupling lever  locked up (refer to the page 41).

Note: The modification, at reasonable cost, of most non-AI Nikkor lenses having both an automatic diaphragm and meter coupling shoe, is available for the convenience of Nikkor lens users. For further information concerning lens modification, please contact your local authorized Nikon dealer.

