



INTRODUCTION



H6X

Medium format photography is about professionalism. Camera systems have to be professional, handling has to be professional and captures have to be professional in quality. Hasselblad knows it and delivers it; professionals know that too.

The Hasselblad H series of cameras consists of building new developments on the shoulders of the previous generations of cameras. In this way all the previous work-experience based and branch-demanding features are automatically included. So, just when you think things can't get much better, they do.

The H6X heralds a step up that is noticeably greater than before. The changes are many and 'from the ground up'. The H spirit thrives but has now matured to reinforce further its position in the rapidly changing world of digital imaging. Future proofing is key to a secure placing for working photographers. The H6X provides a reliable connection to the fleeting environment of digital imaging technology so when the wind changes direction, the H6X remains as the safeguarding companion to provide support.

True to Hasselblad philosophy, interchangeability and versatility is integral in the H6X regarding lenses and accessories with minimal restrictions. In addition, there is now the opportunity of exploiting HCD 24mm, HCD 28mm and the HCD 35-90mm lenses together with film magazines and 3rd party digital backs. Although aimed primarily at current H1, H2, H2F, H4X and H5wX users wishing to upgrade to H5 capabilities, the H6X can naturally act as a backup for H5 users too. In short, you have access to a more comprehensive world to apply medium format quality

Hasselblad's best kept secret is knowing that every link in the chain that leads to the page in the magazine has to reach a certain standard; it is that simple. That's why Hasselblad spends so much time and energy into checking those almost endless behind-the-scenes details and standards because they understand this simple concept. There is no magical formula to Hasselblad success other than an understanding of what is required to produce the best results available in the world today and an acceptance that there are no short cuts in this process. Hasselblad does its best to produce the best; there is no other way to achieve the Hasselblad star quality.

The H6X uses stainless steel and aluminium to endure the treatment handed out in professional use – and that can be pretty tough.

The sturdy but ergonomic integral grip incorporates not only the battery but the user interface too. It is here, by way of the surrounding buttons, that you enter the 'control room'. Customization is a very prominent concept that you experience in the Hasselblad world that ensures it is the photographer that controls the camera, not vice versa. Accessed through the grip alone, there are 34 separate custom options.

The H6X incorporates a list of quality enhancing features. True Focus, for example, is used by some on a daily basis while Digital Lens Correction is used by others for every single shot.

True Focus is the pet feature for many fashion photographers who work fast and by instinct. They don't have the time to double check focus for every single split second shot and neither do they have the time to get it wrong. True Focus delivers the sharpness in an intuitive manner, at speed.

Digital Lens Correction, applied in Phocus at the file editing stage, takes a discerning look at any colour aberration, distortion and light fall off however minor (which is inherent in any lens, anywhere) and resolves the situation automatically.

We hope you will enjoy taking advantage of all the new photographic opportunities that your new H6X camera offers you.

CONTENTS

Introduction	3				
System requirements	5				
Warnings & restrictions	5				
■ General overview – controls and displays	6				
Parts, components, buttons	6				
Grip buttons & controls	7				
Camera body buttons & controls	8				
Viewfinder	9				
Display overview	9				
Grip display	10				
Viewfinder display	11				
Reassignable grip buttons	12				
Shortcuts	13				
■ General	15				
Carrying strap	15				
Rechargeable battery grip	15				
Battery charger	15				
Charging the battery	16				
Battery grip – precautions	16				
Battery life	17				
Battery warning	17				
Battery status	17				
Power modes	17				
Viewfinder screen	18				
Attaching /removing sensor unit	18				
Protective baseplate	18				
Attaching /removing the viewfinder	19				
Eyepiece adjustment	19				
Rubber eyecup	19				
Accessory connection	19				
PC-connector	19				
■ HM 16-32 Film Magazine	20				
Parts & Components	21				
LCD panel	21				
LCD Illumination button	21				
Change up / down button	22				
Function selector	22				
Film plane index	22				
Darkslide key	22				
Darkslide indicator	22				
Film tab holder	23				
Magazine settings lock	23				
Databus interface	23				
Battery	23				
Battery replacement	23				
Attaching / removing the magazine	23				
Settings	23				
Film speed setting/barcode	25				
Film length/number of frames	25				
Data imprint setting	26				
Frame counter setting	26				
Low-battery symbol	26				
Film loading	27				
Film wind on and off	27				
Unloading a film	27				
■ Digital	28				
Formatting CF cards	29				
Hasselblad workflow	29				
Phocus	30				
■ Lenses & focus modes	31				
Attaching/removing a lens	32				
Lens cap	32				
Lens shades	32				
Shutter and aperture control	32				
Filters	32				
Focusing distance calculation	32				
Depth-of-field preview	33				
Infrared focus settings	33				
Focus assist	33				
Manual focus	35				
Autofocus	35				
Single shot	36				
Continuous	36				
True Focus	36				
True Focus, Absolute position lock	37				
True Focus and camera handling	38				
Focus checking	38				
True Focus, four methods	39				
■ Exposure Control	41				
ISO & white balance	42				
Light metering modes	42				
Exposure setting modes	43				
Manual exposure mode	43				
Automatic exposure mode	44				
Mark overexposure	44				
AE-L button	45				
Exp compensation/Quick Adjust	46				
Fixed Exposure compensation	46				
■ Menu	47				
Navigating menu and settings	48				
Overview of menu	49				
Self Timer	50				
Bracketing	52				
Interval	54				
Settings	55				
Custom Options	55				
Image Info	60				
Image info text setting	61				
Date & Time	61				
System status	62				
Drive	63				
■ Profiles	64				
Making a profile	65				
Using profiles	66				
Changing a profile name	66				
■ Flash /strobe	67				
General	68				
Integral flash	69				
Flash measure	70				
■ Accessories	71				
■ Appendix	76				
Technical Specifications	77				
Default settings	78				
Light metering sensitivity	78				
True Exposure	79				
P & Pv modes	79				
Problems, Equipment care and service	80				
Index	81				

WARNINGS, RESTRICTIONS AND RECOMMENDATIONS

- Keep the H6X and computer equipment away from moisture wherever possible. If your camera becomes wet, disconnect from power and allow it to dry before attempting to operate again.
- Always take great care when you remove the sensor unit for cleaning as the exposed CCD sensor protective filter is vulnerable to damage.
- Keep all cables connected to or from your camera and computer out of the way where they will not be tripped over.
- Your new Hasselblad camera may have been supplied in kit form or as separate items. There are a number of possible combinations depending on factors such as offers, bundles etc. Please ensure that all the items noted on the accompanying packing information have been supplied and are correct.
- Contact your Hasselblad dealer or distributor immediately if anything is missing or seems faulty in any way, quoting the serial numbers and purchase details where appropriate.
- Please keep purchase details and the warranty in a safe place.
- Become familiar with the various parts and components. Leave protective covers on as much as possible and avoid touching glass surfaces and inserting fingers into the camera body. Hasselblad cameras have a robust construction and are capable of withstanding fairly rough treatment but nevertheless are precision instruments and will serve you longer if treated with respect from the beginning.

FIRMWARE UPDATES

If you have registered your camera you should automatically receive e-mail informing you of the latest developments. Otherwise you are advised to make regular checks regarding firmware updates to the camera body, the lens and the viewfinder. Firmware updates to the camera body, lens and viewfinder can be done by using a H5D or H6D sensor unit or by contacting your local dealer.

The aim is to ensure you have the latest firmware updates for camera body, sensor unit and viewfinder, which naturally ensures the optimum in performance. When updating you should also study the accompanying 'Release Notes' or 'Read Me' files where you will find details about improvements, developments and changes.

USER MANUAL

This user manual is primarily designed for on-screen PDF reading to exploit search tools etc. However, there is a sufficiently wide left margin to allow one-sided print outs to fit an ISO standard ring binder if required.

Please note that the format is A4 to conform with the most common standard. Therefore if printing out to US Letter format or similar please ensure you select "Fit to Printable Area" in the page scaling dialogue.

Register your camera for regular news about the latest developments, updates, news, tips, and much else!

– www.hasselblad.com –

PARTS, COMPONENTS, BUTTONS AND CONTROLS – OVERVIEW

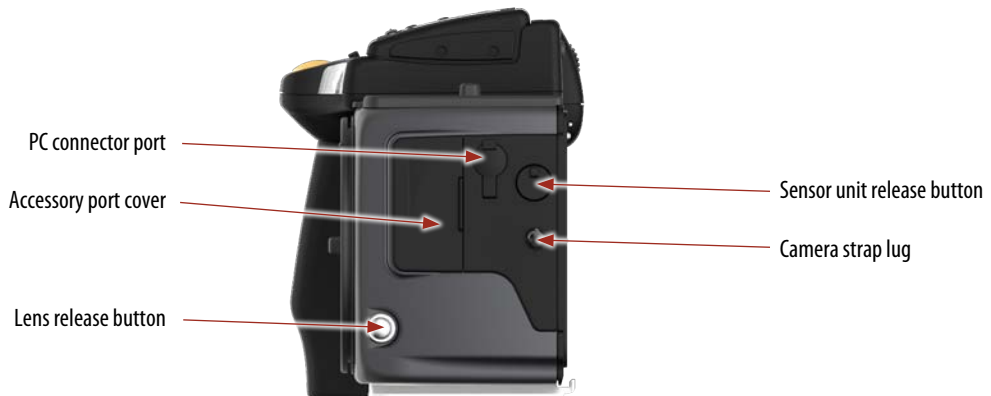
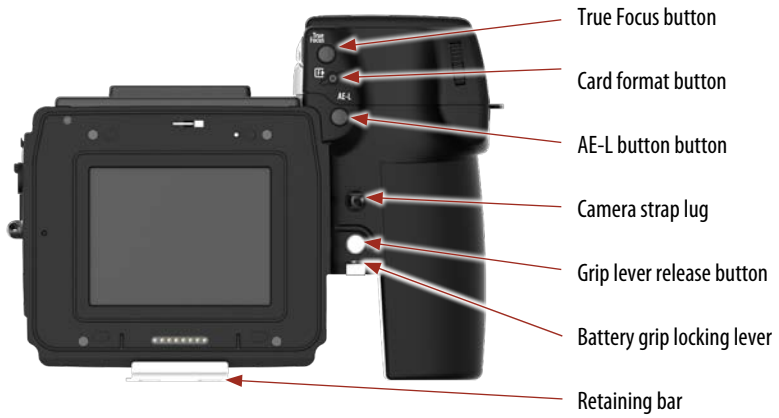
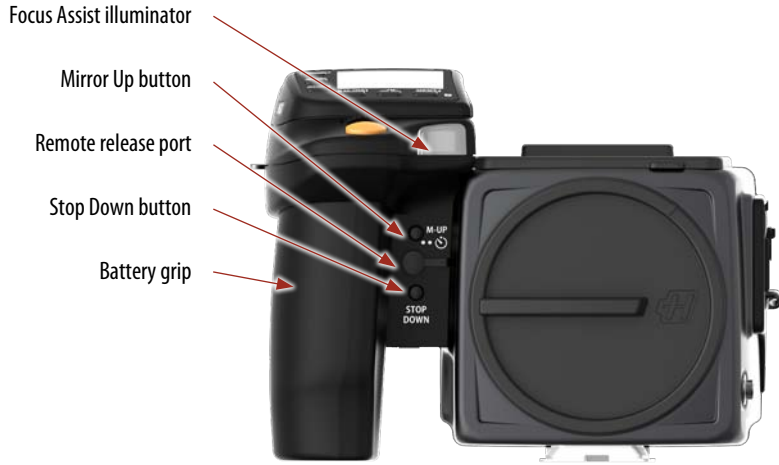

GRIP BUTTONS AND CONTROLS - DESCRIPTION

Note that some of the buttons are modal and so have multiple functions according to the setting being made.

1 Shutter release button

This button has **half-press** and **full-press** positions. By pressing half-way (or softly) the camera, auto focus function and exposure meter can be activated. By pressing all the way down (or more firmly) the shutter will be released (or the chosen exposure procedure for example, the self timer is activated with this button).

2 Front scroll wheel

The front and rear scroll wheels are used to make changes in exposure settings and provide access to the grip menu for settings. The effect of the wheels' direction is customizable.

3 FLASH / (Control Lock) button) / (EXIT)

This is a triple function button. If you press the button for one second, the beeper will sound (if set) and a key symbol will appear on the grip display signifying that the controls (except the shutter release) have been locked and therefore cannot be altered unintentionally in use. Press the button for one second again to unlock (this function can be altered to lock all controls or scroll wheels only in **Custom Options #18** on grip). Quickly clicking the button will access the flash settings information on the display from the main screen. See under *Flash /Strobe - controls and displays* for full details.

This button also acts as the **EXIT** button for many settings.

4 AF button / (ON) / (SEL.)

This is a triple function button. Press this button to directly access the autofocus/manual focus choice screen from the main screen. See under *Lenses* for full details. It also acts as the **ON** and **SEL.** (= select) buttons for many other settings.

5 ISO/WB button / (SAVE) / (ENTER)

This is a triple function button. It provides direct access to the ISO and White Balance settings – with *HSD sensor units only*. See under *Light Metering & Exposure Control* for full details.

It also acts as the **SAVE** and **ENTER** buttons for many other settings.

6 MENU button

Accesses the first level of the menu for settings changes.

7 Illumination/Battery status button

Press to illuminate the display. Remains active until camera enters Display Off mode. Hold down to access battery status/general information screen.



8 ON / OFF (Profiles) button

Press the button for 1 second to activate the camera. The H6X start-up logo will appear and then the main screen. After a few seconds (customizable) the camera will enter Display Off mode.

A long press of the button will turn the camera off completely (even from Display Off mode) signified by an audible signal (if set).

A quick 'click' on the button will access the Profiles feature (see later section for details).

Note the difference in results between a long press and a quick click of this button.

9 Rear scroll wheel

The front and rear scroll wheels are used to make changes in exposure settings and provide access to the grip menu for settings. The effect of the wheels' direction is customizable.

EXAMPLE

In this example of making a Bracketing setting, the top three buttons – Flash, AF and ISO/WB – will temporarily function according to the description on the screen – Exit, On and Save.

The buttons return to the standard function when you exit from the setting.



CAMERA BODY BUTTONS AND CONTROLS - DESCRIPTION

Note that some of the buttons can be re-assigned to another function.

There are three control buttons on the rear of the grip.

1 True Focus button

At default setting, activates **True Focus** (see separate section for description) but also acts as a **Zoom-in** button when browsing or **Selector** button when making a setting change on the sensor unit, according to mode.

Can be reassigned in Custom Options to another function.

2 CF Card format button

Re-formats a CF card. Purposefully recessed to prevent unintentional use. Dialogue appears for confirmation – *for use with HSD sensor units only.*

3 AE-L button

At default setting, activates **AE-L** that can lock a light reading made in both automatic and manual exposure modes. Also acts as a **Zoom-out** button when browsing or **Selector** button when making a setting change on the sensor unit, according to mode.

Can be reassigned in Custom Options to another function.

See under **Light Metering & Exposure Control / AE-L button** for full details.

There are three control buttons on the front of the grip.

4 M.UP button

Press to raise the mirror and press again to lower it (toggle function). A quick double press of the button (two within a half second) will immediately access the **Self timer** function.

Can be reassigned in Custom Options to another function.

5 Remote release cord port

For attaching a remote release cord (electrical). The jack plug socket is protected by a captive rubber plug.

6 STOP DOWN button

Press to make a visual check of the depth-of-field on the viewfinder screen at the chosen aperture. The aperture will close according to the setting and remain closed as long as the pressure is maintained. You can alter the aperture at the same time to see the changes taking place.

Can be reassigned in Custom Options to another function.



Note

Customizable buttons are particularly useful and can save you a great deal of time and effort. You are advised to investigate their potential fully!

See separate section for full details.

VIEWFINDER – (NOT INCLUDED)



1 Hot shoe

Connection for automatic flash unit (with SCA 3902 adapter) or for wireless flash connection.

2 Rubber eye cup

Can be exchanged for another model.

3 Eyesight adjustment wheel

The personal eyesight adjustment facility has a diopter range of -5 to +3.5, to suit most users.

4 Exposure compensation button

Press this button to access the EV compensation screen. Settings are made with either the front or rear scroll wheels. An EV correction symbol appears on the grip and viewfinder display as confirmation.

5 Exposure mode / metering mode button

The EXP (Exposure) button accesses the exposure and metering mode options screen. Settings are made with the front and rear scroll wheels and the appropriate symbols appear on the grip and viewfinder displays accordingly.

6 Integral flash unit

Guide number 12.

7 Integral flash unit release button

Slide the button towards the rear of the camera to raise the flash. Activation is automatic.

8 Viewfinder release button

DISPLAY INFORMATION – OVERVIEW

Viewfinder information	GRIP LCD INFORMATION
<ul style="list-style-type: none"> • Metering method • Aperture setting • Shutter speed • Exposure method • Capture counter • Exposure compensation • Focus assist • Warning triangle • Flash warning • Spirit Level ¹⁾ 	<ul style="list-style-type: none"> • Metering method • Aperture setting • Shutter speed • Exposure method • Capture counter • ISO • White Balance • Flash indication • Focus • Drive • EV • Battery status • Histogram ¹⁾

¹⁾ for use with H5D/H6D sensor units only

¹⁾ for use with H5D/H6D sensor units only

PHOCUS / PHOCUS MOBILE INFORMATION

for use with H5D/H6D sensor units only

- | | |
|--|---|
| <ul style="list-style-type: none"> • Metering method • Aperture setting • Shutter speed • Exposure method • ISO | <ul style="list-style-type: none"> • Focus method • EV • Histogram • Exposure adjustment • Capture preview |
|--|---|



TYPICAL GRIP DISPLAY

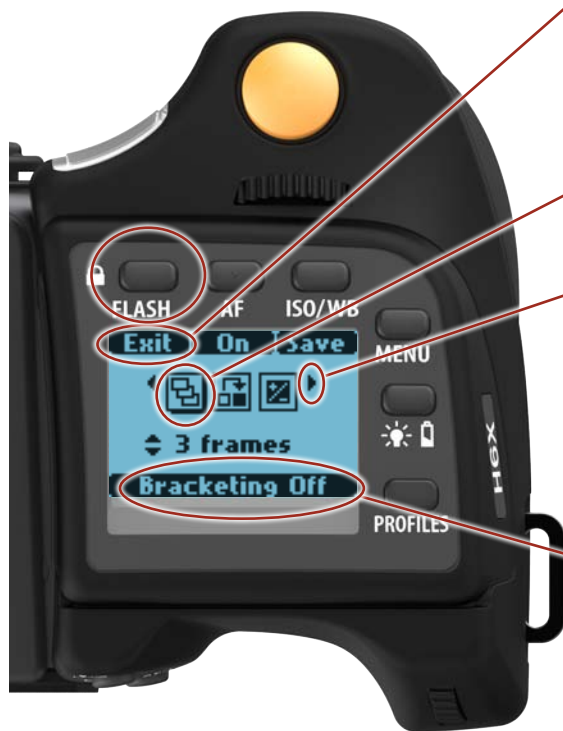
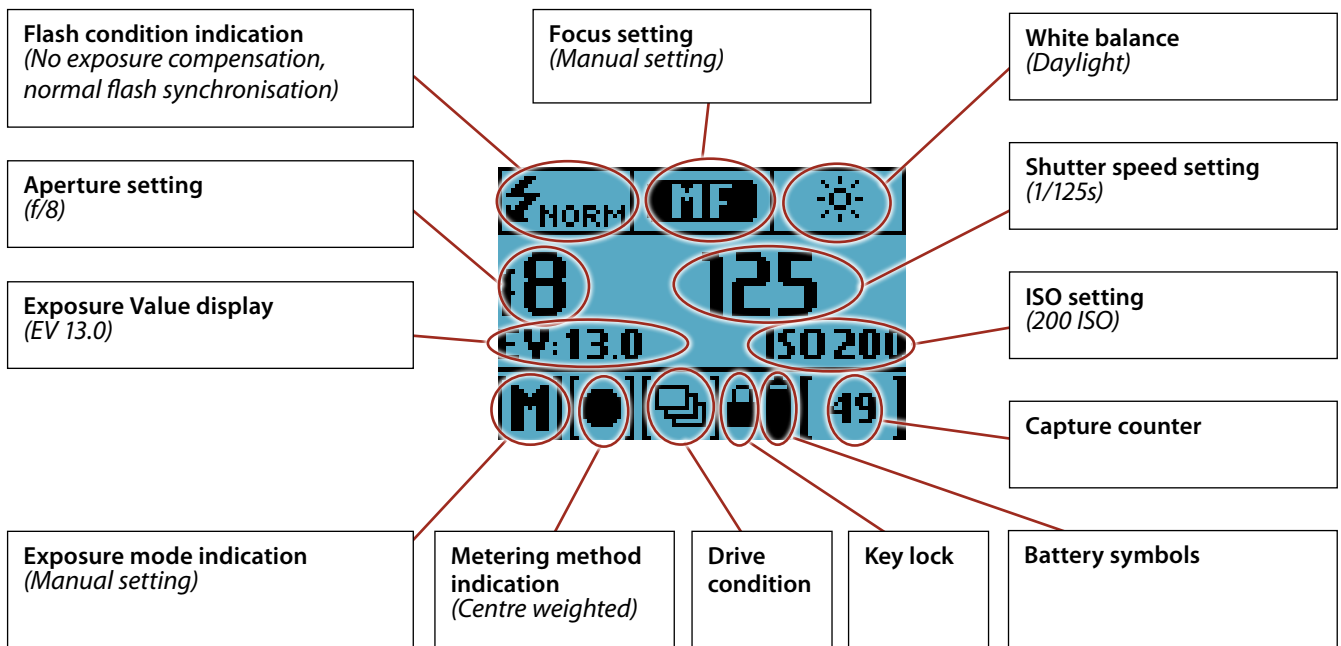

Typical camera grip display when changing settings.

Command indication

The upper row on the screens describes commands (that change according to the setting). The button immediately above each command effects the change. So in this case, for example, you would press the FLASH button to Exit from the screen. See note below.

Settings symbols

Symbolize the options available when settings are changed. The active symbol is depicted by a drop shadow.

Scroll wheel description and direction

Arrowheads symbolize which scroll wheel should be used to change the setting they are beside. In this case, the Bracketing option is chosen by the front scroll wheel and the number of captures in that option is chosen by the rear scroll wheel.

- ◀...▶ = front scroll wheel
- ◆ = rear scroll wheel

Setting information

The lower row on the screen displays information about the current state of the setting. In other words, the upper row displays what you can do, and the lower row displays the current state of settings or what you have done.

VIEWFINDER DISPLAY – OVERVIEW

Typical viewfinder display. Note the LEDs will only be visible when activated (by the camera or a setting).

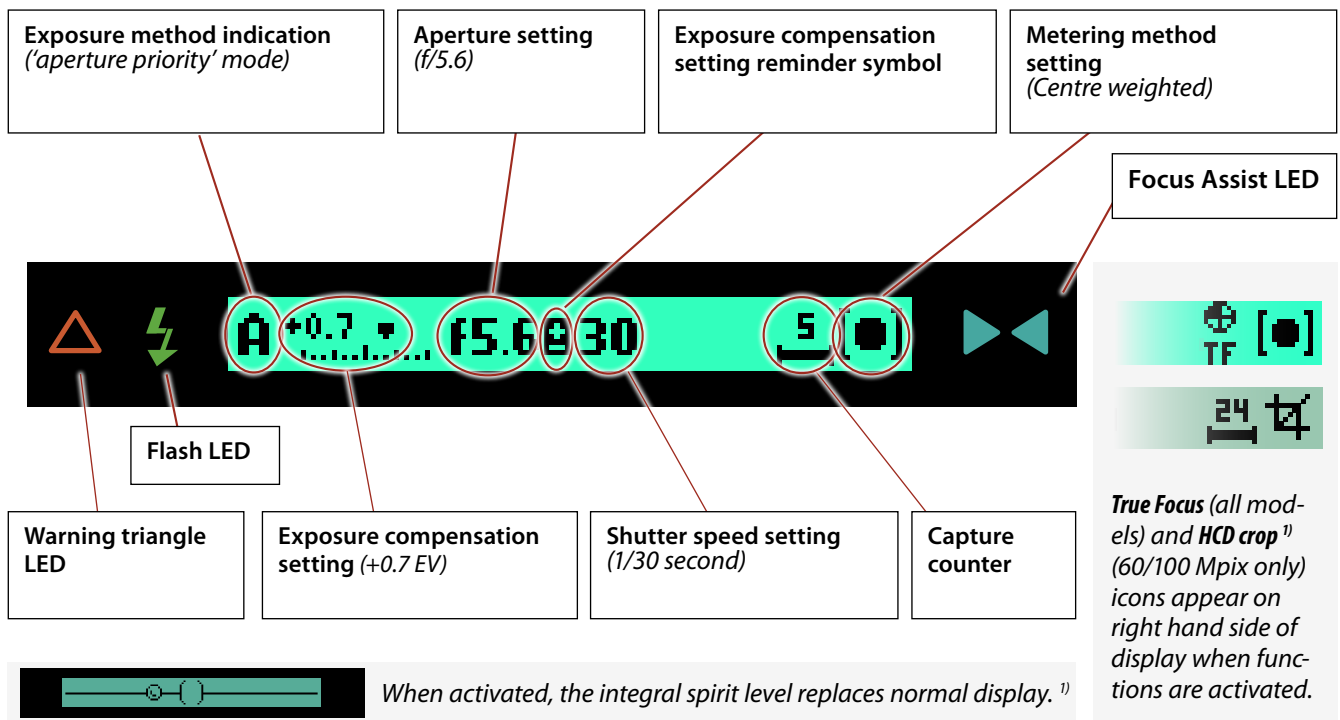

¹⁾ for use with H5D/H6D sensor units only

SOME EXAMPLES OF VARIOUS VIEWFINDER DISPLAYS

Standard settings

Normal screen with True Focus activated: **A +0.0+ f5.6 350 TF [●]**

Normal screen with AE lock activated: **A +0.0+ f5.6 20 [●]**

Normal screen with exposure compensation set: **A +1.0+ f5.6 10 [●]**

Navigation mode

Display when scroll wheels and navigation button is used or when Browse mode is activated.

VIEWFINDER DISPLAY ACCORDING TO SETTING

Menu mode

Flash mode

- [-0.0 Ev Flash Normal
- [-1.0 Ev Flash Normal
- [-0.0 Ev Flash Rear

AF mode

- Manual AF
- Continuous AF
- Single AF
- True Focus AF

EXPOSURE INFO ON VIEWFINDER DISPLAY

Exposure and metering mode examples

- A** EXP [●]
- S** EXP [●]

A = Aperture priority
S = Shutter priority
P = Program
Pv = Program (variable)
M = Manual

Centre Weighted = [●]
 CentreSpot = [●]
 Spot = [●]

Exposure compensation mode

EXPOSURE ADJUSTMENT [-0.3 Ev

REASSIGNABLE GRIP BUTTONS - FUNCTION OPTIONS

These four grip buttons by default are assigned according to name but can be reassigned (in Custom Options #4, #5, #6 and #7 or by using the Camera Configuration tool in Phocus) to various other functions listed here.



- 1 True Focus
- 2 AE-L
- 3 M.UP
- 4 STOP DOWN

- **True Focus**
Temporarily activates True Focus function.
- **AE-lock**
Temporarily locks a light reading in auto or manual modes. Also used in Zone metering.
- **Mirror up**
Locks mirror up for vibration reduced captures. Also lowers mirror.
- **Stop down**
Activates stop down function for depth-of-field checking.
- **AF**
Temporarily activates Autofocus function.
- **Self timer**
Sets self timer mode. Provides a timed remote shutter release function with the option of a change in sequence of the mirror movement (to reduce vibration).
- **Bracketing**
Sets Bracketing mode. This function provides an automatic series of captures; one at the standard exposure setting (Manual or Auto) and the others with predetermined deviations in EV from the standard exposure.
- **B mode**
Sets B mode shutter setting. Shutter stays open as long a pressure is maintained on shutter release button.
- **T mode**
Sets T mode shutter setting. Shutter stays open after first press of shutter release button (toggle function to close again).
- **Flash Measure**
Activates manual flash measure function.
- **Interval timer**
Activates interval function start screen.
- **Cycle Light Meter mode**
Selects next light metering mode.
- **Expose**
Provides alternative to shutter release button.
- **Display Off**
Activates Display Off mode immediately.
- **Histogram**
Provides a histogram on the grip display for the last capture.
- **Focus Conf.**
Provides a 100% preview on display for focus checking. *Not available for True Focus and AE-L buttons.*
- **Delete**
Direct access to delete dialogue.
- **Grey balance exp.**
Provides selective capture for grey balance calculations.
- **Spirit Level**
Activates spirit level on back and in viewfinder. Only for use with H5D or H6D sensor units.
- **Rear Info Screen**
Activates grip information on sensor unit display.

SHORTCUT ACCESS TO BUTTON SETTING SCREENS

- 1) Press the **MENU** button followed by the button you want to reassign (**True Focus, AE-L, M.UP** or **Stop Down**). This directly accesses the particular button you chose at the Custom options level in the menu.
- 2) Rotate the **REAR scroll wheel** to select the function you want the button to activate.
- 3) Press **SAVE** (or the shutter release button). The selected button will now activate the newly assigned function directly.



SHORTCUTS

Some buttons access shortcuts if used in different ways or contexts.



- 1 Shutter release button** – *Camera activation*
Re-activates camera from **Display Off** mode.
- 2 Shutter release button** – *Quick save*
Half-press shutter release button to make a quick save when making settings adjustments.
- 3 Front scroll wheel** – *Menu navigator / Browser*
Functions as a horizontal navigator on sensor unit menu as well as a capture browser in **Browse** mode.
- 4 Menu button** – *Custom Options access*
Press **MENU** button twice on the grip to access the latest setting made in *Custom Options*. After making any changes, press the shutter release button to save the new setting.
- 5 Menu button** – *Customizable Button access*
Press **MENU** on the grip and then the desired customizable button (**True Focus**, **AE-L**, **M.UP**, **Stop Down**) to access the choices available in *Custom Options*. After making any changes, press **SAVE** or the shutter release button to save the new setting.
- 6 Profiles button** – *Camera activation*
Re-activates camera from **Display Off** mode.
- 7 Rear scroll wheel** – *Menu navigator*
Functions as a vertical navigator on sensor unit menu.
- 8 True Focus button** – *Camera activation*
Re-activates camera from **Display Off** mode.
- 9 True Focus button** – *Zoom-in button*
Automatically acts as **Zoom-in** button when in **Browse** mode.
- 10 True Focus button** – *Selection button*
Automatically acts as value selector on sensor unit menu when in **Menu** mode.
- 11 CF Card format button** –
Formats the current inserted CF card (requires confirmation) – *for use with HSD sensor units only.*
- 12 AE-L button** – *Camera activation*
Re-activates camera from **Display Off** mode.
- 13 AE-L button** – *Zoom-out button*
Automatically acts as zoom-in button when in **Browse** mode.
- 14 AE-L button** – *Selection button*
Automatically acts as value selector on sensor unit menu when in **Menu** mode.
- 15 Mirror Up button** – *Camera activation*
Re-activates camera from **Display Off** mode.
- 16 Stop Down button** – *Camera activation*
Re-activates camera from **Display Off** mode.

GENERAL



Photo: Ken Hermann © / Hasselblad Masters

■ CARRYING STRAP

The carrying strap is attached by firstly withdrawing the safety collar. The hook is then freed and can be attached to the strap lug. Slide back the safety collar to ensure the hook remains in the locked position between the small protruding lugs. The collar is purposely a tight fit to avoid unintentionally slipping back and therefore might need some effort to slide.



■ RECHARGEABLE BATTERY GRIP

The environmentally approved **Battery grip Li-ion** (3043357) is the standard power source for the H6X camera. The H6X requires a power supply for all actions as there is no mechanical reserve facility. When working untethered, it is therefore advisable to keep a reserve rechargeable battery grip at hand. As is the case with most batteries, problems might be encountered when used in very low temperatures. In this situation it is advisable to keep the reserve battery in an inside pocket, for example, to maintain it near body temperature.

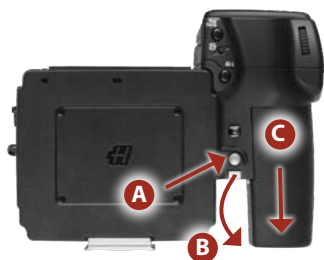

■ FITTING AND REMOVING A BATTERY

The fitting and removing procedure is the same for both types of battery grip.

Remove the battery from the camera by depressing the battery holder button (A) and simultaneously swinging the battery holder retaining lever (B) down until it stops. Pull the battery downwards (C).



If you intend to store the battery separately from the camera you should ensure that the safety cover is in place (to prevent short-circuiting). It snaps into place and is removed by pulling outwards and upwards on the locking clip.



To fit, hold the battery flat against the camera body and aligning the two upper lugs with the slot, slide it back into position as far as it will go. Swing back the battery holder retaining lever until it clicks back into place.

■ BATTERY CHARGER

The battery charger is supplied with a number of plug attachments to suit various types of domestic electrical sockets available worldwide. Other types of socket will require a domestic socket converter.

Attach the chosen plug by sliding it into position as in the diagram. Removal is by the reverse procedure.



Please note that the **Battery charger Li-ion 2900** (3053572) is designed for use with **Battery grip Li-ion 2900** (3043356) but can also be used together with the **Battery grip rechargeable 7.2V Li-Ion** (3043348) intended for H4D use.

Likewise, the older **Battery charger for Li-Ion battery** (3053568) also can also be used together with the **Battery grip Li-ion 2900** (3043356) but requires 50% longer charging times.



■ CHARGING THE BATTERY

With the battery removed from the camera, insert the jack plug from the battery charger into the socket on the battery grip. Insert the battery charger into a standard (100–240V~/50–60 Hz) domestic socket.

During the charging procedure, the lamp on the charger signifies the following:



Note
It can take about 6 hours to charge the battery completely the first time.

■ RECHARGEABLE BATTERY GRIP LI-ION/ BATTERY CHARGER LI-ION 2900 – PRECAUTIONS & GENERAL

- The battery should be charged for approximately 6 hours before first time use.
- The battery must be charged at room temperature.
- Maximum battery capacity is reached only after the battery has been charged and discharged several times.
- Avoid frequent full discharges (a full discharge is signalled by the appearance of the Replace battery warning on the grip display). As the battery is a Li-ion type, it has no 'memory effect' of practical importance and therefore frequent recharges will cause no problems such as loss of capacity or poor performance. It is therefore better policy to recharge the battery at very regular intervals, regardless of use.
- Remove the battery if you intend to store the camera for some while as it will eventually become completely drained, even though the camera is turned off.
- The battery has an integrated 'fuel gauge' capability that supports the Replace battery and Battery status functions on the grip display. As with most Li-ion batteries, this capability should be occasionally calibrated, depending on how much the battery is used. To do this, leave the camera on (or use it), until the Replace battery warning appears. Then, recharge the battery for 6 hours. This will improve the accuracy of the measurements.
- When removing a battery from the charger and immediately replacing it with another, allow a few seconds to elapse so that the charger can automatically reset for the next charging procedure.
- It is perfectly normal for the battery to become warm when being charged.
- A slight temporary loss of battery performance might be noticed at very high or low temperatures. Take the appropriate measures if this is the case.
- If you do not intend to use the battery for a while, it is best to store it at room temperature with an approximate 30 to 40% charge. You can check the percentage level on the status screen.
- The battery should have a usable service life of around 400 recharge/discharge cycles.
- Connect the battery grip to the camera correctly.
- Keep the protective cover in place when not in use. (Short-circuiting across keys in a pocket, for example, could cause a fire risk).
- Do not immerse the battery grip in liquids.
- Do not incinerate the battery grip. Please recycle or discard in an environmentally approved manner.
- Use indoors only (protect against moisture).
- Do not short-circuit the jack plug.
- Do not alter the charger in any way other than changing the plug attachment.

Tip
You can save battery consumption by changing the Power mode setting.

■ BATTERY LIFE & BATTERY WARNING

Battery life is dependent on a number of variable factors and therefore cannot be exactly predicted. If the camera is left in the active state instead of *Display Off* or *Sleep* modes for long periods, for example, then the battery will become exhausted much faster. A low camera battery state is indicated by a symbol on the grip display, in the viewfinder as well as on the sensor unit display. In addition, an audible signal sounds.

When the battery is almost completely exhausted, a warning message **Replace battery** will appear on the grip display.



Quick visual check



Exhausted battery warning

Note

When the low-battery message in the viewfinder appears, the camera automatically enters a temporary power-saving mode. This is recognizable by a slower pace for all the actions in a capture sequence. The camera actions also sound differently.

This mode is designed so that you can continue working for a while, even though the power remaining in the battery is too low for working in the normal manner. Normal action automatically returns with a refreshed battery.

BATTERY STATUS

An immediate full-screen information and battery status check appears on the grip display by holding down the illumination/battery status button. This screen displays:

- the firmware version
- the number of captures taken since the last battery recharge / change.
- a rechargeable-battery status icon that provides a quick visual check as well as a figure estimate in percent.



The information regarding the number of captures taken is intended to help you make an estimate of the number of possible remaining captures according to your way of working. For example, if you regularly browse a great deal when shooting or you leave the camera in ON-mode instead of *Display Off* or *Sleep* modes, you would naturally expect to drain the battery sooner than others who don't. You should soon be able to build up a picture of how you usually work and can therefore estimate that after X number of captures, you normally expect to be able to take Y captures before the battery is exhausted (when working in a similar manner in similar conditions).

The percentage information, however, provides another kind of estimate based more on the amount of charge left in the battery rather than on your normal way of working.

Remember that these are only estimates and that there are a number of factors affecting remaining battery charge, ambient temperature for example, as well as general practice.



POWER MODES

The H6X can be set at three active modes – **ON**, **Display Off** and **Sleep**. In these active modes, battery consumption is least in **Sleep** mode and most in **ON** mode. Both the grip and the sensor unit displays are dimmed accordingly. However, after a set number of minutes of complete inactivity, the whole camera can automatically enter another mode (custom setting) to conserve power (indicated by no visible logos on either display).

ON

To activate the camera press the red **ON.OFF** button until you see the start-up H6X logo appear on the grip display. The logo is automatically followed by the main screen.

OFF

From the active screen, press (not click !) the red **ON.OFF** button for a half second. All buttons (except the **ON.OFF** button) remain ineffective, producing virtually no demand

on the battery. This is the normal mode when transporting or storing the camera or where there might be a risk of inadvertently activating the camera. (However, remove the battery grip if you are going to store the camera for a period of more than a few weeks).

In this mode neither the viewfinder display nor grip display information is available.

RE-ACTIVATION FROM DISPLAY OFF OR SLEEP MODES

- press the shutter release button half way
- press the Stop down button
- click the **ON.OFF** button
- press the Mirror up button.

VIEWFINDER SCREEN

The H6X is fitted with a Spherical Acute-Matte D viewfinder screen for extreme brightness, clarity and even illumination. An optional accessory screen with a grid pattern is also available.

To change a viewfinder screen, remove the viewfinder to access the viewfinder screen. To remove the screen, place the tip of a ballpoint pen or similar in the viewfinder screen removal lug and pull upwards. To replace the screen, position the right side of the screen in place so that it sits correctly in the recess. Place the tip of a ballpoint pen or similar in

the viewfinder screen replacement indentation and press downwards until the screen snaps into position. Try to avoid touching either surface of the screen with bare fingers.



Note

Do not attempt to clean the screen by immersing it in water, or use any kind of cleaning fluid. If the screen becomes damp, do not use hot air to dry it. Use a soft cloth on the upper surface only. Seek advice from an Authorized Hasselblad Service Center if the screen becomes particularly soiled. Remember that particles or greasy marks on the screen might impair the viewfinder image but have no effect whatsoever on the recorded image

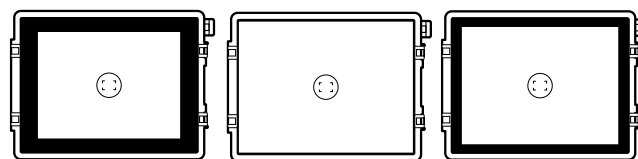

Viewfinder screens showing the difference in masking and composition frame marking. Type varies according to sensor size. See under Accessories for other types (with grid pattern, for example).

REMOVING AND ATTACHING A SENSOR UNIT

Attachment

1. Remove a FireWire cable if connected.
2. Position the retention groove on the sensor unit onto the retention bar on the camera body ensuring that they are correctly positioned. Swing the sensor unit towards the camera body and firmly press into place with a click. If there is resistance, the magazine retaining catch on the camera has probably been inadvertently released. In that case, push the release button again to reset the catch.

Removal

1. Rotate the sensor unit release button **A** to the right, and while maintaining that position press the centre of the button firmly inwards towards the camera body **B** to release the sensor unit.



PROTECTIVE BASEPLATE

To remove the protective base plate, lift the securing catch while pushing the plate towards the lens. To attach it again, slip it over the camera foot until it stops and the securing catch snaps into place.

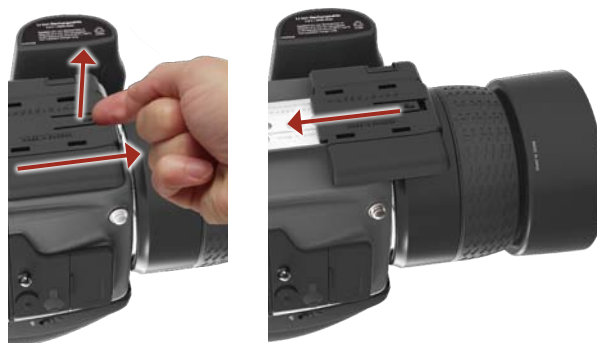

REMOVING AND ATTACHING A VIEWFINDER (OPTIONAL ACCESSORY)

To remove, grasp the viewfinder in the right hand and while depressing the viewfinder release button, lift the rear of the viewfinder up and away from the camera body.

To attach, hold the viewfinder at a slight angle and rest it on the top of the camera. Slide the viewfinder forward until the front locating pin is in position in the recess in the front edge of the viewfinder screen aperture on camera body. Press the rear part of the viewfinder firmly downwards until it clicks into place.

Ensure that both sides of the viewfinder are seated correctly and that it has been firmly attached and locked into position. Failure to do so could cause an intermittent malfunction if the databus interface connections between the viewfinder and camera body are not positively secured. Avoid lifting the camera by the viewfinder alone.



EYEPIECE ADJUSTMENT

No corrective lenses are needed to adjust the eyepiece to suit most requirements. The diopter range is from -5 to +3.5D. Eyeglass wearers can rapidly and accurately change the settings according to whether they wish to wear eyeglasses for viewing or not.

Personal eyepiece adjustments can be carried out by pointing the camera at the sky or similar smoothly toned area. While holding the camera in your left hand, you can with your right thumb turn the adjustment wheel until the markings on the viewfinder screen reach the optimum sharpness for your eyesight.

If you normally wear eyeglasses for distance viewing and intend to wear them for camera use then do not remove them for the above procedure. If, on the other hand, you prefer to remove your eyeglasses for camera work, then repeat the above procedure without wearing your eyeglasses.



RUBBER EYE CUP

Two rubber eye cups are available for the H6X. The one supplied is suitable for users who do not intend to use eyeglasses when photographing. The second shorter eye cup is for those who either prefer to position their eye further from the viewfinder and those who wish to wear eyeglasses.

The eye cups can be rapidly changed by a Hasselblad Authorized Service Center.



ACCESSORY CONNECTION

There are two accessory-retaining screw threads (M5) as well as a databus connector on the left hand side of the camera body, protected beneath a cover.

The cover can be removed by firstly lifting the left hand edge a little and then sliding the cover to the left, as in the illustration.



Lift this edge of the cover first

PC-CONNECTOR

A PC connector for non TTL-flash synchronisation is located on the left side of the body. It is protected by a captive rubber plug.



HM 16-32 FILM MAGAZINE (OPTIONAL ACCESSORY)



Photo: Denis Rouvre © / Hasselblad Masters

■ HM 16-32 FILM MAGAZINE (OPTIONAL ACCESSORY)

The Hasselblad HM 16-32 film magazine is a sophisticated semi-independent unit within the H system. It has its own power supply for individual information storage, LCD panel, illumination, etc. It features: automatic 120/220 compatibility, automatic wind on/wind off, automatic film advance, LCD information panel, integral darkslide, customizable data imprinting, illuminated LCD, barcode recognition, count-up or count-down film frame reminder choice and multi shot option.

Much information is transmitted and received between the magazine and the camera body, so ensure the databus connection is kept clean and not damaged in any way. It is advisable to fit the magazine protective cover when storing a film magazine to protect both the databus connection and the darkslide.



■ PARTS AND COMPONENTS

- 1. LCD panel
- 2. LCD illumination button
- 3. Change up button
- 4. Change down button
- 5. Function selector
- 6. Film plane index
- 7. Darkslide key
- 8. Darkslide indicator
- 9. Film tab holder
- 10. Film holder key
- 11. Magazine settings lock
- 12. Databus interface

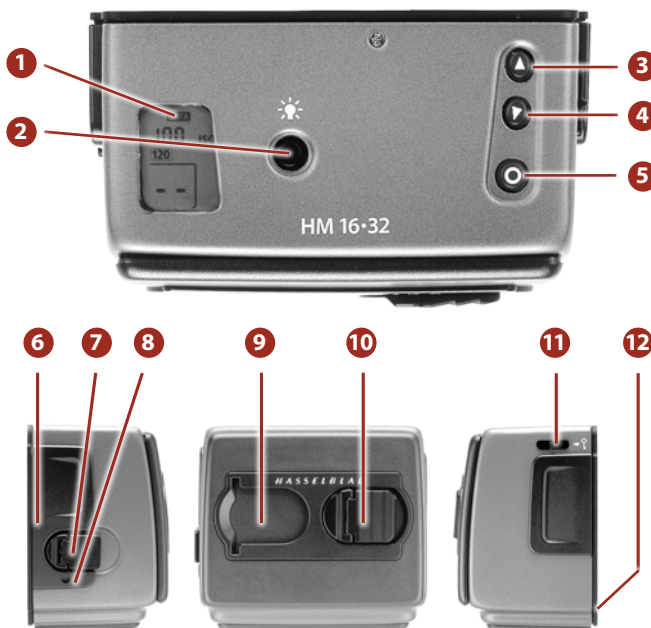

■ LCD PANEL

The various functions are accessed by repeatedly pressing the function selector button (loop menu) and changes made by the 'change-up' and 'change-down' buttons. Any settings are automatically saved. At very low temperatures the LCD will require a few seconds to display new settings.

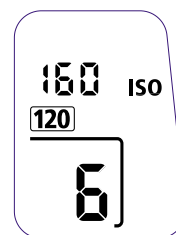

■ LCD ILLUMINATION BUTTON

The LCD can be illuminated by pressing the display illumination button, which is accessible when the magazine is not attached to the camera. The LCD will remain illuminated all the time you keep the button depressed, up to a maximum of 10 seconds. After 10 seconds has expired, you must release the pressure on the button and press again to obtain a further 10 second period of illumination. Remember that using the illumination function very often will noticeably shorten the life of the battery in the magazine.

When the magazine is attached to the camera, the button on the magazine is inaccessible but you can still illuminate the LCD by pressing the illumination button on the grip instead.

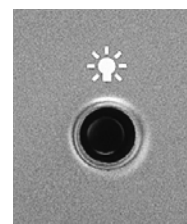

■ CHANGE UP /CHANGE DOWN BUTTON

Can alter the settings 'upwards'. For example, to increase the film speed setting. Toggle action.

Can alter the settings 'downwards'. For example, to decrease the film speed setting. Toggle action.



■ FUNCTION SELECTOR

Selects the four functions that can be changed on the magazine. The functions are on a menu loop so that repeated pressing of the selector button will successively access all functions in turn. After a time-out of five seconds of non-activity, the display returns to the main screen.

NOTE: Changes can only be made when the settings lock switch is in the unlocked position.

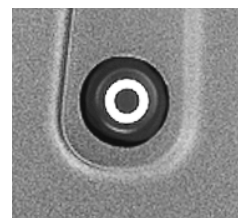

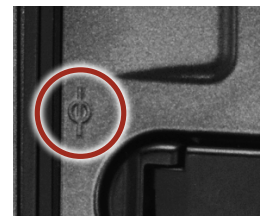

■ FILM PLANE INDEX

Provides a measuring point for the actual position of the film plane in the magazine. Used for calculations in critical applications.



■ DARKSLIDE KEY

Withdraws and replaces the darkslide. Fold out the key and turn it counter-clockwise 360° (towards the open  symbol) to withdraw it and clockwise 360° (towards the closed  symbol) to replace it.

NOTE: The darkslide can only be withdrawn when the magazine is attached to the camera.



■ DARKSLIDE INDICATOR

Indicates whether the darkslide is in place or withdrawn:

RED = **stop!** = exposure **CANNOT** be made
(magazine can be removed from camera)

WHITE = **ok!** = exposure **CAN** be made
(magazine cannot be removed from camera)

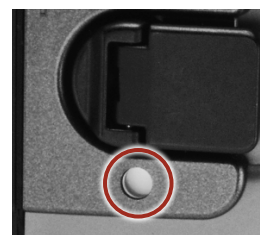

If you attempt to make an exposure when the darkslide is closed, however, you will receive a warning message in the viewfinder and grip LCDs – 'The darkslide is closed'.

■ FILM TAB HOLDER

Holds an ID tab from the film roll pack as a reminder of the type of film loaded. *Remember to change it if you change film type!*



■ FILM HOLDER KEY

Secures the film holder in the magazine. Fold out the key and turn counter-clockwise 90° to remove the film holder and turn clockwise 90° to lock the film holder in place.



■ MAGAZINE SETTINGS LOCK

All settings can be locked to avoid inadvertent changes. To change the settings, slide the settings lock (see illus) to the right until it stops. After the changes have been made, slide the settings lock to the left (see symbol on magazine) again to secure the new settings.



■ DATABUS INTERFACE

Data interface between magazine and camera. Ensure the contacts are kept clean and protected from damage. Keep the protective cover on when the magazine is being stored or transported.



■ BATTERY

The magazine uses a battery to retain information and settings when unattached from the camera. When attached to the camera body, the magazine takes its power requirements from the camera batteries. The magazine battery will normally be effective for 1-2 years depending on use (off camera illumination, for example). When the battery is in a very low condition, (approx. 1 month of use left), a low-battery symbol appears on the magazine LCD as a warning. The magazine will continue to function with no battery power left as long as it remains attached to the camera body. However, when detached, the settings will not be stored.

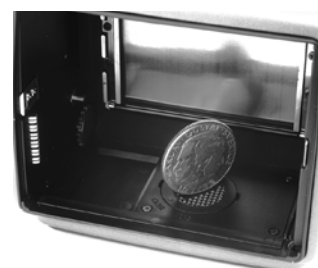

■ BATTERY REPLACEMENT

Release the film holder by folding out the film holder key and rotating it 90° in a counter-clockwise direction. Withdraw the film holder completely. On the bottom plate on the inside of the film magazine housing you will find a slotted circular battery cover. Insert a small coin or similar into the slot and rotate the cover about 20° in a counter-clockwise direction. The cover will be freed and the battery can be removed. Replace with a fresh CR2032 / 3V lithium (or equivalent) battery. Observe the polarity and ensure the positive (+) face is uppermost and replace the cover (ensure the retaining lugs are inserted in the battery compartment slots), locking it into place by rotating it in a clockwise direction until it stops. If you inadvertently insert the battery incorrectly, the film magazine will not be damaged though it will not function. Try to avoid touching the surface of the battery with your bare fingers as sweat residue can decrease the electrical conductivity of the battery casing and might cause corrosion.



After battery replacement, the magazine's parameters return to the default settings (Barcode, 120, Data-on, Count up).

■ ATTACHING AND REMOVING THE MAGAZINE

You cannot remove a magazine from the camera body if the magazine darkslide is not in place, (when the magazine darkslide indicator on the magazine shows white). Neither can you withdraw the magazine darkslide when the magazine is not attached to the camera. Both these restrictions therefore prevent accidental film loss caused by fogging.

Attachment

Position the magazine retention groove onto the magazine support on the camera body ensuring that they are correctly positioned. Swing the magazine towards the camera body and firmly press into place with a click. If there is resistance, the magazine retaining catch on the camera has probably been inadvertently released. In that case, push the release button again to reset the catch.

You can attach and remove the magazine with or without the film holder in place. If you just want to change to a new film, you can remove and reload the film holder without having to remove the whole magazine.

Removal

Ensure that the darkslide indicator on the magazine shows red (signifying that the darkslide is closed). Firstly rotate the lever of the magazine release button to the right (fig. 4/1) and while maintaining that position press the centre of the button firmly inwards towards the camera body (fig. 4/2) to finally release the magazine.

- Ensure you press on the centre of the button.
- You cannot remove a magazine if the darkslide is not closed.
- If the film holder is inadvertently removed mid-film, then exposed frames will naturally be lost due to light fogging. However, if the film holder is re-inserted, the film will automatically be advanced by three frames to position fresh unexposed film. The film counter will also correspondingly add on three frames to the original number recorded before the film holder was removed.



■ SETTINGS

Press the function selector ( button) repeatedly to successively access:

- Film speed (ISO / Bar Code)
- Film length (120/220/ Number of frames)
- Data (on/off)
- Frame counter (count down / count up)
- Low-battery warning symbol

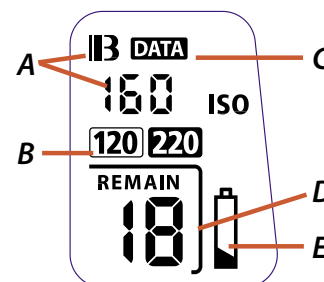



FILM SPEED SETTING / BARCODE

The film speed (ISO / ASA) can be set automatically or manually. Automatic setting uses a Barcode (only some films have this feature, notably Fujifilm). This is the default setting.

Film settings (ISO / film length) are automatic only if the magazine is set at Barcode automatic. That is, a bar-coded film cannot override a manual film speed setting but a manual setting can override the film speed of a bar-coded film.

Films without a barcode must have their speed set manually. A manual setting must also be made if you want to override the speed setting of a bar-coded film.

To access Manual setting:

- 1) Ensure the magazine settings lock is in the unlocked position.
- 2) Press the  button until a figure (or barcode symbol) appears together with ISO.
- 3) Press either the  or the  button to reach the required setting.
- 4) The new setting will be saved automatically after a time out of five seconds.
- 5) Return the LCD settings lock to the locked position.

NOTE: If you use both standard and bar-coded films (or overridden bar-coded films), check that you have changed the settings accordingly.

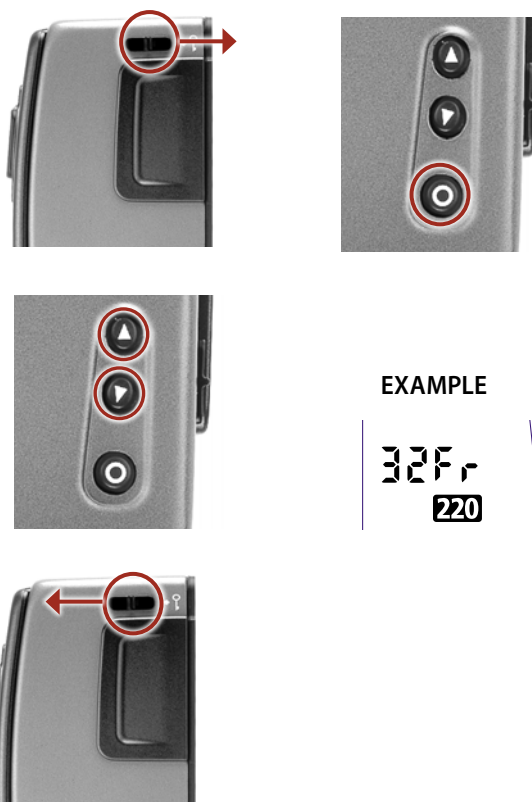



FILM LENGTH/NUMBER OF FRAMES

Both 120 and 220 films can be used. 120 film will produce 8 (for use with 'half-length' 120 films only) or 16 frames and 220 film will produce 32 frames.

If the film has a barcode, then film length setting (and film speed setting) is automatic. The LCD will automatically show the barcode symbol and the appropriate film length. (Note that film speed can be overridden with bar-coded films, but not film length).

If, however, the film has no barcode then proceed as follows:

To access film type setting:

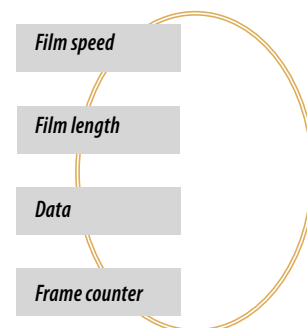

- 1) Ensure the magazine settings lock is in the unlocked position.
- 2) Press the  button until the 120 or 220 symbol appears.
- 3) Press either the  or the  button to change the desired setting.
- 4) The new setting will be saved automatically after timeout.
- 5) Return the magazine settings lock to the locked position.



■ DATA IMPRINT SETTING

Data imprinting can be activated or deactivated through the magazine menu.

To access data setting:

- 1) Ensure the magazine settings lock is in the unlocked position.
- 2) Press the  button until the Data symbol appears.
- 3) Press either the  or the  button to reach On or Off.
- 4) The new setting will be saved automatically after a time out of five seconds.
- 5) Return the magazine settings lock to the locked position.

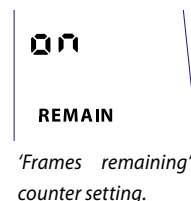



NOTE: Operation and changes made to the data imprinting function are accessed through the camera menu. Please see separate section for full details.

■ FRAME COUNTER SETTING

The frame counter can be set to show either how many unexposed frames remain on a film or how many frames have already been exposed. The LCD shows your choice of setting by adding the word Remain as a reminder of the number of frames remaining or 'countdown'. Absence of this word implies the opposite, namely, 'count-up', so it denotes the number of the next frame to be used (for example, the figure 4 means three frames have already been exposed). This information is also automatically displayed on the grip LCD and viewfinder LCD though only as a figure above a symbol.

To access frame counter setting:

- 1) Ensure the magazine settings lock is in the unlocked position.
- 2) Press the  button until Remain appears.
- 3) Press either the  button or the  button to reach the desired setting (toggle function).
 'on' will show the number of frames remaining on the roll.
 'oFF' will show the number of the next frame in the series.
- 4) The new setting will be saved automatically after a time out of five seconds.
- 5) Return the magazine settings lock to the locked position.

■ LOW-BATTERY SYMBOL

The low-battery symbol only appears on the magazine LCD when the battery needs changing.

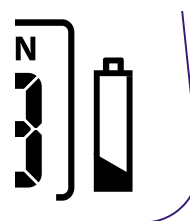

■ EXAMPLE

In the example shown here:

- 120 film length set manually
- the film speed (ISO160) has been set manually
- 5 frames have already been exposed (therefore with regular 120 film, 11 frames remain)
- the battery is functional

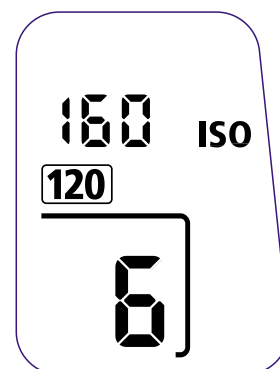

FILM LOADING

The film magazine can be loaded either on or off the camera. Regularly check the interior of the magazine and remove dust, particles or any scraps of paper from previous rolls of film. Load and unload film magazines away from direct light sources.

- 1) Fold out the film holder key and turn it counter-clockwise 90° **A**. Withdraw the film holder completely **B**.
- 2) Place an empty take-up spool in the upper spool holder by placing one end over the fixed stud in the holder and the other end underneath the sprung spool retaining arm. Rotate the spool a little if necessary until it clicks into position.
- 3) Completely remove the retaining paper band from a new roll of film and place it in the lower spool holder. See diagram for correct orientation. Ensure you do not place the film spool the wrong way around!
- 4) Pull 8–10 cm (3–4 in.) of paper backing from the film roll and insert the tongue of the backing paper into the slot in the take-up spool. Turn the spool one complete turn to ensure the tongue is firmly held in place by the overlying paper backing.
- 5) Re-insert the film holder into the main body of the film magazine ensuring the correct orientation. Press firmly inwards towards the magazine and pay particular attention to see that both sides are level with the magazine body **A** before turning the film holder key clockwise 90° to lock the film holder in place and fold the key back into its stored position **B**. You might find that increased pressure on the left hand side of the film holder will more easily ensure a positive and correct positioning in the magazine.

If the camera is active or in standby mode the film will be wound automatically by the camera to position the first frame (this function can be changed in 'Custom options' so that the film is advanced only when the shutter release button is pressed the first time).

Beeper

The beeper sounds immediately after the last-but-one frame has been exposed. This function can be turned off in Custom Options.



FILM WIND ON AND OFF

Wind on: See 'Film wind-on' under Custom Options for a setting choice.

Wind off: When the last frame has been exposed, the film will automatically be wound off. However, to wind off a film sooner, press the film wind off button (fig. 6). Use a ballpoint pen or similar to activate it. You must also confirm the message on the grip LCD (fig. 7) before the film winds off.



UNLOADING A FILM

To remove a film, remove the film holder in the same manner as when loading a film. Grip the exposed roll of film firmly and remove. Ensure the paper backing is wound tightly and that it is sealed with the band properly (the band may need to be moistened to activate the adhesive depending on type). Store exposed films away from strong light sources and contact with sharp objects. Move the remaining empty spool to the take-up spool compartment.

DIGITAL



Photo: Frank Meyl © / Hasselblad Masters

■ NOTE

This section is only about the workflow with compatible Hasselblad digital backs. (CFH, iexpress CF, H5D and H6D sensor units)

■ FORMATTING CARDS

New cards sometimes have no formatting, or you might want to convert a card that is currently using a format that the sensor unit cannot read. In either case, you should reformat a CF card in the sensor unit for H6X use.

■ FORMAT BUTTON – for use with H5D and H6D sensor units only

Press the **Format** button on the camera grip. It is purposely recessed to avoid unintentional use, so use a ball-point pen or similar. A prompt is displayed on the sensor unit for confirmation.



■ HASSELBLAD CAPTURE FILES, PHOCUS & ADOBE/APPLE SOFTWARE WORKFLOWS



Hasselblad RAW files are initially stored in the 3FR format which is a proprietary Hasselblad format for the temporary storage of captures. A 3FR file contains the complete digitized raw image exactly as it was captured by the camera. 3FR information requires further computing power (typically by way of Phocus) to obtain complete development. If developed in Phocus, 3FR files become Hasselblad 3F files – denoted by each file now bearing the suffix “.fff”. If developed by other RAW processors, the 3FR files are not converted to 3F but can be exported directly to TIFF, PSD etc according to requirements.

However, when working tethered – which necessitates using Phocus – 3FR files are automatically processed and stored in the background on a computer appearing as 3F files on the hard disk ready for selective adjustment and export. 3FR files stored on a CF card can be processed to completion using:

- *Hasselblad Phocus*
- *Adobe Camera Raw / Lightroom*
- *Apple Aperture / Photos*

To sum up, capture files can be stored as 3FR files (from a CF card) for later processing in Phocus or other software, or they can be stored as 3F files (as a result of tethered shooting or 3FR files processed and converted in Phocus). In all cases if you keep the original 3FR/3F files, you will also retain the possibility of reprocessing them in the future in later versions of Phocus or other software to take advantage of eventual improvements and developments.

Note that using Phocus is the most comprehensive method. The Phocus and Adobe methods can produce almost identical results (in most cases, but not all) regarding RAW conversion so it is a matter of personal choice regarding which method would best suit your preferred ways of working. Alternatively you can use Apple Aperture though you should take note that the benefits of DAC and HNCS etc, will be lost in this case.

Mixed formats

Phocus can also process most other capture formats, generic and proprietary. This means you can include other formats in your normal Phocus workflow if you choose. Or if you prefer, you can include Hasselblad files in Adobe / Apple workflows as stated above.

PHOCUS

Phocus is the capture processing and file management application aimed primarily at Hasselblad 3F file handling. Phocus Mobile offers remote viewing and control when shooting tethered while Phocus Quick offers a very rapid and simplified file processing capability.

Phocus allows the extraction of the most detailed files from the world's most advanced cameras to your desktop in a professional and efficient manner.

Phocus works the way that photographers work and provide serious photographers with a well thought out, and intuitive workflow, designed to provide maximum power and options with a minimum of effort. Phocus produces ground-breaking new levels of image quality and technical precision and when combined with the world's finest optics and image sensors the result is exactly what you would expect from Hasselblad – simply stunning image quality.

FEATURES IN PHOCUS

Ultimate Image Quality

- Hasselblad Natural Color Solution (HNCS)
- Sophisticated lens corrections for H and V system lenses (DAC)

Specialized Tools

- Advanced Tethered Camera Controls
- Phocus Mobile*
- Scene calibration & reproduction tools
- Leading edge Moiré removal
- Highlight recovery, shadow fill, clarity and dust spot removal tools
- Keystone correction tool
- Selective Adjustments

plus:

- Easy-to-use interface
- Extensive customization options for individual workflow scenarios
- Import/Export of Image Adjustments, Keywords, Workflow settings etc
- High quality printing
- Slide show
- RAW file support from more than 150 DSLR cameras
- License free software (unlimited installations - no registration issues)

Any File from Anywhere!

Phocus allows you to import image files and work in the same intuitive processing environment, no matter where your files are coming from. You can browse, handle, adjust, and process all kinds of RAW and non-RAW formats.

Phocus supports RAW files from more than 150 cameras, including Canon, Nikon, Leica, Sony, Fuji, Olympus **. The most common file formats can be processed for example TIFF, JPEG, DNG, and PNG. "Not all adjustments are available for 3rd party files".



Ultimate Image Quality

Phocus combines with Hasselblad Natural Color Solution (HNCS) and Digital Auto Correction (DAC) to provide ultimate image quality in every image you create. With Phocus, the moiré that can occur on even extremely high-resolution images is effectively removed automatically and directly on the raw data, leaving image quality intact and saving hours of tedious post-production work.

Tethered shooting is also very smooth with Phocus Remote camera controls providing a number of remote functions, such as remote focusing, live view, aperture and exposure time controls, etc.

Phocus Mobile

Phocus Mobile is available for the iPhone®, iPad® and iPod Touch®. It enables you to connect wirelessly to a computer running Phocus and to remotely browse your high-resolution RAW, JPEG and TIFF images.

This provides a handy solution for working with clients in the studio, enabling each person to view images on an individual iOS device, rather than all gathering around a single computer.

Phocus Mobile also allows users to remotely operate and trigger a tethered camera, giving control of many parameters, all neatly presented in a virtual camera display. This feature is very convenient for remote control of the camera when it's located in a difficult-to-access position. Phocus Mobile is available for free download at the App Store.

* Phocus Mobile is available for download on the Apple App Store.

** Full list available at <https://support.apple.com/en-us/HT207972>

LENSES & FOCUS MODES

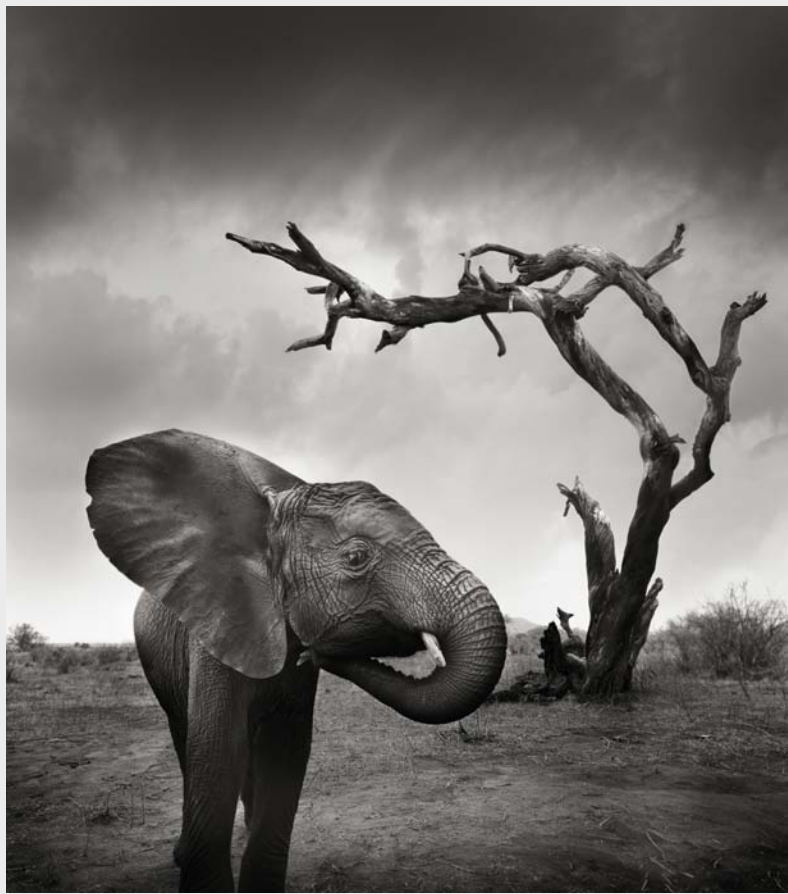

Photo: Joachim Schmeisser © / Hasselblad Masters

■ ATTACHING A LENS

Remove the front protective cover on the camera body by depressing the lens release button and keeping it depressed while turning the cover counter-clockwise. Remove the rear lens cap by unscrewing it in a counter-clockwise direction. Align the index on the lens with the index on the camera body and rotate the lens clockwise (bayonet fitting) until it clicks into place.

■ REMOVING A LENS

Depress the lens release button and keep it depressed while rotating the lens counter-clockwise until it stops and lift it out. Replace protective caps on the lens immediately and on the camera body if necessary.

If you try to rotate the lens before you press the lens release button, it might lock. In this case, rotate the lens clockwise a little first and then re-attempt removal with the correct procedure: button first, then lens.



■ FRONT LENS CAP

Front lens caps are released for removal and attachment by inserting a thumb and index finger into the recesses and pinching in the direction of the arrows.



■ LENS SHADES

All lenses are supplied with lens shades that additionally provide extra protection for transport and storage when mounted in reverse. Lens shades have a bayonet fitting and are turned clockwise into place after ensuring the index on the lens shade aligns with the index on the front of the lens. When mounted in reverse, they are attached by matching the indexes and turning clockwise.



■ SHUTTER AND APERTURE CONTROL

In manual mode both the shutter and aperture are electronically controlled and are adjusted by the scroll wheels on the grip. There are no separate manual setting rings on the lenses or camera body.

The chosen settings are displayed both on the grip display and in the viewfinder display. See under **Light Metering & Exposure Control / Exposure Method** for a complete explanation.



■ FILTERS

Filters have a screw thread fitting (67 / 77 / 95 mm, according to lens) and are screwed clockwise into place. As there is no rotation of the front section of the lens when focus is changed, filters do not rotate either. This is particularly useful when using polarizing or graduated filters where the orientation is normally critical.

■ FOCUSING DISTANCE CALCULATION

There are two distance scales (in feet and metres) visible through the window on the upper part of the lens barrel.

The focusing distance is read off the chosen scale from the central lens index.



Central lens index

■ STOP DOWN / DEPTH-OF-FIELD PREVIEW

A visual depth-of-field preview can be made by depressing the **STOP DOWN** button while viewing the image in the viewfinder.

Depth-of-field can be calculated as follows:

1. Focus the lens as required.
2. Make an exposure reading (auto or manual) and note the aperture setting.
3. Find the markings on either side of the central index that correspond to the chosen aperture.
4. From these two markings, read off on the required lens distance scale the two corresponding distances.
5. The depth-of-field (at that particular aperture and focus setting) will be the area included between these two distances.

In the example given here, the focusing distance is set at nearly 3 metres. At an aperture of $f/22$, the depth-of-field would therefore extend from just over 2 m to approximately 4.5 m. Note that depth of field is not an absolute. Perception of it depends on several factors and so it should be seen only as a rough guide.



■ INFRARED FOCUS SETTINGS

As infrared rays form an image at a different plane to that formed by visible light, the normal focus settings do not apply. Proceed as follows in manual focus mode:

1. Focus the lens in the conventional manner until satisfied.
2. Note the distance setting against the central lens index.
3. Re-align this distance setting against the infrared mark (coloured red) instead of the central lens index.

Alternatively if you have already calculated the required distance, you can make a manual distance setting by using the distance scales together with the infrared mark instead of the central lens index.



For specialists, please contact your Hasselblad dealer for information about sensor units adapted solely for infrared photography.

■ FOCUS ASSIST

As well as the conventional view on the focusing screen to ensure a sharp image, the H6X also features an LED focus assist capability appearing as two arrowheads to the right of the viewfinder display (except for lenses with a maximum aperture of $f/6.7$ or smaller). The arrowheads provide confirmation of a precision focus setting and are a useful aid when making a setting with eyesight alone.

Manual focus setting

When the left arrowhead alone appears it means the focus setting is too far beyond the chosen distance (the area framed within the central zone in the viewfinder) and when the right arrowhead alone appears it means the focus setting is too close. Focus is correct when both arrowheads appear together. If the focus cannot be established, then both arrowheads flash.

Automatic focus setting

Focus is correct when both arrowheads are visible together. Focus is incorrect if only one arrowhead is visible. If the focus cannot be established, then both arrowheads flash.



Lens focus setting too far beyond the distance of the subject framed by the central section in the viewfinder



Focus setting too close for the distance of the subject framed by the central section in the viewfinder



Focus setting correct

Note

Some lenses have extra characteristics that require further explanation. For example, the autofocus range on the HC 4/120 Macro lens can be limited by a specific setting on the camera allowing for near range, far range or full range. This only appears on the grip display together with that particular lens.

Further information can be found in the "H-system Lenses & H-system Lens Accessories" booklet that accompanies each lens. The booklet can also be downloaded from the Hasselblad website.

Also, see note here regarding HCD lenses!

Note

HCD lenses were formulated for use with the smaller size sensors in the H-series, resulting in a reduced coverage for the larger sensors used in 60 Mpix models. So, if you use HCD lenses, be aware of the restrictions (vignetting and diminished quality at the edges).

H5D 60 sensor unit only: As notification of this situation, an auto crop function is employed and an HCD crop icon appears on the right hand side of the viewfinder display when an HCD lens is fitted.

When in Phocus, however, the auto crop function can be turned off in Preferences if you wish.



Note

Lens corrections can be applied when captures are imported into Phocus. Guided by the information in the metadata included with each individual capture, the DAC (digital lens correction) tool uses lens-model specific calculations to adjust for chromatic aberration, distortion and vignetting. Not only model specifications but also capture parameters are taken into consideration for analysis.

This extremely capable refinement of captures should not be overlooked when processing files! See Phocus user manual for details.

Tip

For users who prefer manual focus control but would like the benefits of autofocus, one method is to set the AE-L button (or any customizable button) to AF (Single) drive.

The main subject can then be centered and the AE-L pressed, to ensure correct focus. The camera reverts immediately to manual focus control when the button is released.

Therefore, you can recompose the picture without having to maintain pressure on the release button in order to retain the newly automatically made focus setting (AF-T can also be used).

Tip

The True Focus function can also be combined with other autofocus modes for specific situations.

Note

The autofocus function is not possible with certain combinations of lenses and accessories. However, a warning is displayed which disappears after confirmation.

Tip

To expand your range of lenses, consider using a CF adapter to allow you to use most of the lenses from the Hasselblad V-system.

MANUAL FOCUS

There is both a **Manual** focus mode setting and a manual override capability. **Manual** focus is a specific setting that you actively make, whereas manual override is always available as a temporary override of an autofocus setting.

In **Manual** focus mode, focusing is carried out by rotating the focusing ring in the conventional manner. The focus setting remains until changed as with a conventional non-autofocus lens. This means that pressing the shutter release button will not activate a focus setting change as it does in autofocus. To change back to autofocus, you must make a new setting (by pressing the **AF** button and choosing **AF S** or **AF C**).

With manual override in autofocus mode you can manually alter a focus setting that has been made, by rotating the lens barrel in the conventional manner and without having to change modes. As long as the shutter release button is kept at the half-press position, the new focus setting is maintained. By releasing the pressure on the shutter release button and pressing again, the autofocus function is immediately reactivated.



AUTO / MANUAL FOCUS SETTING

- 1) Press **AF**.
- 2) Turn the **FRONT scroll wheel** to select **Single Shot**, **Continuous**, **True Focus** or **Manual** as required.
- 3) Press **SAVE**.

Natural friction is inherent in the design to purposely reproduce the secure feel of a completely manual lens.

Please note that when focusing manually, the infinity and closest distance marks on the lens scale can appear to be positioned beyond the central index. This is only an apparent effect and does not change the focusing range of the lens.

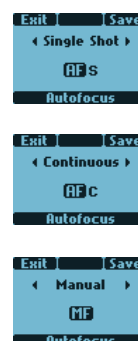

AUTOFOCUS

Autofocus mode can be either **Single Shot** or **Continuous** and is activated by pressing the shutter release to the half-press position. Its operative range is from EV1–19 at ISO100. The point of focus is determined according to the vertical and horizontal areas (see illus) within the central rectangular zone on the focusing screen. When light levels are too low or the contrast of the subject is too low, auxiliary illumination (situated on the top of the grip) is automatically activated if desired. The operative distance is approximately six metres from the camera. Alternatively, a suitable attached flash unit that has a similar facility (a Metz 54/70, for example) can also be used instead. This feature can be altered in settings (**Custom options #16/AF assist light**).

True Focus is also classified as an autofocus function and is normally activated by its own button on the grip. See later section.

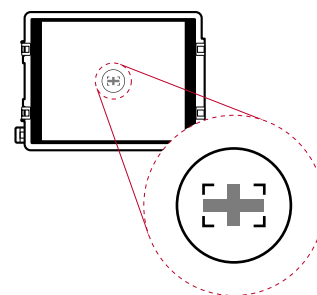

MANUAL OVERRIDE IN AUTOFOCUS MODE

Manual override is always possible in automatic focus mode without any need to make a new setting; just rotate the focusing ring in the conventional manner. As the lens barrel does not rotate in autofocus mode, you can hold the focusing ring for instant manual adjustments as you would with a conventional lens. However, to retain the new manual focus adjustments, you must maintain the pressure on the shutter release button. You can instantly return to the automatic focusing mode by releasing the pressure on the shutter release button first and then pressing the release button half-way again.

The instant manual override function produces a convenient way of working. You can take advantage of autofocus while retaining an instantly adjustable manual focus check if preferred for pin-point accuracy without making any changes in the settings.

AUTOFOCUS OVERRIDE IN MANUAL MODE

See the following section for a description of how to use the advantages of a rapid autofocus check while remaining in **Manual** mode.

■ SINGLE SHOT

At **Single Shot** setting (**AF S**), the shutter release will be blocked until the camera finds the optimum focus setting. This ensures that no captures can be made that are not finely focused. However, this delay will normally be only a fraction of a second in good lighting conditions with a clear focusing pattern.

Note though that in this mode the lens will focus at a distance and will remain focused at that distance while pressure remains on the shutter release button. In this way, you can focus on a nearby object for example, temporarily positioned within the focusing zone on the viewing screen and then without releasing pressure on the shutter release button, recompose knowing that the focus remains on the object chosen even though it is now outside the focusing zone. Releasing the pressure on the shutter release button and pressing again half way would now change the focus setting to the distance of the object within the focusing zone.

See *Manual override in autofocus mode* for a useful way of working with manual and autofocus settings in a combined manner.

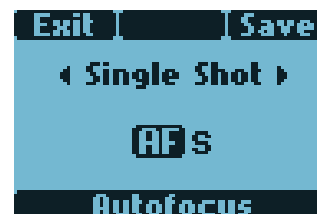

■ CONTINUOUS

At **Continuous** setting (**AF C**), the shutter can be released rapidly before the lens is focused in order to capture a split-second shot (in **Single Shot**, a capture cannot be made until the camera has had time to focus). However, the camera will continue to focus if a moving subject is within the focusing zone or if you recompose, even though the shutter release button is half pressed.

One method to exploit this feature when photographing in a rapidly changing situation is to keep the shutter release button pressed down. In this way the lens focuses constantly (according to the focusing zone) and by momentarily releasing the pressure on the shutter release and then immediately pressing again, you minimize the amount of time needed for the lens to check focus, thus ensuring a split-second shot at optimum focus.



■ TRUE FOCUS

The **True Focus** setting (**AF T**) is generally used in specific circumstances to automatically correct for camera angle/focus setting discrepancies but it can also be combined with other autofocus settings.

To be able to exploit **True Focus** correctly, a few important points should be studied in order to obtain a full understanding of how and when to use it. Basically, there are four variables to pay attention to listed below: (a) proximity of camera to subject, (b) focal length of lens, (c) aperture setting and (d) movement of camera and/or subject after setting. The closer you remain to the ideal situation with regard to these variables, the more noticeable the effect of **True Focus** will be.

- The closer you are to the subject, the worse the original problem becomes. Consequently, the need for **True Focus** solution becomes greater and its application thereby becomes more noticeable.
- Short focal length (wide-angle) lenses naturally decrease camera to subject distances and therefore, following the point in (a), produce a greater need for **True Focus** adjustments.
- Smaller apertures increase the depth of field and therefore would lessen the need for a **True Focus** solution. However, smaller apertures produce a different visual effect, so **True Focus** therefore allows the exploitation of

the shallow depth of field (produced by larger apertures) without the fear of unwanted focus restrictions.

- The calculations involved in **True Focus** use, amongst other things, camera to subject distances to calculate the required amount of adjustment. It therefore follows that if the camera or the subject move after the initial setting has been made, the calculations will not be applicable anymore. So, to ensure the optimum correction, both the photographer and the subject should restrict movement as much as possible. Please note that with some lenses (particularly longer length lenses) just a few centimeters movement can essentially ruin the result.

True Focus can be used with longer lenses, smaller apertures etc but the further you come from situations similar to the 'ideal' as described above, the less the effect will be until it has no visible effect at all. Please remember that although **True Focus** can noticeably improve a demanding shoot it will only work effectively in the specific circumstances it was designed for.

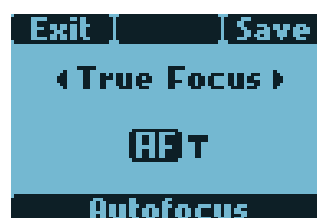

TRUE FOCUS AND ABSOLUTE POSITION LOCK

The obvious situation that would most benefit from using **True Focus** would be a fashion shoot with a fairly wide angle lens at a large aperture setting and where the central area of the image is clothing while retaining focus on the model's face. Ideally, a fairly controlled and static flow should be planned on (this means a change of pose by the model should take place only after captures and the photographer must resist crouching down, or leaning forwards or backwards too much before capture).

With the lens at its widest aperture setting, a normal autofocus setting is made on the model's face (A), and the camera focus locked. The composition is then changed to include more of the clothing (B), but the locked focus setting now extends beyond the model's face at (B) according to the laws of geometry. This will naturally result in an image where much of the subject closest to the camera and the model's face will be unsharp. Solutions involving manual focus/focus lock/resetting of multi-point sensors are distracting to workflow and prone to error. Making a **True Focus** setting at (A) will ensure that focus is automatically adjusted in accordance with the change of camera angle.

True Focus uses yaw rate technology and by way of the **Absolute Position Lock** (APL) processor, logs camera movement as the basis for an extremely rapid compensatory focus reset without any shutter lag. The H6X's firmware then further perfects the focus using the precise data retrieval system found on all HC/HCD lenses.

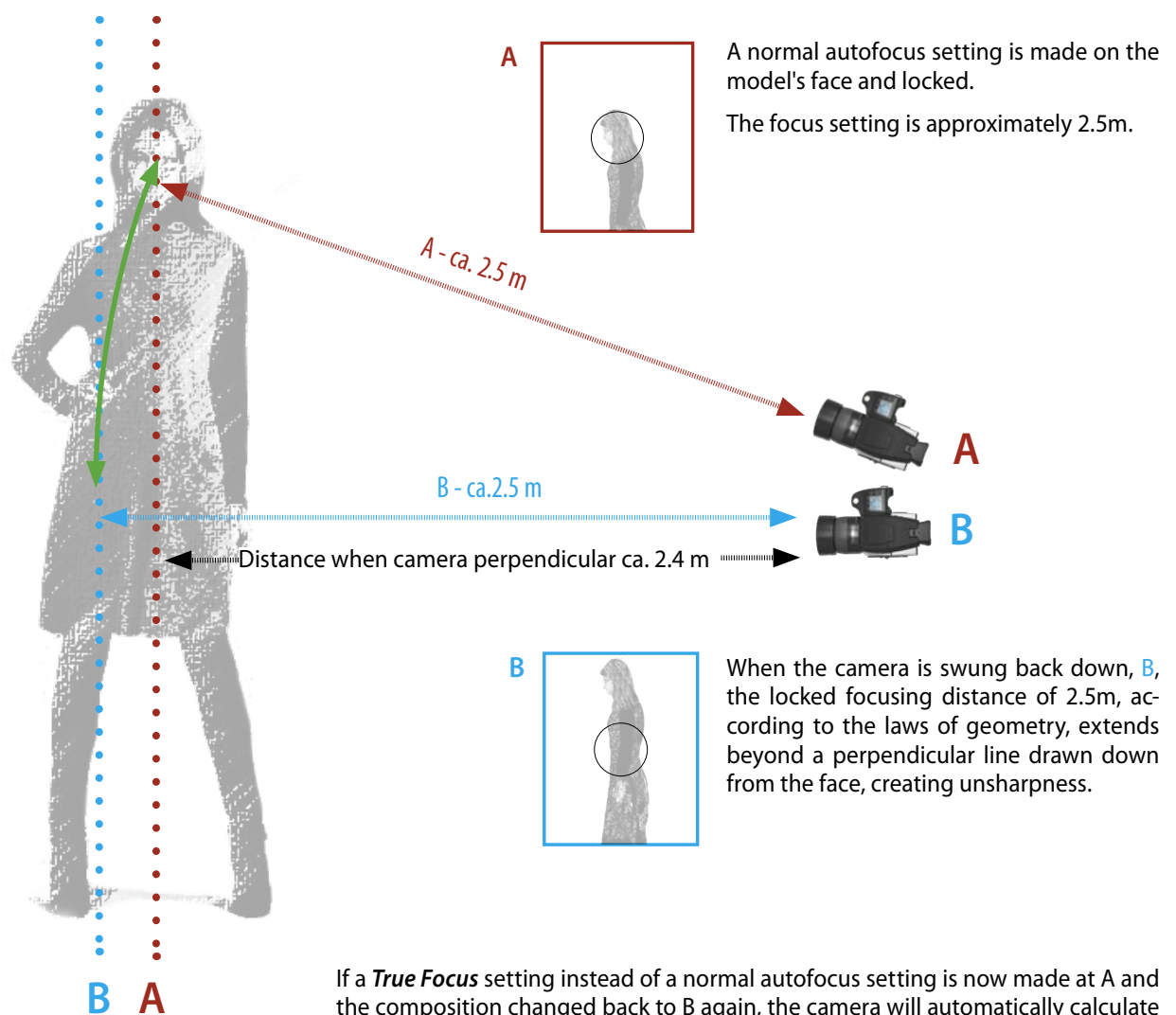

TRUE FOCUS AND CAMERA HANDLING

To obtain the maximum benefit from True Focus you should try to work within the requirements of the system. This might need a little practice but it will improve the accuracy of the measurements and thereby provide better results.

Firstly, try to remain as still as possible when making the first True Focus measurement and wait for the audio signal or ready light to show green again before continuing. This will not only speed up the process but also increase accuracy.

Secondly, when recomposing the shot you should try to stay in the same position as closely as possible. That is, try to avoid moving your head or body forwards or backwards as this will move the camera away from the measured position.

In the upper example to the right, the photographer has swung the camera from the first measurement to recompose the shot as normal. But you can see that the camera has now moved away from the original position.

The lower example illustrates essentially the same situation except this time the camera is more or less rotated around its central axis, rather than swung. The difference might seem slight but practice has shown that this method does retain the original position more accurately and therefore results in better focusing accuracy.



Incorrect 'swinging' of camera away from original position.



Correct 'rotation' of camera.

FOCUS CHECKING IN BROWSE, PREVIEW OR TRUE FOCUS MODE

A very effective way of checking the focus of individual captures is to assign the P1 or P2 (or Mirror Up or Stop Down) button to Focus Confirm.

In browse mode or after capture, press the P button. A cursor appears on the display which can be navigated via the scroll wheels or Navigation button to pinpoint the required area. Another press of the P button will zoom onto that particular part of the image for focus confirmation. The control wheels (or the Navigator) can now be used if areas close by are to be also checked. Otherwise, press it again to return to cursor view to be able to make a rapid new placement of the cursor for more checking.

In True Focus mode, instead of being located in the centre of the display, the cursor is automatically located near the original area chosen by you for the True Focus setting. This method provides a very convenient and rapid method for checking when using True Focus.

While browsing, press the assigned P button to activate the cursor which appears in the middle of the frame. Use the front and rear scroll wheels to move the cursor to the eye, for example. Press the P button again to produce a zoomed in close-up of the chosen area for focus checking.

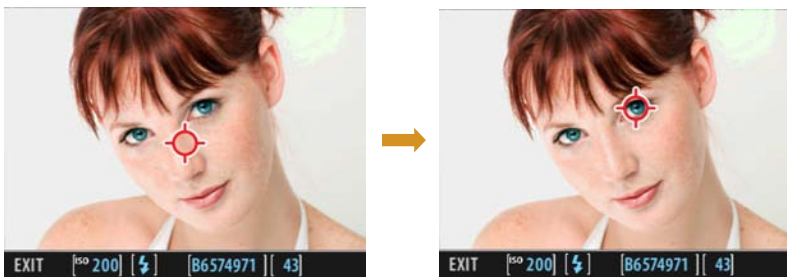

In True Focus, make a True Focus setting focused on the model's ear, for example. After recomposition, press the assigned P button which automatically positions the cursor over the chosen area. One more press of the P button produces a zoomed in close-up of the chosen area for focus checking without the need for extra navigation.

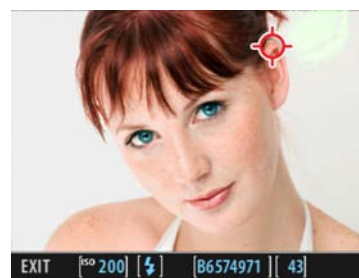

FOUR TRUE FOCUS METHODS

ACTIVATED BY SHUTTER RELEASE BUTTON – TRUE FOCUS RETAINED

MENU > SETTINGS > CUSTOM OPTIONS > # 31

In this mode the autofocus function is effectively converted into the True Focus function. That is, focus is set by half-pressing the shutter release button. Remember, though, that the True Focus function is retained until turned off in Custom Options.

1. Press **MENU** button on grip and select **Settings** or press **MENU** twice.
2. Select **Custom Options** and select #31 (True Focus in AF-S) with the **Front scroll wheel**. Select **ON** with the **Rear scroll wheel**. **Save**.
3. Aim camera at important area in subject and **half-press** the shutter release button.
4. Wait for the **True Focus** icon to appear (in the viewfinder) and the audio confirmation signal.
5. Maintain the half-press and recompose the picture. Press fully to capture. The True Focus icon disappears from the viewfinder. True Focus function is retained.

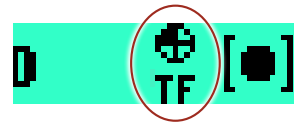

TEMPORARILY ACTIVATED BY A SELECTED CUSTOMIZABLE BUTTON – AUTOFOCUS RETAINED

MENU > SETTINGS > CUSTOM OPTIONS

In this mode the True Focus function is activated by pressing an assigned button. This produces a 'one-shot' setting where the camera reverts to its original Autofocus setting after capture. Useful if you want to quickly switch back and forth between True Focus and normal Autofocus. Works with or without a Custom Options #31 setting.

1. Press **MENU** button on grip and select **Settings** or press **MENU** twice.
2. Select **Custom Options** and the desired button to reassign with the **Front scroll wheel** (M.UP button in this example). Select **True Focus** with the **Rear scroll wheel**. **Save**.
2. Aim camera at important area in subject and press the selected button (the grip display now indicates **AF-T** mode).
3. Wait for the **True Focus** icon to appear (in the viewfinder) and the audio confirmation signal.
4. Recompose the picture and press shutter release button (camera does not re-focus because it is temporarily in **AF-T** mode). The True Focus icon disappears from the viewfinder. Camera reverts to **AF-S**.

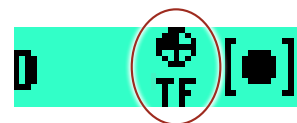

FOUR TRUE FOCUS METHODS – CONT

ACTIVATED BY TRUE FOCUS BUTTON – AUTOFOCUS DEACTIVATED

In this mode the True Focus function is activated by pressing the True Focus button. Normal autofocus is de-activated, therefore, pressing the shutter release button will not reset the focus. Useful when many shots are required with the same focus setting.

1. Press **AF** button. Select **True Focus** with the **Front scroll wheel**. **Save**.
2. Aim camera at important area in subject and press **True Focus** button.
3. Wait for the **True Focus** icon to appear (in the viewfinder) and the audio confirmation signal. Recompose the picture and press shutter release button.



Note that the True Focus adjustment is applied to all following captures until True Focus button is pressed again (when a new adjustment is made).

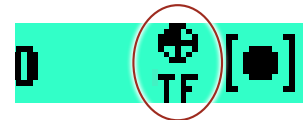

ACTIVATED BY AN ASSIGNED BUTTON – MANUAL FOCUS RETAINED

In this mode the True Focus function is activated by pressing an assigned button. This produces a 'one-shot' setting where the camera reverts to its original Manual focus setting after capture. Pressing the shutter release button will not reset the focus. Useful when many shots are required with the same focus setting.

1. Press **MENU**, select **Custom Options**, select the desired button to reassign with the **Front scroll wheel** (**M.UP** button in this example). Select **True Focus** with the **Rear scroll wheel**. **Save**.
2. Aim camera at important area in subject and press the selected button.
3. Ensure that the True Focus icon appears in the viewfinder.
Recompose the picture and press shutter release button. The True Focus icon disappears from the viewfinder. Camera reverts to Manual focus setting.



Note that the True Focus adjustment is applied to all following captures until the True Focus button is pressed again (when a new adjustment is made).

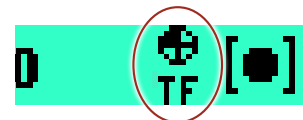

EXPOSURE CONTROL

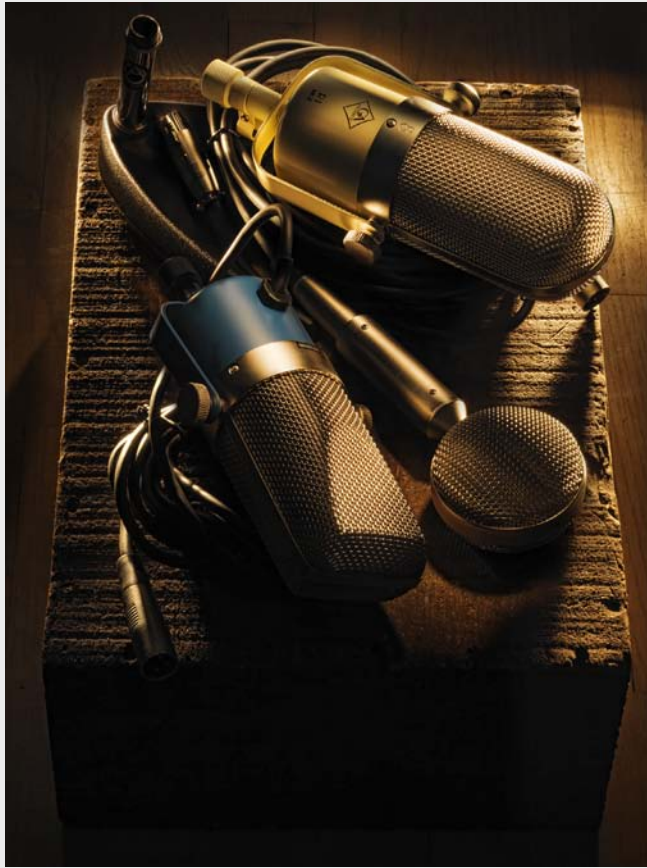

Photo: Joe Felzman © / Hasselblad Masters

■ ISO & WHITE BALANCE

– presets and manual

1. Press **ISO/WB**.
2. Turn the **FRONT scroll wheel** to select **ISO** setting.
3. Turn the **REAR scroll wheel** to select **WB (Daylight, Shade, Cloudy, Flash, Fluorescent and Tungsten)**.
4. To make a **Manual White Balance** setting (not a **White balance test exposure**), press the **Man. (AF)** button and then turn the **REAR scroll wheel** to choose a color temperature in figures (degrees Kelvin): **2000 – 10000 K**
5. Press **SAVE**.



■ ISO & WHITE BALANCE – WITH H5D /H6D SENSOR UNITS ONLY

Both ISO and White Balance can be set either via the grip, the sensor unit or, when tethered, via Phocus.

On the grip, the ISO/WB button provides immediate access to ISO and White Balance settings. The front and rear scroll wheels are used to make the desired changes. On the back, settings are changed with the zoom button. In Phocus there is a specific tool to control camera settings.

The settings are automatically and simultaneously transferred from the grip to the sensor unit. Likewise all changes on the sensor unit are automatically transferred to the grip display. Please note that the changes are only displayed on the sensor unit when the settings have been saved.

Note

H5D/H6D Sensor Units Only: White Balance settings are technically not necessary for 3F/3FR files because raw format files contain all the information required for correction in Phocus and/or other software, regardless of the original color temperature of the light source or color temperature setting of the camera at the time of exposure. However, if you intend to use Phocus / Phocus Quick for JPEG production, for example, and plan to deliver or print the JPEG files directly, then you should make a White Balance setting.

Tip

H5D/H6D Sensor Units Only: ISO and White Balance settings can be made either on the grip or the sensor unit. Settings are automatically updated on each other.

■ LIGHT METERING MODES

There are three reflective metering modes available. These have the following designations on the grip display:

- [●] – *Centre Weighted*
- [⊙] – *CentreSpot*
- [•] – *Spot*

Centre Weighted: Commonly used for ‘average’ light situations where there is no particular dominance of light or dark areas across the tonal range. Takes into account approximately 25% of the image seen in the viewfinder.

CentreSpot: Emphasizes the central section of the focusing screen equivalent to approximately 25% of the image.

This provides a balanced assessment and is a typical choice where the main subject is in the centre of the image.

Spot: The sensitive area is equivalent to approximately 2.5% of the image area (the central spot on the viewfinder screen). Any parts of the image outside of this area will not affect the exposure reading. This provides a very accurate measurement of specific tones. Typically used in the zone system and similar light measuring situations where maximum control is required. Also excellent for tonal comparison measurements. The spot mode can display ‘zones’ instead of EVs in the viewfinder display (see **Custom Options #14**).

■ EXPOSURE SETTING MODES

Exposure can be controlled either manually or by using one of four automatic modes. These have the following designations on the grip display:

- M** – Manual
- A** – Aperture (priority)
- S** – Shutter (priority)
- P** – Program
- Pv** – Program variable

In each mode you can see both the aperture and the shutter speed information on the grip display, viewfinder display and if set, the sensor unit display.

In manual mode, aperture is set by the front scroll wheel and the shutter speed by the rear scroll wheel unless set otherwise in **Custom Options #26**.

In the automatic modes, the aperture and shutter speed settings are controlled by the camera, either partially or completely according to setting. Within this mode there are four choices.

(Please see the **Appendix** for **P** and **Pv mode** charts that describe the aperture and shutter speed setting combinations.

■ SELECTING METERING / EXPOSURE SETTING MODES

Proceed as follows with the camera in active mode:

1. Press the **EXP** button on the viewfinder.
2. Turn the **Front scroll wheel** to make a **Metering method** selection and the **Rear scroll wheel** to make an **Exposure method** selection.
3. Press **Save** to retain the setting.

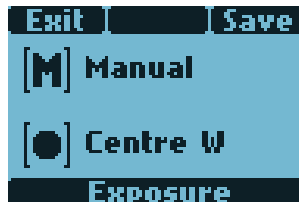

■ MANUAL EXPOSURE – M

Manual mode will provide total user scroll of the shutter and aperture settings. In this mode the shutter speed and aperture settings are manually chosen by turning the front and rear scroll wheels.

The standard exposure setting is obtained when the pointer over the exposure scale is positioned above the central index (in the viewfinder display).

Any deviation from this standard setting is displayed by:

- **the pointer appearing elsewhere than above the central index**

and

- **by figures above the scale representing the amount of adjustment in EVs.**

A '+ 0.7' above the scale in the display, as in **illustration 4** for example, would indicate a '0.7 EV overexposure' setting. Conversely, a '-2', for example, would indicate a '2EV underexposure' setting. Note that the appearance of a

+/- symbol on the grip and viewfinder displays in manual mode means that a change has been made to the exposure compensation setting. See later section on **Exposure compensation**.

The actual aperture settings and shutter speeds are indicated to the right of the exposure scale in the conventional manner. (Note: 'full-stops', 'half-stops' and 'third-stops' are also displayed, according to setting (see 'increment setting'). For example, a setting between f/8 and f/11 will appear as f/9,5 if 'half-stop' is chosen).

Tip

Access to the **B** and **T** shutter speed settings can be temporarily hidden. See **Custom Options #34**.

■ AUTOMATIC EXPOSURE – A, S, P, PV

Automatic exposure provides a choice of two ways of controlling shutter speed and aperture settings semi-automatically and two ways fully automatically:

Aperture priority: A - The aperture is manually chosen by you by turning the front scroll wheel, and the shutter speed is automatically chosen by the camera.

Shutter priority: S - The shutter speed is manually chosen by you by turning the front scroll wheel, and the aperture is automatically chosen by the camera.

Programmed: P - In this mode, an aperture / shutter combination is chosen by the camera according to the EV measured (metering method remains as your choice), though only within pre-set appropriate limitations to suit various requirements and applications.

Programmed variable: Pv - This mode is very similar to Programmed, except with the additional parameters of lens focal length being automatically taken into account. For example, long shutter speeds will automatically be avoided with a long focal length lens.

In **Automatic** mode the front scroll wheel selects alternative aperture /shutter combinations while maintaining the same EV and the rear scroll wheel alters the amount of exposure compensation. The compensation appears as a +/- symbol on the grip display and viewfinder display (illus. 4).

Variations (chosen by using the front scroll wheel) from the specific combination selected by the **P** or **Pv mode** are signified by a double arrow symbol appearing between the aperture and speed settings (illus. 5) on the grip display. These new variations provide the correct exposure but in different combinations.

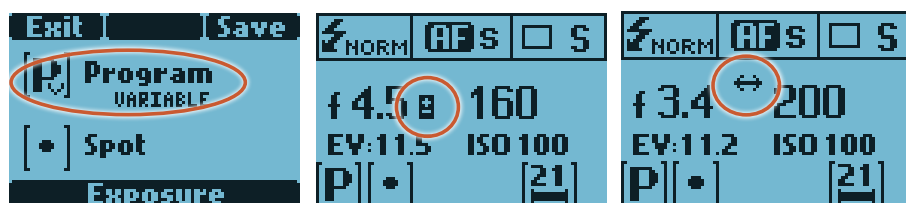

Tip

Aperture and shutter speed settings can both be changed even while the busy light on sensor unit is flashing.

■ AE-L BUTTON

This button has two main functions that can be incorporated in various working methods involving exposure locking. It also has an extra function for the flash measure capability (see **AE-L** section under **Flash**). The **AE-L** button can:

- lock an EV setting in manual and automatic modes.
- be used as a Zone System placement button.

a) When the button is pressed, the light metering facility is locked to the EV setting at that moment. An **L** (= locked) symbol appears between the shutter speed and the aperture indication on the grip display and viewfinder display to confirm the status. Press the **AE-L** button again to unlock (toggle function).

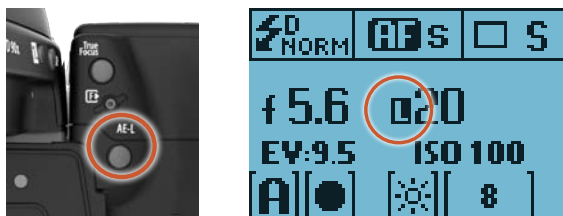

In the locked setting, the aperture and shutter speed become interlocked. In this way, a new aperture/shutter combination that still represents the same EV, can be rapidly chosen. For example, if you set the shutter at 1/125s and the aperture at f/8 and lock them together, you can access new EV-equivalent combinations of, for example, 1/30s at f/16 or 1/500s at f/4 just by moving the front scroll wheel.

In practice this means you could, for example, in auto mode, position the metering area (spot setting) over an area in the

subject that you determine to be equivalent to a mid-grey and lock it with the **AE-L** button. You can then recompose the picture with the metering zone positioned over an area much brighter or darker while still retaining the original exposure setting and choose a new combination of aperture and shutter speed settings.

b) The **AE-L** button also allows the spot metering function to make zone placements. When the **AE-L** button is pressed, the metered area is saved as a mid-grey (Zone 5). When the spot area is then placed over another part of the scene, the new area is then compared to the saved area and the difference can be read off the scale seen in the viewfinder. For example, in a landscape situation you could meter the foreground, lock the reading with the **AE-L** button (thereby locking that area to be reproduced as the equivalent to a mid-grey 18%), point the camera at some rocks to see by how much darker they are compared to the foreground by the EV difference read off the scale (illus 3).

If you have chosen **Spot** together with **Zone** display (see **Custom options #14** for settings) as well as one of the automatic modes **A, S, P** or **Pv**, point the spot marking at an area that you decide should be a Zone 5 and click the **AE-L** button (illus 4). The meter will now display different parts of the subject as zone values (illus 5) in the viewfinder display, instead of EV deviations, as you move the spot marking over the subject. (Included are Lo and Hi (illus 6) to signify areas beyond the range of the sensor).

Alternatively you can choose to re-classify an area as another zone and then check the rest of the subject to see how other areas fall on the zone scale. Do this by following the

above procedure and then turning the rear scroll wheel until you see the new desired zone value in the viewfinder display. You will also see the new exposure that will now produce that new zone. For example, you might have measured a rock at zone 5 but wish to make it darker. By moving the rear scroll wheel you could re-classify it as zone 4. You will then be able to see, for example, whether white clouds are now falling within the exposure range by their new zone classification.

Alternatively, you can also pre-set the initial zone reading in order to save time and effort where there is no freely available 'zone 5' subject for light measuring. For example, you might be on a sandy beach where you know that sand is normally classified as zone 6. You can pre-programme the zone placement by holding down the **AE-L** button while choosing the new zone value and turning the front scroll wheel until zone 6 appears. All new placements will then be zone 6.



New metered area is 1.8 EV lower than the area metered when the AE-L button was pressed.



AE-L button pressed to call the metered area 'Zone 5'.



Metered area reads 'Zone 8'.



Metered area above 'Zone 10'.

■ EXPOSURE COMPENSATION / QUICK ADJUST

The exposure compensation function, for both manual and automatic modes can be set from -5 to +5 EV, in 1/3, 1 or 1/2 EV increments (Custom Option #3) and is visible above the scale in the viewfinder and as a ± symbol on the grip display.



The quickest way to make an adjustment in auto-exposure mode is use the rear scroll wheel.

Temporary compensation setting in an auto-exposure mode using the Quick Adjust function:

- 1) Select chosen auto exposure mode.
- 2) Turn the rear scroll wheel to select the chosen amount of compensation.

The amount is displayed in the viewfinder as both an EV figure complete with a 'minus' or 'plus' prefix and as a marker above a 'minus' to 'plus' scale.

Default settings provide 1/3 EV compensation and an immediate clearing of the setting after capture.

However, in **Custom Options #3** you can select 1/3, 1 or 1/2 EV increment changes, in **Custom Options #23** you can choose to retain the setting after capture and in **Custom Options #17** you can deactivate the function.



Custom Options #3, #17 and #23 used to deactivate and alter the settings for the rear scroll wheel/Quick Adjust function.

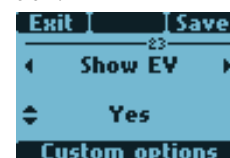

■ FIXED EXPOSURE COMPENSATION SETTING

- 1) Press the '±' button on the viewfinder.
- 2) Turn either the **Front scroll wheel** or **Rear scroll wheel** on the grip to increase or decrease the amount of compensation in 1/3 EV steps.
- 3) The amount is displayed in the viewfinder as both an EV figure complete with a 'minus' or 'plus' prefix (A in illustration), and as a marker above a 'minus' to 'plus' scale (B in illustration).
- 4) Press **Clr** (AF button) to reset any compensation back to zero.
- 5) Press **Save** (ISO / WB button) to retain the setting.
- 6) A '±' symbol is then displayed between the aperture and shutter speed setting as confirmation of the setting.



MENU



Photo: Tom D. Jones © / Hasselblad Masters

OVERVIEW OF NAVIGATING MENU AND SETTINGS

Navigating the menu and accessing the settings on the grip is achieved by pressing the buttons surrounding the display and turning the scroll wheels. Note that some of the buttons are modal and so have several functions which is indicated by the designation that appears closest to that particular button when navigating. For example, the ISO/WB button also acts as a SAVE button.

Here is an example of the necessary steps to take to make a setting change, in this case Bracketing. The actions are illustrated in full here to clearly describe the procedure. The procedures later on in this manual are described and illustrated in an abbreviated manner so it wise to study this full description first.

1



Press the **MENU** button to access the menu from the regular info display.

2



Turn the **Front Scroll Wheel** until **Settings** appears.

3





Press **Enter (ISO/WB button)**.

4





Turn the front scroll wheel to access the options.

-  **Number of Captures** (the number of captures required in the sequence)
-  **Sequence** (the sequential order of the over- or underexposures)
-  **Step** (the amount of EV variation from the standard exposure setting)

5



In  turn the rear wheel to choose the number of frames required: **2, 3, 5, 7 or 9**.

In  turn the rear wheel to choose one of the four sequences.

In  turn the rear wheel to choose the amount of EV variation required: **3, 2, 1, 1/2, 1/3 EV**.

6



Press **Save (ISO/WB button)** or make a 'quick save' by half-pressing the shutter release button. To escape press **ESC (Profiles button)**. When finished, press **Exit (FLASH button)**.

The following is a list of the various terms describing the various actions that appear on the grip display:

- Enter:** navigates down one level on the menu.
- Exit:** navigates back up one level on the menu. Does not save any settings.
- Off:** deactivates the particular function being set.
- On:** activates the particular function being set.
- Sel.:** (Select) - selects the character marked for image info and profile name
- ESC:** (Escape) - terminates an action and returns to the main screen. Does not save any settings.
- Save:** saves a setting and also moves screen back up one level on the menu. Can save many changes made in a setting sequence.

SAVE ACTIONS

Remember the following groupings of 'saved' and 'not-saved' actions when making settings changes.

SAVED

'Quick save' - half-press shutter release button

Save - press save button (ISO/WB button)



NOT SAVED

Escape - press ESC button (PROFILES /ESC button)

Exit - press exit button (FLASH button)



GENERAL OVERVIEW OF MENU



Self timer options

- Exit On Save: Self Timer Off (10s)
- Exit On Save: Self Timer Off (MIRROR GOES DOWN)
- Exit On Save: Self Timer Off (DELAY/MIRROR UP)

Bracketing options

- Exit On Save: Bracketing Off (3 frames)
- Exit On Save: Bracketing Off (1/3 EV)

Interval options

- Exit On Save: Interval Off (2 frames)
- Exit On Save: Interval Off (0 m 5 s)

Settings options

- Exit Enter: Custom options
- Exit Enter: Image info
- Exit Enter: Date & time
- Exit Enter: System status

Text setting

- Exit Sel Save: Jens Karlsson

Custom Options

Exit Save: Display off time (Set in SU)	Exit Save: Ev increment (1/2 Step)	Exit Save: Exp. adjust increment (1/3 Step)	Exit Save: True Focus (True Focus)	Exit Save: AE-L button function (AE-Lock)
Exit Save: Stop down button function (Stop down)	Exit Save: MUP button function (Mirror up)	Exit Save: Control wheel direction (Clockwise)	Exit Save: Flash ready exposure lock (Yes)	Exit Save: Magazine exposure lock (Yes)
Exit Save: Lens exposure lock (Yes)	Exit Save: Out of range exposure lock (No)	Exit Save: True exposure (On)	Exit Save: Spot mode (Normal)	Exit Save: Focus aid in MF (Half press)
Exit Save: AF assist light (Camera)	Exit Save: Rear wheel quick adjust (Yes)	Exit Save: Control lock (All controls)	Exit Save: Film wind-on (Half press)	Exit Save: Beeper (On)
Exit Save: Show histogram (Yes)	Exit Save: Interval & Self timer (Exit)	Exit Save: AE-lock / Quick adjust (Exp reset)	Exit Save: Show EV (Yes)	Exit Save: Show ISO (Yes)
Exit Save: Bracket param. in Manual (Shutter speed)	Exit Save: Aperture ctrl. in Manual (Front wheel)	Exit Save: Low flash warning (On)	Exit Save: Interval timer initial delay (None)	Exit Save: Aperture indication (Normal)
Exit Save: Extra mirror delay (50 ms)	Exit Save: True Focus in AF-S (Off)	Exit Save: Always return to mirror (No)	Exit Save: AE-lock at halfpress (Off)	Exit Save: Hide B/T-mode (Off)

System status

- Exit Next: Body 772 (Mag: VF: 59 Lens: 1495) Info - Usage
- Exit Next: Body 910 (Mag: VF: 65.0 Lens: 138.0) Info - Version
- Exit Next: Focus calib. ID 1 / 131844 Info - Calib

Drive

- Exit Save: Single (S)
- Exit Save: Continuous (C)

These arrows signify the **FRONT** scroll wheel is used to select these options.

These arrows signify the **REAR** scroll wheel is used to make settings changes.

Note

At very low temperatures the displays might require a few seconds to present new settings.

■ SETTINGS

Apart from the more regularly used ISO/WB, AF, Flash buttons and features accessible on the grip there are a number of other features available. These provide the integral fitnesses that make the H6X a powerful and sophisticated tool to satisfy a variety of professional demands.

There are five functions: **Self timer, Bracketing, Interval, Settings and Drive.**

Regular use can be simplified by using the shortcuts and button reassignment to access the menus.

One point to remember when making settings is that certain options are only available when the relevant screen has been accessed. For example, in Self Timer the choice of 'delay/mirror up' or 'mirror up/ delay' is only available (by turning the rear scrollwheel - lower row on display) when the relevant function has been chosen (by turning the front scroll wheel - upper row on display)

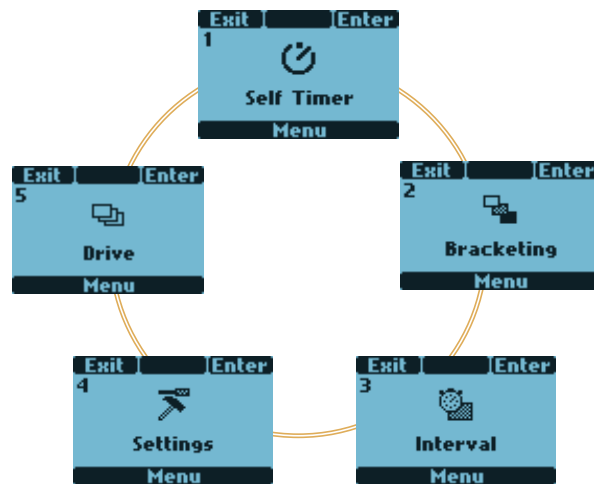

■ SELF TIMER

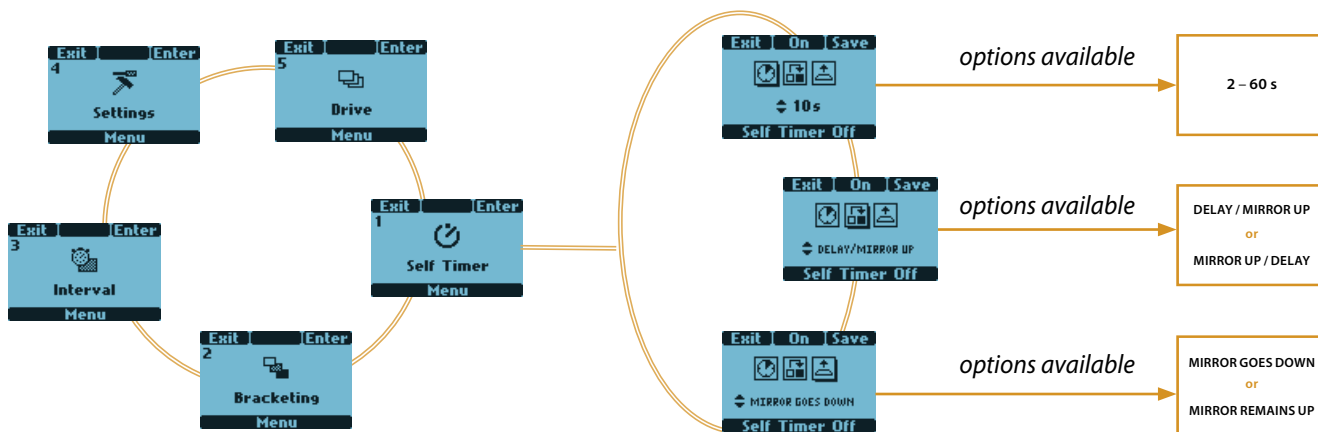



The self timer allows a delay in the activation of the shutter and a change in sequence of the mirror movement. Normally the mirror is raised before the shutter is tripped creating a pause between the two actions to minimize camera vibration. However, during this pause there will be no image in the viewfinder and no light metering available for any eventual exposure change. Therefore the Self timer function can be set to a sequence where the delay is followed by the mirror being raised instead. Normally the mirror will instantly return after a capture but you can also choose a setting where the mirror remains raised.

As it provides a timed, remote shutter release function it can be used instead of a remote release cable/cord/device when split-second timing is not critical. The camera's exposure settings (Manual or Auto) will be according to the light metering requirements just prior to the mirror being raised so, in very changeable lighting conditions, choose the mode most suitable if using long delays.



continued over →

SELF TIMER SETTING – continued

- 1) Press **MENU** on grip.
- 2) Turn **Front** scroll wheel until **Self Timer** appears.
- 3) Press **ENTER**.
- 4) Turn **Front** scroll wheel to access the options, that are:

-  **Delay**
-  **Mirror sequence**
-  **Mirror Up / Mirror Goes Down**

(A drop shadow will be displayed beneath the selected symbol, for example )

- 5) When **Delay** is highlighted –  – turn the **Rear** scroll wheel to choose a delay range from 2 - 60s in 1s intervals.
- 6) Turn the **Front** scroll wheel again to choose **Delay / Mirror Up, Mirror Up/ Delay** sequence – . When highlighted turn the **Rear** scroll wheel to choose.
 - Delay / Mirror Up** sequence =
Delay for set amount of time – mirror raised – capture made.
 - Mirror Up/ Delay** sequence =
Mirror raised – delay for set amount of time – capture made.
- 7) Turn the **Front** scroll wheel again for **Mirror goes down / Mirror remains up** –  – choice. Turn the **Rear** scroll wheel to choose.

- Mirror goes down =**
Mirror returns to its normal position and the camera is made ready for the next capture.
- Mirror raised =**
Mirror remains in raised position. No image is visible in the viewfinder until M UP button pressed.

- 8) Press **On**. Note that this now reads **Off** and the line of text at the bottom of the screen reads **'Self timer on'**.
- 9) Press **SAVE**.
- 10) Press **ENTER** again from the Self Timer screen to activate the function.
- 11) Press **On**.
- 12) Half-press the shutter release button to standby mode for this function (press the shutter release button again (full press) for activation) or full-press the shutter release for immediate activation.

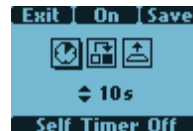

'Delay' highlighted with drop shadow. 10 seconds chosen.



Mirror sequence highlighted. 'Delay first, then mirror raised' chosen as option.



Mirror down /up highlighted. 'Mirror down after capture' chosen as option.



Tip
Check the lower text-row on the screen for ON or OFF status.

Note
You can halt the sequence by clicking the ON / OFF (ESC) button.

Tip
Press the Mirror Up button twice within 0.5s to access the self timer mode directly.

BRACKETING

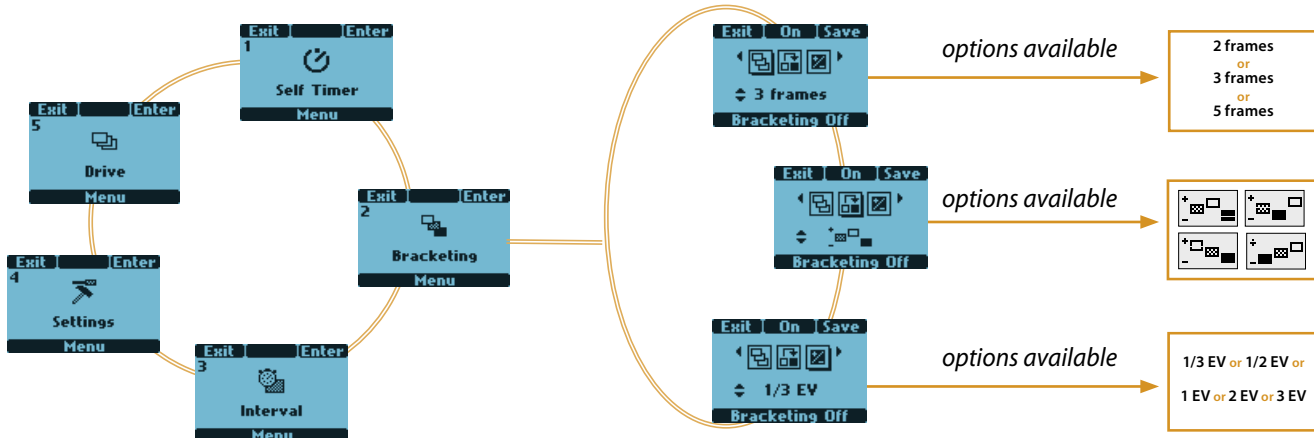

The bracketing function provides an automatic series of captures; one at the standard exposure setting (Manual or Auto) and the others with pre-determined deviations in EV from the standard exposure. This is particularly useful for images containing a very wide tonal range, for example.

Firstly you make an assessment concerning the number of extra frames required, the order in which they should be taken, and by how much the EV deviation there should be and the setting made accordingly. The first metered exposure (Manual or Auto) is the EV that determines the calculations for the bracketing sequence.

Note the difference in operation between **Single** and **Continuous** drive settings:

- At the **Single** setting you must press the shutter release button separately for every separate capture until the sequence is finished.
- At the **Continuous** setting you can either maintain the pressure on the button to take all frames without stopping or you can release the pressure on the button and press again to continue to the end of the sequence without losing any frames within the set sequence.

BRACKETING SETTING

- 1) Press **MENU** on grip.
- 2) Turn the **Front** scroll wheel until **Bracketing** appears
- 3) Press **ENTER**.
- 4) Turn the **Front** scroll wheel to access the options, that are:

- Number of Captures** (the number of captures required in the sequence)
- Sequence** (the sequential order of the over- or underexposures)
- Step** (the amount of EV variation from the standard exposure setting)

(A drop shadow will be displayed beneath the selected symbol, for example)

- 5) In turn the **Rear** scroll wheel to choose the number of frames required: **2, 3, 5, 7 or 9.**
- 6) In turn the **Rear** scroll wheel to choose one of four sequences:
 - A: **Standard, Over, Under**
 - B: **Standard, Under, Over**
 - C: **Over, Standard, Under**
 - D: **Under, Standard, Over**

– continued

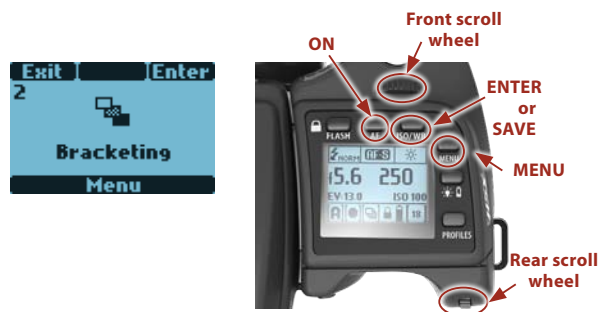

Number of captures highlighted. 3 captures chosen as option.

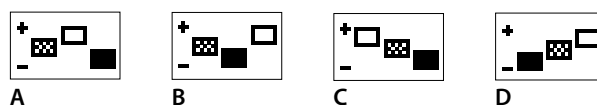

continued over →

7) In  turn the **Rear** scroll wheel to choose the amount of EV variation required: **3, 2, 1, 1/2, 1/3 EV**.

8) Press **SAVE**.

9) Press **ENTER** again from the Bracketing screen to activate the function. Press **On**. Note that this now reads **Off** and the line of text at the bottom of the screen reads '**Bracketing on**'.

Half-press the shutter release button to standby mode for this function (press the shutter release button again (full press) for activation) or full-press the shutter release for immediate activation.

To escape from this mode press **MENU**, then **Enter** on the Bracketing screen, then **Off** (AF button).



Sequence highlighted. 'Standard, over, under' chosen as option.

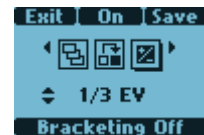

Step highlighted. 1/3 EV variation chosen as option.

EXAMPLE

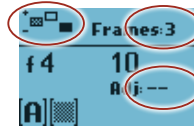

Screen after Bracketing setting activated indicating 3 frames remaining in a Standard, Over, Under, sequence with no adjustment to the next frame.

EXAMPLE



Viewfinder display indicating no adjustment to next frame and three frames left in the sequence.

Tip

A bracketing sequence can be stopped mid-sequence by pressing the ESC (ON.OFF) button.

Note

As an example, a 5 frame sequence with an EV 1 variation setting at 'Standard, Over, Under' would produce: Standard (0 EV variation), +1EV, -1EV, +2EV, -2EV.

Tip

Check the lower text-row on the screen for ON or OFF status.

Note

The default setting is a shutter speed change in a bracketing sequence. However, if the camera is set in Manual mode, you can choose an aperture change instead (Custom Options > Bracket param. in Manual #25 on grip).

Note

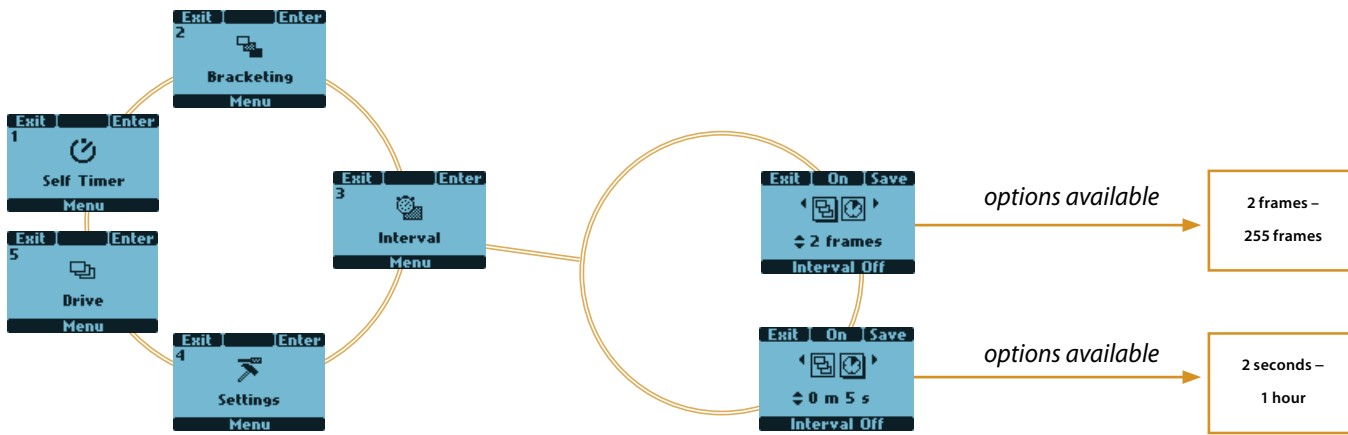

See note at the beginning of this section regarding the difference between Single and Continuous drive settings. In both cases, the bracketing function is automatically reset for a new sequence.

INTERVAL



By using the interval setting, you can allow the camera to take a series of captures automatically over a set period. This is often required for time and motion studies, security surveillance, nature study, etc. The exposure and focus settings (Manual or Auto) will be according to the camera settings at the time of capture.

INTERVAL SETTING

- 1) Press **MENU** on grip.
- 2) Turn the **Front** scroll wheel until **Interval** appears.
- 3) Press **ENTER**.
- 4) Turn the **Front** scroll wheel to access the options, that are:
 -  **Number of captures** (the number of captures required)
 -  **Interval duration** (the time interval between each capture)

(The selected feature symbol is indicated by a drop shadow)
- 5) In Number of captures, turn the **Rear** scroll wheel to choose the number of captures required: **2 – no limit**
- 6) In Interval duration, turn the **Rear scroll wheel** to choose:
 - 2 seconds – 1 hour**
- 7) Press **SAVE**.
- 8) Press **ENTER** again from the Interval screen to activate the function. Press **On**. Note that this now reads **Off** and the line of text at the bottom of the screen reads **'Interval on'**.

Half-press the shutter release button to standby mode for this function (press the shutter release button again (full press) for activation) or full-press the shutter release for immediate activation.

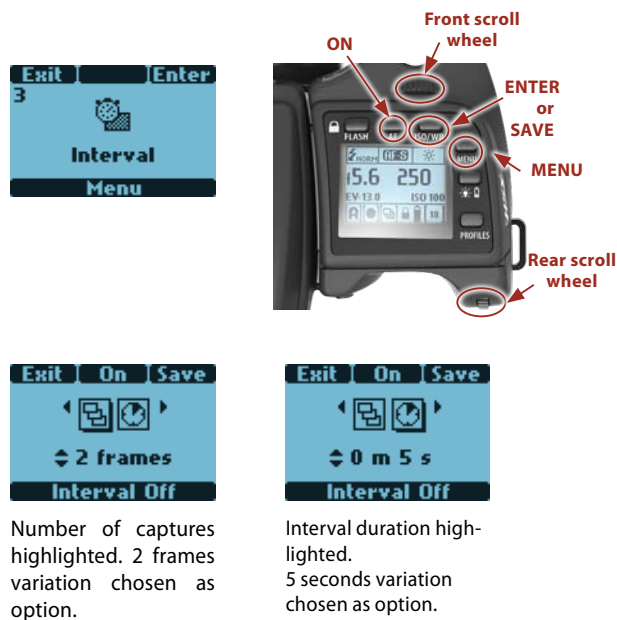

Screen after Interval setting activated indicating 3 shots remaining at 30 second intervals.

Tip
Check the lower text-row on the screen for ON or OFF status.

Note
In Custom Options #28 on grip you can select an initial delay of None, 2, 10, 60 seconds or the interval time.

Tip
An Interval setting can be stopped mid-sequence by pressing the ESC button.

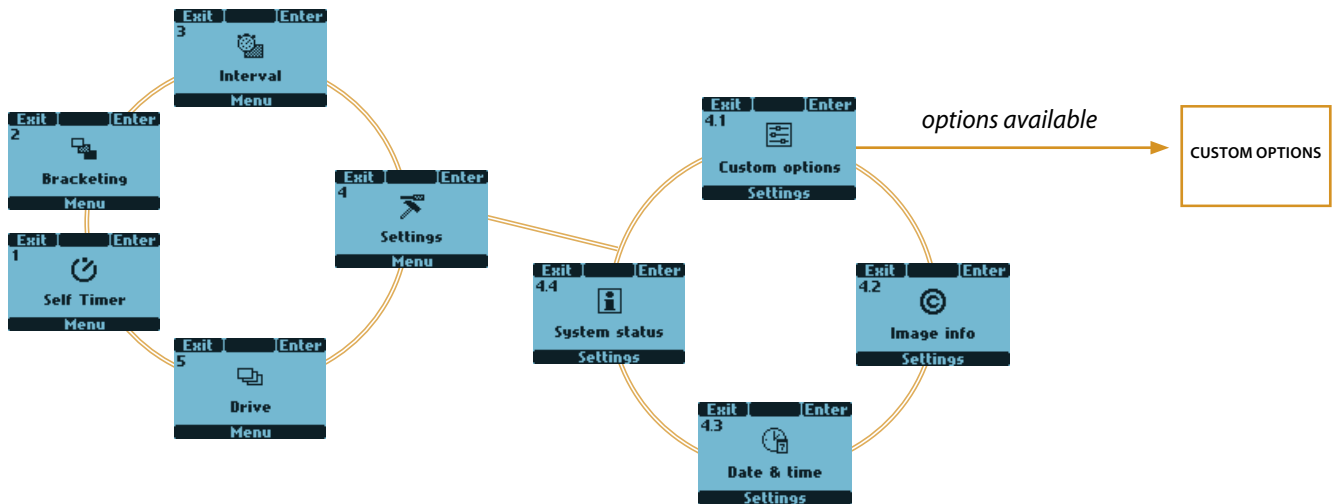

From the **Settings** screen you can access four main sub-settings: **Custom options**, **Image info**, **Date & Time** and **System status** by turning the front scroll wheel. From each of these

sub-settings you can access further items for setting changes. Look at the main menu chart to get an idea of where all the options are on the menu tree.

CUSTOM OPTIONS

- 1) Press **MENU** on grip.
- 2) Turn the **Front** scroll wheel until **Settings** appears.
- 3) Press **Enter**.
- 4) Turn the **Front** scroll wheel to access **4.1 Custom options**.
- 5) Press **Enter** to access the 34 choices available.
- 6) Turn the **Front** scroll wheel to the desired **option**.
- 7) Turn the **Rear** scroll wheel to the desired **setting**.
- 8) Press **SAVE**.

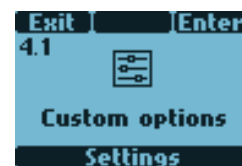

If you want to reset the camera to the default setting for all options, press the **ON.OFF** button quickly to enter **Profiles**, select **Standard** and then press **Load**.

Tip
As a shortcut to a specific customizable button (True Focus, AE-L, M.UP, Stop Down) setting in Custom Options, press MENU and then the desired button with camera in active mode. After making any changes, press the shutter release button to save the new setting.

Tip
As a shortcut to Custom Options level, press the MENU button twice with camera in active mode. The latest setting will automatically appear. After making any changes, press the shutter release button to save the new setting.

CUSTOM OPTIONS

The following is a description of all the Custom Options accessible through the grip display. They are accessed by **Menu** > **Settings** > **Custom Options**. The words and figures in red signify the default setting for that option.



Display off time 1

- 10s • 20s • 30s • 60s

Determines the amount of time elapsing before the display automatically turns off. Set on the sensor unit > **Menu** > **Settings** > **Custom Options** > **Display Off**.



EV increment 2

- 1/2 Step • 1 Step • 1/3 Step

Determines the amount of EV change applied (per click of either the front or rear scroll wheels) to either aperture or shutter speed.



Exp adjust increment 3

- 1/3 Step • 1 Step • 1/2 Step

Determines the amount of EV change applied (per click of the rear scroll wheels) when making fixed exposure adjustment settings.



True Focus button function 4

- True Focus

but can be reassigned to:

AF Drive • AE-lock • Self Timer • Bracketing • Mirror up • Stop Down • B mode • T mode • Flash Measure • Interval timer • Cycle LM mode • Expose • Display Off • Histogram • Delete • Grey bal ex • Spirit Level • Rear Info Screen • None

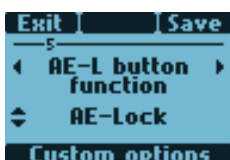

AE-Lock button function 5

- AE-lock

but can be reassigned to:

AF Drive • Self Timer • Bracketing • Mirror up • Stop Down • B mode • T mode • Flash Measure • Interval timer • Cycle LM mode • Expose • Display Off • Histogram • Delete • Grey bal ex • Spirit Level • Rear Info Screen • None



Stop down function 6

- Stop Down

but can be reassigned to:

AF Drive • AE-lock • Self Timer • Bracketing • Mirror up • B mode • T mode • Flash Measure • Interval timer • Cycle LM mode • Expose • Display Off • Histogram • Focus conf • Delete • Grey bal ex • Spirit Level • Rear Info Screen • None



M.UP button function 7

- Mirror up

but can be reassigned to:

AF Drive • AE-lock • Self Timer • Bracketing • Stop Down • B mode • T mode • Flash Measure • Interval timer • Cycle LM mode • Expose • Display Off • Histogram • Focus conf • Delete • Grey bal ex • Spirit Level • Rear Info Screen • None



Control wheel direction 8

- Clockwise • Counter clockwise

Determines the effect the direction of the controls wheels have on a setting.

For example, by moving the front scroll wheel to the left you can alter the aperture setting from f/8 to f/6.8 to f/5.6 and so on. By changing the wheel direction setting however, the same action of turning the wheel to the left would then produce the opposite effect, that is, the aperture settings would change from f/ 8 to f/ 9.5 to f/ 11, and so on.

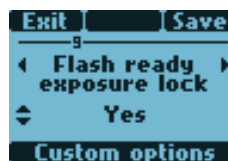

Flash ready exposure lock 9

- Yes • No

Allows you to make a capture before the flash is fully charged. For use with integral flash unit or other TTL compatible flash units connected to the hot-shoe. Not valid for flash units connected by the PC connector.

Yes blocks the shutter until flash is ready.

No allows shutter release before flash is ready.



Magazine exposure lock 10

- **Yes** • No

Allows you to release the lens and auxiliary shutter in camera body without a sensor unit attached.

Yes blocks the lens shutter and auxiliary shutter in camera body if the sensor unit is not attached. Generates message on grip display if attempted.

No allows the lens shutter and auxiliary shutter in camera body to be released without the sensor unit attached.

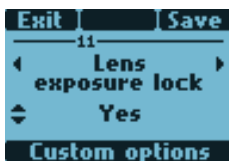

Lens exposure lock 11

- **Yes** • No

Allows you to release the auxiliary shutter in camera body without a lens attached.

Yes blocks the release of auxiliary shutter in camera body if there is no lens attached. Generates message on grip display if attempted.

No allows a release of auxiliary shutter in camera body without a lens attached.



Out of range exposure lock 12

- **No** • Yes

Allows you to release the camera when either the aperture or shutter speed setting is beyond the working range (indicated on the displays by “-”).

Yes blocks the shutter if beyond the working range.

No allows the shutter to be released (1/800s or 32s) if beyond the working range.

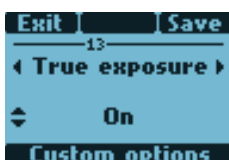

True exposure 13

- **On** • Off

Determines whether the exposure is automatically adjusted to create a true exposure setting. (See **Appendix** for full explanation).

On allows the adjustment.

Off retains the normal setting.

Note

If using flash/strobe as the main light source and 1/800s shutter speed, remember to turn off the True Exposure option.

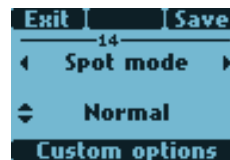

Spot mode 14

- **Normal** • Zone

Determines how the camera behaves when set to Spot Mode.

Normal makes the camera behave in the same fashion as when set to Average or Centre Weighted.

Zone makes the camera behave in the same fashion as the Hasselblad 205FCC. That is, the central spot is placed over a particular area of the subject and the AE-L button is pressed. The exposure is then calculated assuming that the metered area is 18% grey or Zone 5 and is indicated on the display as Zone 5. Alternatively, the area can be reassigned to another zone by turning the rear scroll wheel.

Then, when the camera is moved, the areas within the central spot are indicated by their zone values.

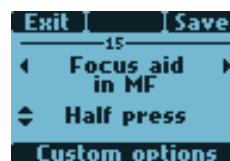

Focus aid in MF 15

- **Half press** • Always • Off

Sets how the focus aid arrowhead LED symbols appear in the viewfinder display in manual focus mode.

Half press makes them visible when the shutter release button is pressed half way.

Always makes them visible all of the time when camera is active.

Off disables them completely.



AF assist light 16

- **Ext flash** • Camera • Off

Allows projection of light pattern to assist the autofocus system in poor light or low contrast situations.

Camera sets the integral AF assist illumination to be always active.

External flash activates the AF assist illumination projected by a suitable attached external flash unit. When detached, however, the integral system is automatically used.

Off sets the AF assist illumination to remain always inactive.

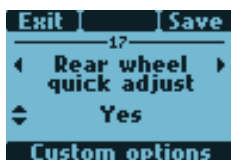

Rear wheel quick adjust 17

- **Yes** • No

Allows rear scroll wheel to make a rapid EV adjustment (or EV compensation) in auto-exposure mode.

Yes turns the setting on. By turning the rear scroll wheel, the adjustment is made and appears on both displays as a \pm symbol between the shutter speed and aperture values. The amount of deviation also appears above the scale to the left of the aperture value on the viewfinder display.

No turns the function off completely.



Control lock 18

- **All controls** • All but TrueFoc. • Wheels • Off

Sets the amount of locking used when the Control Lock (FLASH) button is pressed.

All controls locks scroll wheels and buttons.

All but TrueFoc. locks scroll wheels and buttons except True Focus.

Wheels locks only scroll wheels. They remain operable in any setting mode, however.

Off disables lock function.



Film wind-on 19

- Direct • **Half press**

Sets when the film will be advanced to the first frame.

Direct advances film automatically to the first frame when the film holder is inserted or when the magazine is attached.

Half press advances the film only when the shutter release is pressed to half press position.



Beeper 20

- On • **Off**

Sets the audible beeper signal.

On enables the signal.

Off disables the signal.

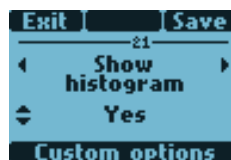

Show histogram 21

- **Yes** • No

Sets whether a histogram of a capture appears on the display after exposure.

Yes enables the setting.

No disables the setting.



Interval & Self Timer 22

- **Exit** • Stay

Allows either the Interval or Self Timer mode to remain active after a capture or immediately return to standard setting.

Exit clears the setting and produces an automatic return to standard setting after a capture.

Stay retains the setting after a capture.



AE lock / Quick adjust 23

- **Exp reset** • Saved

Allows either the AE-Lock or Quick adjust mode to remain active after a capture or immediately return to standard setting.

Exp Reset clears the settings and produces an automatic return to standard setting after a capture.

Saved retains the AE-Lock or Quick adjust settings after a capture.

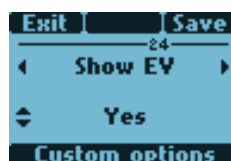

Show EV 24

- **Yes** • No

Allows the display of EV settings on the grip display.

Yes enables the display.

No disables the display.

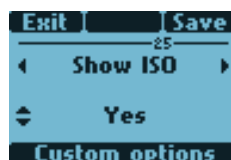

Show ISO 25

- **Yes** • No

Allows the display of ISO settings on the grip display

Yes enables the display.

No disables the display.



Bracket param. in Manual 26

- **Shutter speed** • Aperture

Selects either the shutter speed or the aperture as the parameter which changes in a bracketing sequence when in Manual exposure mode.

Shutter speed selects changes in shutter speed.

Aperture selects changes in aperture settings.



Aperture control in Manual 27

- **Front wheel** • Rear wheel

Selects which scroll wheel changes the aperture setting when in Manual exposure mode.

Front wheel selects the front scroll wheel to change the aperture setting.

Rear wheel selects the rear scroll wheel to change the aperture setting.



Low flash warning 28

- **On** • Off

Controls the display of the 'Low flash' warning message and triangle.

ON enables the function.

OFF disables the function.



Interval timer initial delay 29

- **None** • 2s • 10s • 60s • Interval time

Allows an initial delay before the first capture of an interval timer function operation.



Aperture indication 30

- **Normal** • Light meter

Allows choice of aperture indication display (in Manual mode only).

Normal selects conventional display (f5.6, f8, etc)

Light meter selects 'light meter' type display (f5.6⁰, f8.⁵, etc)



Extra mirror-delay 31

- 25 ms • **50 ms** • 100 ms • 200 ms • None

Extends the delay period between the mirror being raised and the opening of the lens shutter thereby reducing the negative effect of vibration on longer exposure times.



True Focus in AF-S 32

- **Off** • on

Re-assigns half press of shutter release button to activate True Focus function instead of standard automatic focus (single)



Always return mirror 33

- **No** • Yes

Automatically lowers mirror again for viewing at the end of every mirror-up sequence.



AE lock at half press 34

- **Off** • On

Allows access to AE-lock without having to use customizable button assigned to other required functions.

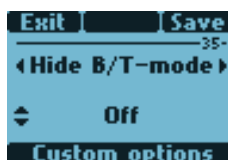

Hide B/T mode 35

- **Off** • On

Hides access to B and T shutter speeds allowing smoother transition from 1s to 1.4s when making shutter speed changes.

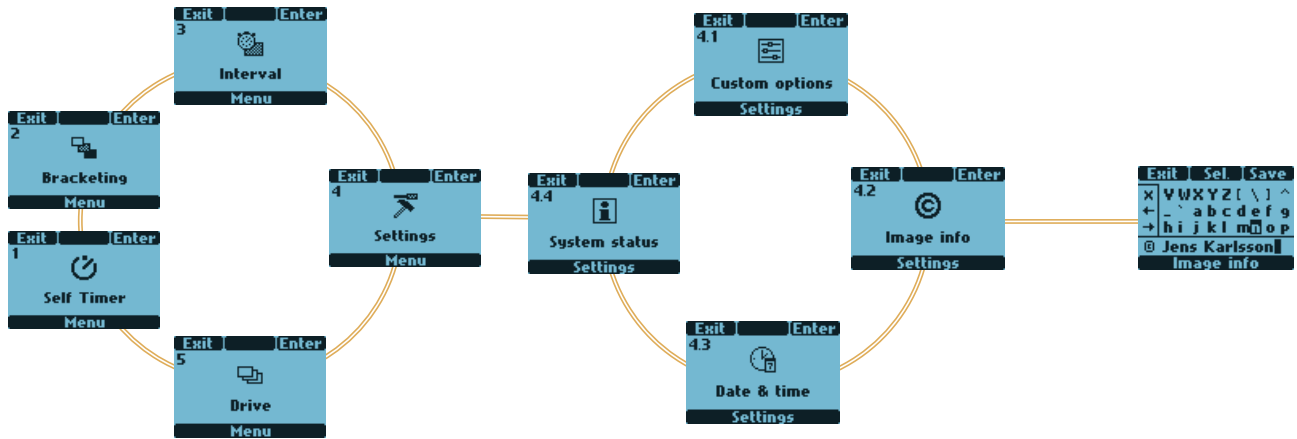

In Image info you can compose your own combination of letters, words, symbols, etc to be included in the metadata. The same procedure is also used to change a Profile name.

IMAGE INFO SETTING

- 1) Press **MENU**.
- 2) Turn the **Front** scroll wheel until **Settings** appears.
- 3) Press **ENTER**.
- 4) Turn the **Front** scroll wheel to access **4.2 Image info**.
- 5) Press **ENTER** to access the list of characters and figures available.
- 6) By turning the **Front** scroll wheel, the character selector cursor will move to the left and right in the available characters while the rear scroll wheel moves it up and down. The chart of characters will automatically scroll to reveal the whole set. The space character is top left in the list.



On the left side of the screen there is a small box frame containing two arrow symbols and an **X** symbol. By selecting the arrows you can position the cursor in the line of text you have created. The **X** symbol deletes the selected character.

To create a line of text, select the desired character and press then **Sel** (**AF** button). That character is then automatically added to the line of text below the character chart. Press **Save** (**ISO/WB** button) to store the new setting.

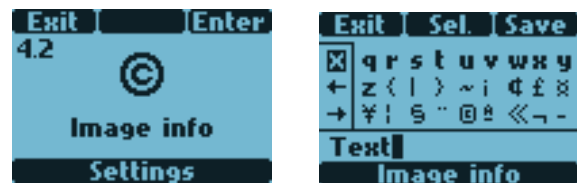
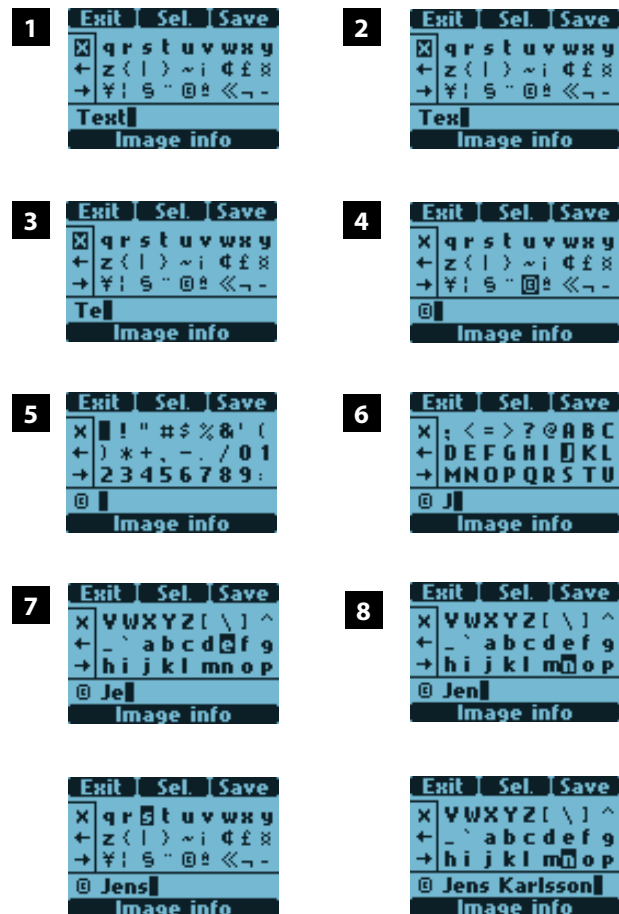

IMAGE INFO SETTING

Here is an example of how to change existing text (in this case the word 'Text' to a copyright symbol plus a photographer's name - 'Jens Karlsson'). See previous section 4.2 **Image info** for procedure description.

- 1) Start by accessing the **Image info** screen. On the text row towards the bottom of the screen, the text line cursor is automatically placed to the right of the character that is to be changed. Turn the front and rear scroll wheels to move the selector cursor until the X symbol is highlighted.
 - 2) Press **Sel.** (AF button) and the character will be erased.
 - 3) Repeated pressing of **Sel.** will progressively erase all the characters in the line.
 - 4) After erasing unwanted text, turn the front and rear scroll wheels until the desired character is highlighted by the selector cursor (in this case the copyright symbol) and press **Save**. Note that more symbols have automatically appeared as you scrolled down the screen.
 - 5) Choose the next character in the same manner (in this case a space) and press **Save**.
 - 6) The capital letter 'J' has been highlighted and saved in this example.
 - 7) Repeat the procedure until all the letters and characters you want appear. As you progress with more characters, those to the left will temporarily disappear from the screen so that you can see what you are adding. Don't forget there is a maximum of approximately 40 characters.
- If you make a mistake you must remove each character singly (see steps 1-3 above) until you reach where you want to make a change and then return to the 'Adding text' procedure again.
- 8) This example shows a completed 15 character text line with symbols, spaces, upper and lower case (large and small) letters.



SETTINGS > DATE & TIME

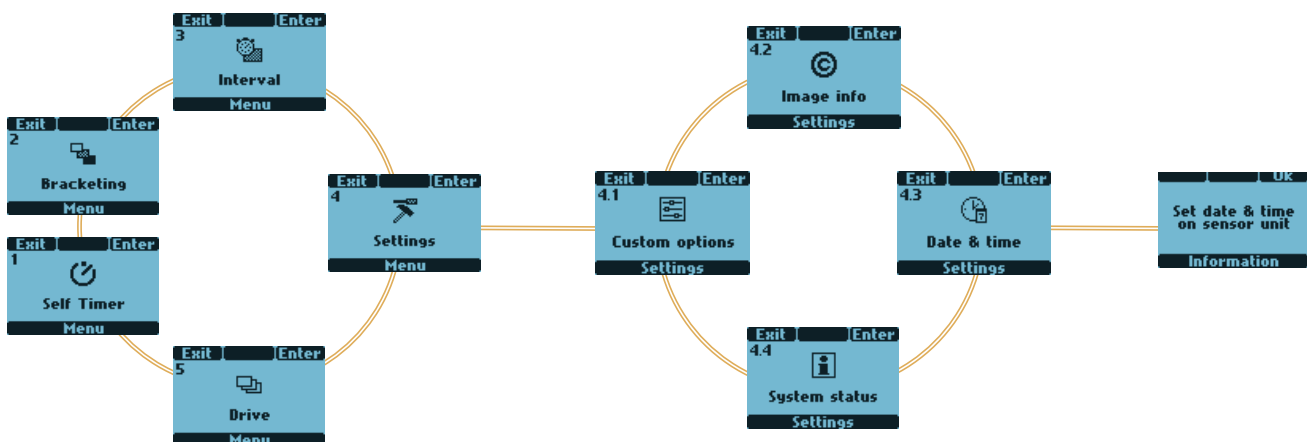

SETTINGS > SYSTEM STATUS

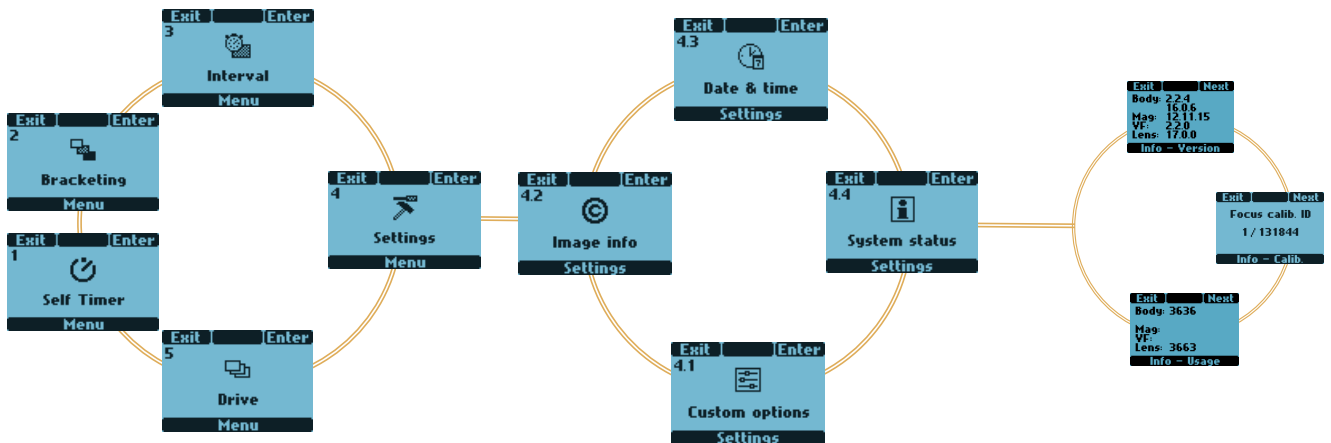

Check component usage and general servicing information as follows:

SYSTEM STATUS DISCLOSURE

- 1) Press **MENU** on grip.
- 2) Turn the **Front** scroll wheel until **Settings** appears.
- 3) Press **ENTER**.
- 4) Turn the **Front** scroll wheel to access **System Status**.
- 5) Press **ENTER**.
- 6) The display now shows a list of camera components **Info-Usage** and to the right of each individual component a figure that represents the number of actions taken by that component. Please note that even a completely new camera will have registered actions as these occur during testing before delivery.
- 7) Press **NEXT** to display **Info-Version** to display the software version for each item. Press the **Next (ISO/WB)** button again to display **Info-Calib** for focus calibration information.

NOTE: Firmware version for film magazine only displayed with film magazine or H5D sensor unit.

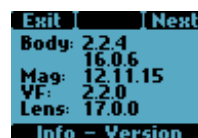

DRIVE

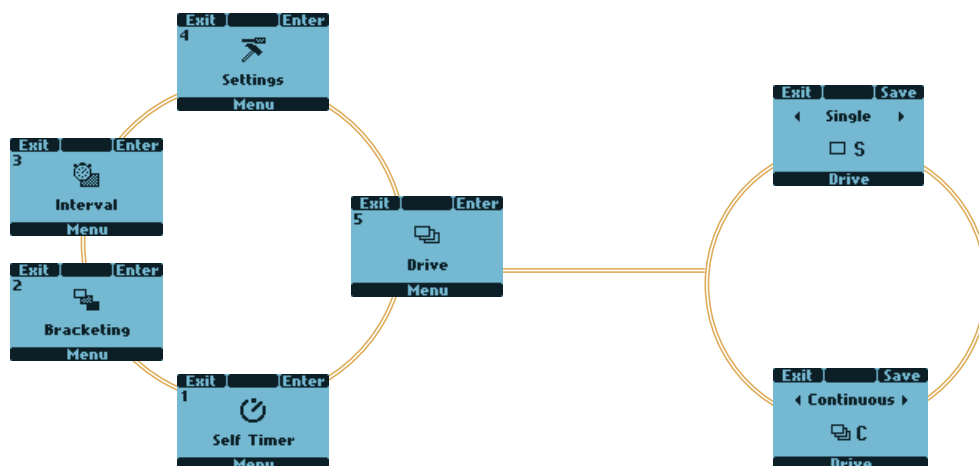

There are two drive modes: **Single** and **Continuous**. In **Single** mode, a capture is made when the shutter release button is pressed and the camera is made ready for the next capture. To make the next capture however, you must first release the shutter release button and then press again.

In **Continuous** mode, the camera automatically makes captures and makes ready for the next capture in a continuous manner as long as you maintain pressure on the shutter release. Please note the speed is dependent on the time taken to save the capture according to equipment.

SINGLE AND CONTINUOUS SETTING

In camera active mode:

- 1) Press **MENU** on grip.
- 2) Turn the **Front scroll wheel** until **Drive** appears.
- 3) Press **ENTER**.
- 4) Turn the **Front scroll wheel** to **Single** or **Continuous**.
- 5) Press **SAVE**.



PROFILES



Photo: Vicente Ansola © / Hasselblad Masters

PROFILES

The profiles feature allows rapid access to pre-determined combinations of settings that increase the speed and security of workflow. One example might be in a social situation where there might be a need for formal outdoor portraiture followed by informal indoor handheld flash-assisted wide-angle shots, both situations requiring very different settings in a stressful environment. By predetermining the relevant settings required beforehand for each situation, they can be saved collectively as a profile. By calling up the profile, you can then be assured that all the settings are correct at the press of one button.

For example, you might choose – autofocus single, bracketing, programmed exposure, etc – for outdoors. Once set, you would click on the red **PROFILES** button, select a profile name and press **SAVE**. A new name can be entered for the new profile - 'Outdoors', for instance - and saved again. New settings are made for the indoor shots changing to flash, Pv setting, etc and the procedure repeated. By simply accessing 'Outdoors' or 'Indoors' in the profile list, all the relevant settings will be instantly and correctly implemented to match the situation.

There are eight profiles: **Default**, **Full auto**, **Studio**, **Fill flash**, two **Action** and two **Spare** reserved for customization. All except **Default** can be changed and renamed.

The pre-set profiles feature the following:

Default: normal flash sync, autofocus (single), single drive, auto exposure (aperture priority), average metering, -None

Full auto: normal flash sync, autofocus (single), single drive, programmed exposure, centre weighted metering, -None

Studio: normal flash sync, manual focus, single drive, manual exposure, spot metering, - AF

Fill flash: normal flash sync (adjusted output -1.7EV), autofocus (single), single drive, auto exposure, average metering.

Spare: customized profiles.

The default setting is highlighted on the display for easy and rapid access. Access to profiles lower on the list is via a scroll bar visible on the right of the display. Rotate the rear scroll wheel to bring them into view.

All user profiles can be restored to default values again simply by removing the battery and holding down the **MENU** and **ISO/WB** buttons on the grip together and while keeping them depressed, replace the battery. There will be an audible signal that denotes the restoration.

There are two ways of making, saving and managing Profiles:

- 1) *Using the buttons on the grip*
- or
- 2) *via the Camera Configuration tool in Phocus (with H5D sensor units only).*

Note

All settings, including those made on the sensor unit, are stored when a profile is created. This includes the ISO, white balance, color temperature and color tint settings that were current at the time the profile was created. These profile settings will override the settings in use at the time the profile button was pressed. In other words, remember to check for unintentional ISO, white balance or color temperature changes when using profiles. (Color tint is not a user setting but is stored after a manual white balance has been made).

MAKING A PROFILE

- 1) Activate the camera and go through the various settings (for example, autofocus, aperture priority, fill flash exposure compensation, etc.) you require for the particular purpose and save them as you go.
- 2) When all the required settings have been made, click (not press!) the **PROFILES** button (**ON.OFF** button) to access the profiles screen.
- 3) Use the scroll bar to go through the list of profiles. Choose a **Spare** profile or a named profile (except **Default**). You can either save the new profile under the original name or you can change it
- 4) Press **Save (ISO/WB)** button). The Profile name screen is then displayed where you can rename the profile to what suits you (see under **Image Info 4.2** for procedure details).

To use a profile from the main screen, press the **PROFILES** button to reach the profiles screen again. Scroll down the list to the profile you want and then press the **Load (AF)** button. All the saved settings will then be automatically implemented.

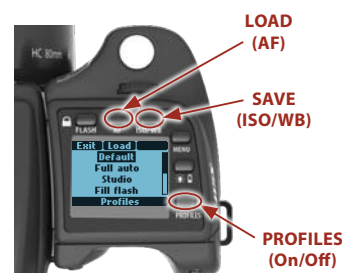

Note

If you decided to change the settings but nevertheless keep the Profile name on the list, the new set of parameters will be retained under that name. That is to say, the settings will not be the same as listed here, despite the name. It might be safer practice therefore to always change the profile name to avoid later confusion.

■ USING PROFILES

- 1) From the main screen, click **PROFILES** on the grip and the profile screen will appear.
- 2) Use the scroll bar to go through the list and highlight the desired profile.
- 3) Press **Load (AF button)**. The camera is now set according to all the parameters stored according to the name.



■ CHANGING A PROFILE NAME

You can change a profile name (except 'Default') at any time.

- 1) From the main screen, click **PROFILES (ON.OFF button)** on the grip and the profile screen will appear.
- 2) Scroll through the list (front or rear scroll wheels) and highlight the desired profile.
- 3) Press **Load (AF button)**.
- 4) Click **PROFILES (ON.OFF button)** again.
- 5) Press **Save (ISO/WB button)** The Profile name screen is then displayed where you can rename the profile to what suits you (see under **Image Info 4.2**).



Tip

To quickly reset all profiles back to the original factory settings:

1. Remove battery.
2. Wait 5–10 seconds.
3. Replace the battery while keeping both the Menu and ISO/WB buttons pressed.

Tip

Profiles and profile creation can be handled in Phocus in a very intuitive way. The Camera Configuration is found in the menu: **Window / Camera Configuration** – for use with H5D sensor units only.

FLASH / STROBE

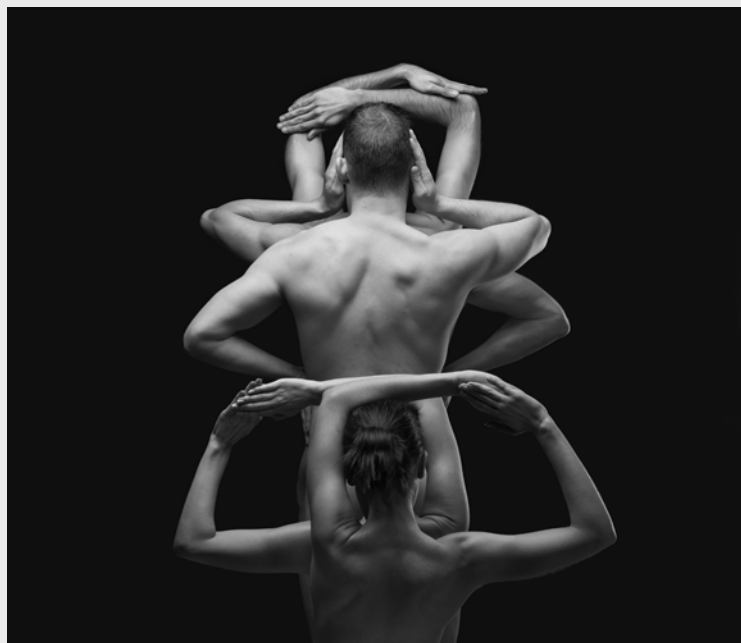

Photo: Olivier Valsecchi © / Hasselblad Masters

FLASH / STROBE

The H6X can be used together with most flash units in manual mode. However, to make use of a TTL automatic function, you must ensure the flash unit is compatible with the SCA 3002 system. Connection is either by the PC socket or by the hot shoe (see warning note below).

The viewfinder houses an integral fill-flash with a guide number of 12 and features OTF/TTL flash control. This back is capable of providing enough illumination for many fill flash functions outdoors as well as simple indoor shots at shorter distances.

Flash output can be adjusted separately from ambient exposure for optimum control.

Separate flash units can be used in dedicated mode when connected to the hot shoe if the back is compatible with the SCA3002 (Metz) system using a Hasselblad SCA3902 adapter. This provides a cable free link up for information transfer.

Flash synchronisation can be set to normal or rear (the beginning or end of a capture).

Please see the relevant user manuals for information regarding separate flash units.

GENERAL

When using the **A** or **S** setting together with flash, the exposure requirements of the camera will dominate which might produce slow shutter speeds indoors, for example, requiring the use of a tripod. If, on the other hand, you select **P** or **Pv** instead, then a shutter speed of 1/60 or faster is automatically chosen by the camera enabling you to hand hold.

When using flash close up or when using larger aperture settings, remember that the flash unit's output has a specific minimum duration which might still be too great for correct exposure. Read the back's output specifications for further information regarding any potential restrictions.

You can use the flash metering capability with external flash units of all kinds (TTL flashes must be set to Manual mode).

Rear sync is a useful feature used either for effect or to produce a more 'natural' look when combining long exposures involving light trails and flash.

When using suitable dedicated backs (compatible with SCA3002), adjustments are made automatically and governed by the settings on the camera. This applies to whether the flash unit is set to TTL or whether it is set to its own integral metering system (A).

Control of either the integral flash unit or separate SCA3002 compatible flash unit regarding the two functions, exposure compensation and shutter sync, is via the grip. The flash measure function can be used for flash units that are not SCA 3002 compatible or for SCA 3002 compatible backs at manual setting.

To change the balance between flash output and camera exposure requirements to produce a variety of effects, use the exposure compensation function. For various long exposure effects use the sync function. To make flash exposure tests use the flash measure function.



Note

Only flash units specially adapted for use with the H6X should be connected to the hot shoe on the camera.

Note

Do not attempt to connect a flash unit dedicated for use with another camera brand via the hot shoe. The flash unit and / or camera could be damaged.

Note

If using flash/strobe as the main light source and 1/800s shutter speed, remember to turn off the True Exposure function (Custom Option #13 on grip).

Note

As with all strobe/studio flash use, very particular attention should be taken to ensure correct connections and general handling practice. Potential dangers might increase when cameras are also connected to electronic peripherals (computers, lighting backs, etc) and should diminish when IR and similar wireless flash release devices are used.

Victor Hasselblad AB can accept no responsibility whatsoever for accidents that might occur or damage caused when Hasselblad equipment is used in combination with third-party backs of any description.

■ ACCESS TO CONTROLS

1. Activate the camera and press the **FLASH** button once.
2. Turn the **Front** scroll wheel to set the amount of compensation required:
 - from +3EV through -3EV
 - press **Clr** to clear the setting quickly if required.
3. Turn the rear scroll wheel to set:
 - **normal sync** (flash triggered just after the shutter opens)
 - **rear sync** (flash triggered just before the shutter closes)
 - **flash measure** (with non-TTL flash units or TTL backs in Manual mode)
4. The grip display shows the flash mode – **Normal** or **Rear** – in the standard display.
5. When set to **Flash Measure**, a specific screen requests you to press the **AE-L** button in order to make a reading. See below for details.

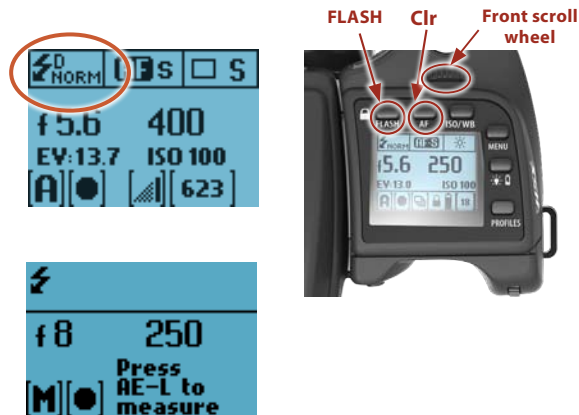

[-1.0 EV] Flash Rear

Example of viewfinder display showing Flash set to Rear sync as well as '-1EV' exposure compensation.

■ INTEGRAL FLASH

The integral flash unit features the following specifications:

Guide no.	12
Coverage	56° horizontal, 44° vertical
Maximum light fall-off at side centres	- 1EV (50%)
Color temperature (full flash)	5,000 – 5,600° K

To raise the flash unit into its operative position, slide the flash-back catch backwards in the direction of the flash symbol. To return the flash unit into its closed position, push down on the top of the back until it clicks back into place. The flash unit is automatically activated when it is in the operative position and de-activated when returned to its stored position.

The green LED flash symbol blinks in the viewfinder when the flash unit is charging and remains stationary when fully charged. The flash output can also be adjusted for optimum light balance in fill-flash situations.

Using the integral flash:

- 1) Slide the flash-back catch backwards in the direction of the flash symbol.
- 2) Press **FLASH**.
- 3) Choose between **Normal** or **Rear** sync by turning the **Rear** scroll wheel and the amount of compensation (if required) by turning the front scroll wheel.
- 4) Press **Save**. Make an exposure.
- 5) If the settings were incorrect to match the output of the flash unit, the viewfinder display shows a red triangle alongside a flashing green 'flash' symbol plus a warning message - **'Low flash'**. The grip display will also show a warning message - **'Low flash'**.

Conventional measures should then be taken to correct the situation. (That is: move closer to the main subject, use a larger aperture setting or use a higher ISO setting).



Note
Do not use the integral flash together when another external TTL flash unit is connected (and used in TTL or A mode).

Note
For full coverage with the integral flash, use 80mm or longer lenses (without a lens shade).

SEPARATE FLASH UNIT CONNECTION

Separate flash units can be electrically connected either by way of the hot shoe accessory holder (see previous warnings) on the top of the viewfinder or via a cord to the PC connection port on the left hand side of the camera body. Slave unit switches/ transmitters can also be connected similarly dependant on unit (see specific user manuals for details).

Keep the plastic safety cover in place in the hot shoe when not in use.

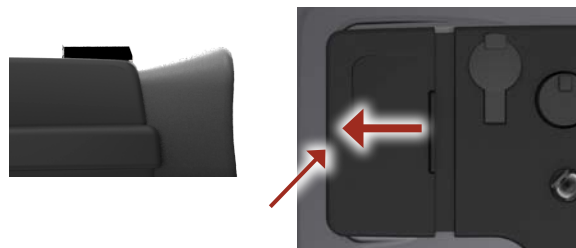

Lift this edge of the cover first

FLASH MEASURE OF SEPARATE FLASH UNIT

You can measure the effect of an attached flash unit (with PC connected flash units and SCA3902 compatible flash units set to **M** mode), where the camera acts much as a flash meter would. The aperture setting can be adjusted and more trial exposures made until the information on the grip display is satisfactory.

To use flash measure:

- 1) Press the **FLASH** button on the grip to access the flash option screen.
- 2) Turn the **Rear** control wheel until **Flash measure** appears.
- 3) Press **Save** (**ISO/WB** button) to access the flash exposure screen.
- 4) Make preliminary required aperture setting by turning the front control wheel.
- 5) Press the **AE-L** button. The camera will close the aperture, raise the mirror and fire the flash. Light reflected from the flash lit subject will be reflected off a white spot on the auxiliary shutter to the meter sensor.
- 6) Deviations from a normal exposure are displayed as differences in EV on the grip display and the viewfinder display. If 'high' or 'low' appears, change the aperture accordingly and make a new test reading.

Change the aperture until **Diff EV: 0** appears, or the desired amount of deviation from the normal exposure.

Diff EV: Low signifies more than 2 EV under

Diff EV: High signifies more than 2 EV over

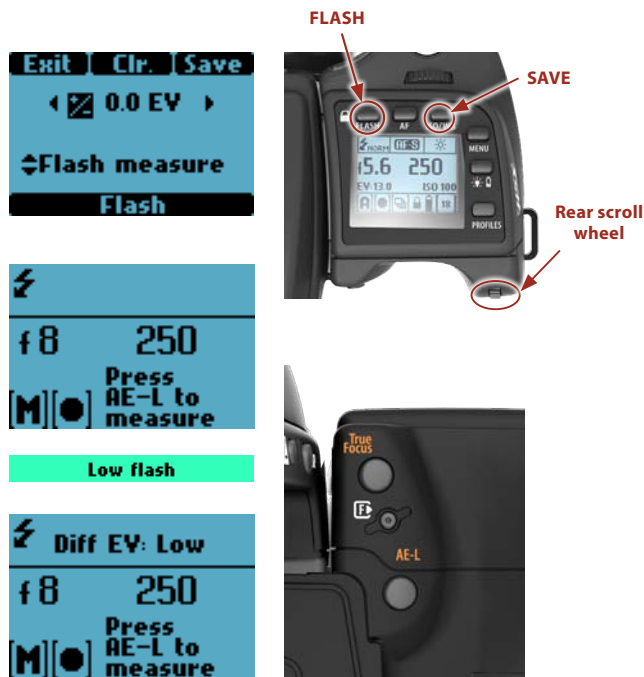

Tip

The 'Low Flash' warning can be turned off in Custom Option #26 if preferred.

ACCESSORIES



Photo: Miłosz Wozaczynski © / Hasselblad Masters

CONNECTIVITY DIAGRAM

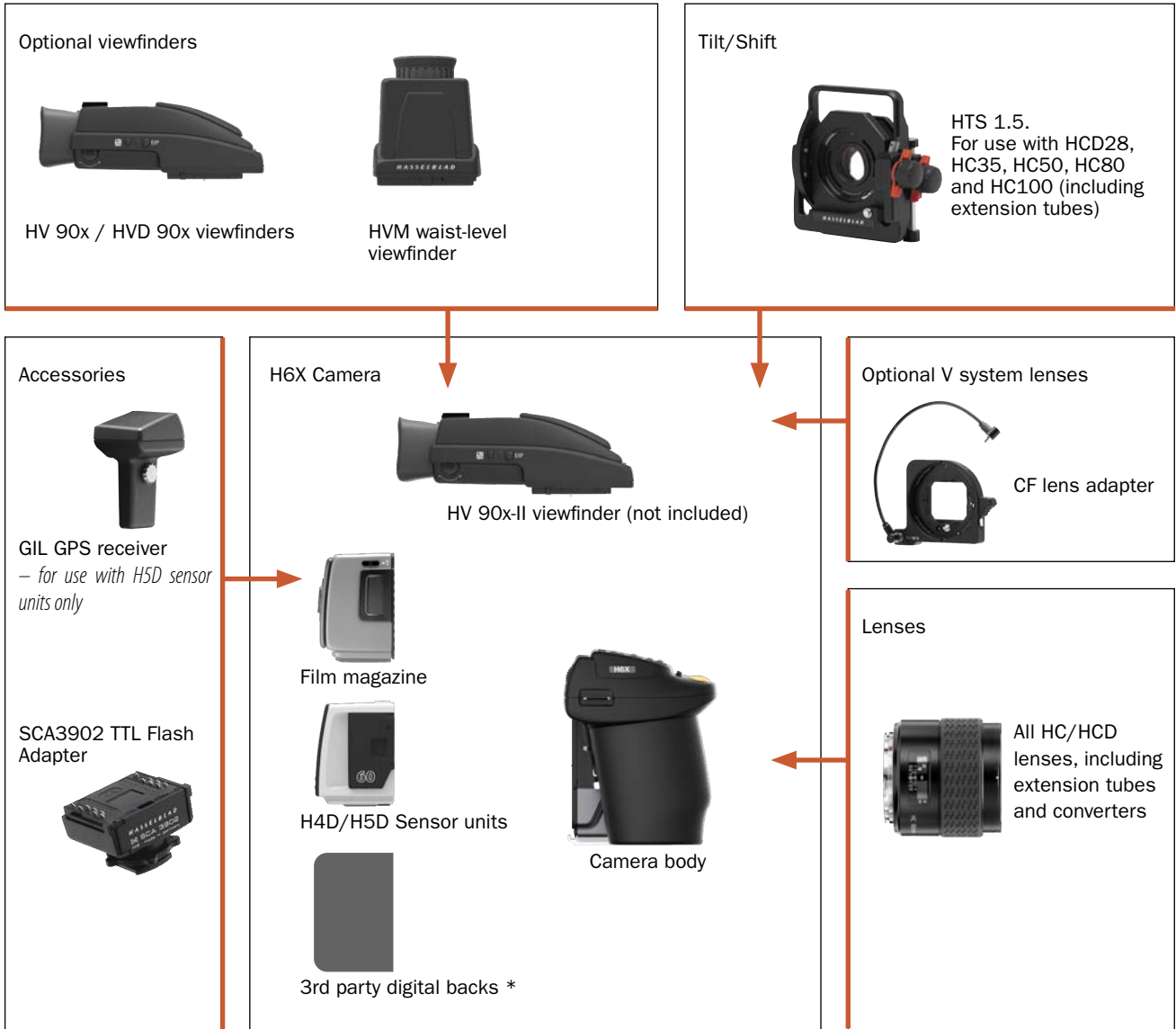

* Same functionality as H5X Cameras

HC LENS RANGE



HCD 4.8/24mm



HCD 4/28mm



HC 3.5/35mm



HC 3.5/50-11mm



HC 2.8/80mm



HC 2.2/100mm



HC Macro 4/120-11mm



HC 3.2/150mm



HC 4/210mm



HC 4.5/300mm



HC 3.5-4.5/50-110mm



HCD 4.0-5.6/35-90mm

Most V system C type lenses with optional CF lens adapter



OPTIONAL ACCESSORIES



HVM waist level viewfinder

(3053328)

The HVM waist level viewfinder allows a comfortable lower viewing angle either for effect or where eye contact with the subject is desirable in portrait photography, for example. Autofocus function of all lenses fully retained. Optimized for horizontal format shooting and not suitable for vertical format use.



HVM correction lens holder

(3053348)

Lens holder for custom made eyesight correction (lenses available from opticians). To be used for optimal viewing comfort and accuracy.



Proshade V/H 60 – 95

(3040740)

An adjustable bellows lens shade that provides highly efficient protection against stray light. Its compact, flat folding design saves space in the equipment case. With adapters fits all HC lenses and virtually all V system lenses. Also features a filter holder for glass, gelatin, or plastic filters.



Proshade adapters

(3043415, 3043417, 3043419)

67mm, 77mm and 95mm adapters with bayonet mount for HC lenses. Features lock to provide positive and secure attachment.



GIL (Global Image Locator)

(3053300)

The Hasselblad GIL (3053300) provides automatic creation and storage of GPS information for all H-system digital cameras. The data is tagged to each individual image file and can be read directly by Phocus. The back requires no extra external battery or power source and works seamlessly in the background for ease of use – for use with H5D sensor units only.



Tripod quick coupling H

(3043326)

Mounted on a tripod, this accessory facilitates rapid attachment and removal of the camera. The camera is firmly held in an exact and repeatable position. Two integrated spirit levels make horizontal positioning of the camera easy. The Tripod quick-coupling H fits 1/4" and 3/8" tripod threads and has a safety catch.



Flash adapter SCA 3902

(3053393)

For connecting flashes compatible with the SCA 3002 system to the Hasselblad H6X.



UV-sky filters

(3053470, 3053474 and 3053478)

Absorbs UV radiation and reduces blue haze without affecting colors. Also protects the front lens surface. Particularly recommended when the camera is used in harsh conditions. Available in three sizes to suit various lenses: UV-sky 67mm (3053470), UV-sky 77mm (3053474) and UV-sky 95mm (3053478).



Pola filters

(3053482, 3053486 and 3053490)

Reduces non-specular reflections and glare. Increases color saturation in general. Can intensify a blue sky. Available in three sizes.



Support strap with Quickplate H

(3045154)

Improves comfort and security with hand-held photography. Complete with quick plate H.



Camera strap H

(3053616)

Extra wide camera strap with anti-slip backing.

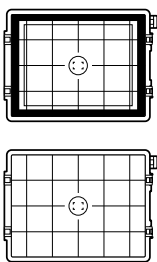

Focusing screens

All focusing screens are of the Spherical Acute-Matte D type with or without grid and central markings for spot (\varnothing 7.5) and AF metering area. Grid patterns provide aid in technical, architectural, documentation and other similar fields.

Available with or without masking for the sensor format.

Release cord H

(3043370)

Remote release cord with a cable length of 0.5 m.



HVD 90x / HV 90x & 90x-II viewfinders

(3053330, 3053326, 3053334)

90 degrees reflex viewfinder, providing 100% field of view even when wearing eyeglasses. Includes built-in fill flash and multi-mode light metering system.

Angle finder H

(S100A12359A00)

Angle finder for the HV 90x and the HVD 90x viewfinders. Enables vertical viewing angle regardless of camera position. Requires a minor modification to the viewfinder eyepiece.



DC power grip

(3043350)

Removable H-camera grip with AC power adapter for supplying camera power from domestic mains supplies.



OPTIONAL HC LENS ACCESSORIES



HTS 1.5

(3043400)

The HTS 1.5 is a shift and tilt adapter designed for the HCD28mm, HC35mm, HC50mm, HC80mm and the HC100mm lenses. It not only solves technical challenges but also provides exciting opportunities for creative solutions.



Converter H 1.7X

(3023717)

The Converter attaches between the lens and the body to increase the focal length by a factor of 1.7. This provides a convenient way to expand your range of lenses. The Converter H 1.7 X features the same outstanding optical and mechanical quality as all the lenses in the Hasselblad H system. The optical design consists of 6 elements in 4 groups.



CF Adapter

(3043500)

The CF adapter allows virtually all lenses from the V-system to be used on H-system camera bodies. This automatically expands the potential lens range for H cameras by more than a dozen different focal lengths.



Macro Converter H

(5023720)

The Macro Converter is designed to improve the close range performance of wide angle H system lenses. Although primarily aimed for use in conjunction with the HC 50-II lens for optimum performance, it can also be used with any of the other H system wide angle lenses.



H 13, 26 and 52 Extension tubes

(3053513, 3053526 and 3053542)

The Extension tubes attach between the lens and the body to reduce the close focusing distance for close up photography. They are available in three sizes: 13 mm, 26 mm and 52 mm. As the H6X has a TTL light metering system, exposure compensation is automatic.

Check www.hasselblad.com for further details about lens shades, endcaps, lens pouches etc or news of new accessories.

APPENDIX



Photo: Jon Lowenstein © / Hasselblad Masters

TECHNICAL SPECIFICATIONS

Camera Type	Auto-focus, auto-exposure SLR camera with interchangeable viewfinders and lenses.
Construction	One piece stainless steel shell. Die-cast aluminium internal structure. Tripod sockets (1/4 and 3/8") and quick coupling tripod plate for rapid mounting.
Lenses	Hasselblad HC/HCD lenses with built-in electronically controlled shutter and aperture. Automatic or manual focusing with instant manual focus override. All HC/HCD lenses meet the exacting requirements of digital photography. Lens shades can be mounted in reverse for transport. V- system lenses can be used with a CF adapter.
Viewfinder (HV 90x-II)	A 90° reflex viewfinder, providing 100% field of view even when wearing eyeglasses, and built-in multi-mode light metering system. Image magnification 3.1x. Integrated fill-in flash with guide number 12. Hot-shoe for automatic flash (Metz SCA3002 system / adapter SCA3902). Dot matrix display with presentation of all relevant information. Built-in diopter adjustment from -5 to + 3.5D. Interchangeable.
Focusing	Automatic and manual focusing with electronic focus aid in manual mode. Instant manual focus override. Automatic focusing using passive central cross type phase detection sensor. AF metering range EV 1 to 19 (ISO 100).
Shutter	Electronically controlled lens shutter with speeds up to 1/800. Flash sync at all speeds.
Flash control	TTL centre-weighted system. Can be used with the built-in flash or a wide variety of flashes compatible with the SCA3002 (Metz) system using adapter SCA3902. ISO range 16 to 6400. Flash output can be adjusted (-3 to +3EV) for fill-in purposes independent of ambient light. Synch at all shutter speeds.
Flash measurement	The H6X has a built-in measurement system that measures flash light from non-TTL flashes, such as studio flashes.
Exposure metering	Multi-mode exposure metering using 90° reflex viewfinder. Metering options are: Spot (diameter 7.5 mm), Centre Weighted, and CentreSpot. Metering range at f/2.8 and ISO100: Spot: EV2 to 21, Centre-weighted: EV1 to 21, CentreSpot: EV1 to 21.
Auto bracketing	Bracketing using predetermined number of captures (2, 3, 5, 7 or 9) in 1/3, 1/2, or 1 EV step difference intervals.
Interval timer	Number of captures from 2 to 'no limit' and interval from 1 second to 1 hour.
ISO range	Dependent on sensor unit.
Displays	The camera features two dot-matrix displays that provide clear and easy-to-understand information to the user. One is located on the grip and the other in the 90° viewfinder.
Focusing screen	Bright Spherical Acute-Matte type D with sensor format markings. Grid marked type also available as option.
Compatibility	All H System lenses and accessories. V system C type lenses with optional CF lens adapter.
Accessory connection	Provided with two M5 threads and an electrical connector for accessories.
Customization	A large number of the H6X's functions can be customized by the user to suit specific styles or situations through the built-in menu system.
User interface	Both basic and advanced functions are set using buttons and scroll wheels in conjunction with the grip display and viewfinder display.
Rechargeable battery grip Li-ion	3200 mAh output.
External dimensions	Camera body: 154 x 114 x 89 mm [W x H x L].
Weight	Camera body with battery grip and viewfinder: 1170g.

DEFAULT SETTINGS (DEFAULT PROFILE)

GENERAL	Exp.mode	A (Aperture priority)	
	LM mode	Centre weighted	
	Exp. adjust	0	
	Focus mode	AF-S	
	Drive mode	S	
	Flash sync	Normal (beginning of exp.)	
	Flash adjust	0	
SELF TIMER	Delay	10 sec	
	Sequence	Mirror up / Delay	
	Mirror mode	Mirror goes down	
BRACKETING	Frames	3	
	Sequence	Normal - over - under	
	EV diff	0,5 EV	
INTERVAL TIMER	Frames	3	
	Interval	0 min 30 sec	
CUSTOM OPTIONS	1	Display Off	10 sec
	2	EV increment 1/2 step	(0.5 EV)
	3	Exp adjust increment 1/3 step	(0.3 EV)
	4	True Focus button function	True Focus
	5	AE-Lock button function	AE-lock
	6	Stop Down button function	Stop down
	7	M.UP button function	Mirror up
	8	Control wheel direction	CW
	9	Flash ready exposure lock	Yes
	10	Magazine exposure lock	Yes
	11	Lens exposure lock	Yes
	12	Out of range exposure lock	No
	13	True exposure	On
	14	Spot mode	Normal
	15	Focus aid in MF	Half press
	16	AF assist light	Camera
	17	Rear wheel quick adjust	Yes
	18	Control lock	All controls
	19	Film Wind-on	Half press
	20	Beeper	On
	21	Show histogram	Yes
	22	Interval & Self timer	Exit
	23	AE-lock & Quick adjust	Exp. reset
	24	Show EV	Yes
	25	Show ISO	Yes
	26	Bracket param. in Manual	Shutter speed
	27	Aperture control in Manual	Front wheel
	28	Low flash warning	On
	29	Interval timer initial delay	None
	30	Aperture indicator	Normal
	31	Extra mirror-delay	50ms
	32	True Focus in AF-S	Off
	33	Always return mirror	No
	34	AE lock at half press	Off
	35	Hide B/T mode	Off

LIGHT METERING METHOD SENSITIVITY DISTRIBUTION

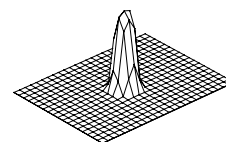
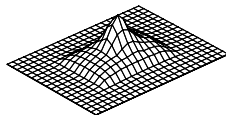
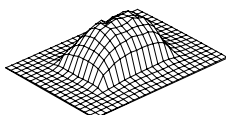

TRUE EXPOSURE

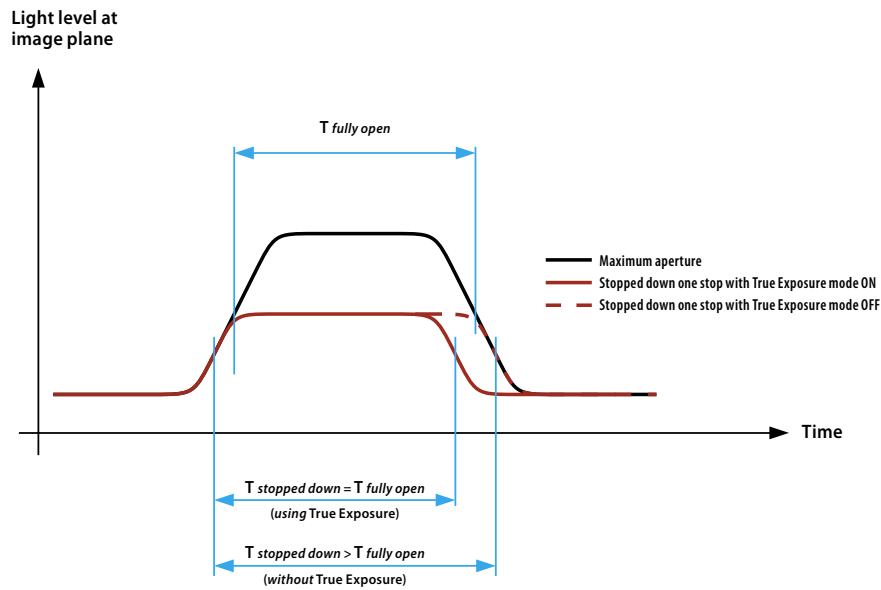

True Exposure is an HC/HCD lens function that allows the shutter speed to remain un-affected when stopping down. This effect is perhaps not so commonly understood as it is restricted specifically to integral lens shutters as opposed to focal plane shutters.

As compensation can only be put into effect where speeds can be adjusted, this prevents the possibility of adjusting the fastest speed of 1/800s. To counter this, compensatory adjustments are therefore made to the aperture instead to retain the set exposure.

When a lens is stopped down, the effective shutter speed becomes longer, consequently affecting the set exposure. At slow shutter speeds the effect is minimal but at faster speeds, e.g. 1/500s, the effect becomes clearly visible. As Hasselblad knows exactly how the shutters behave in HC lenses, automatic compensatory measures in speed setting adjustments are therefore employed.

However, this compensation is not always required and when using flash/strobe as the main light source it is actually undesirable because compensation will result in underexposure. Therefore, when using flash/strobe as the main light source, you should set **True Exposure** to **OFF** in **Custom Options #13** on grip.

You can download a fuller explanation of this situation from www.hasselblad.com.

AUTOMATIC EXPOSURE – P & PV MODE

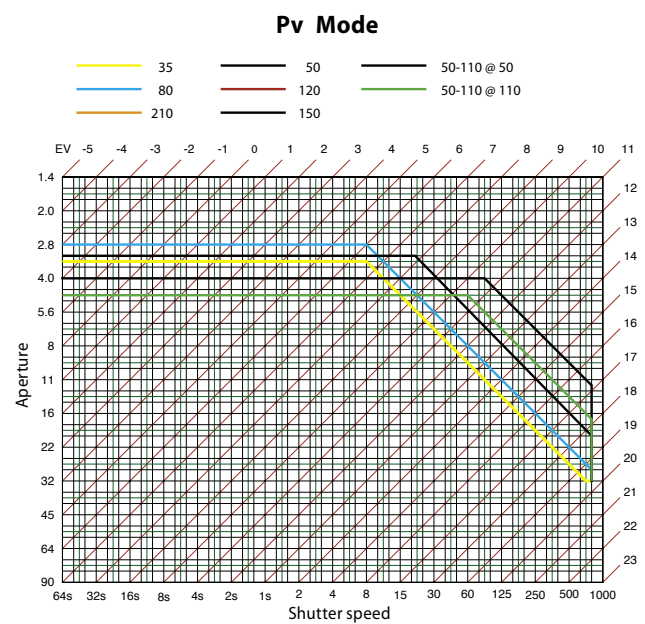
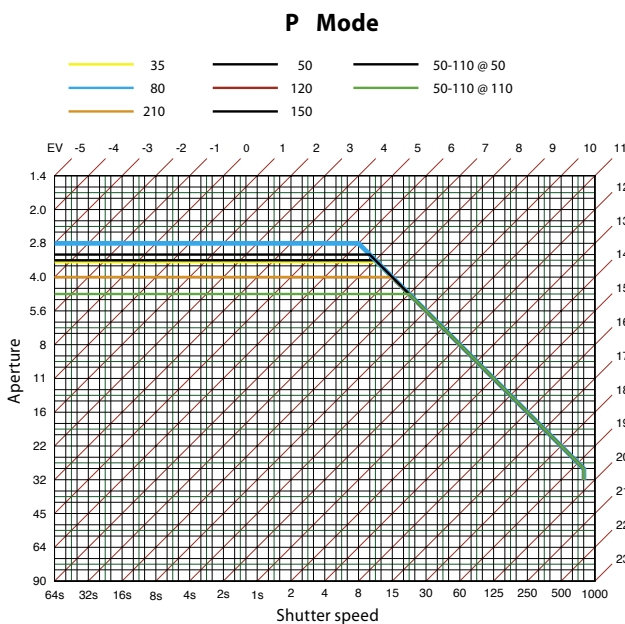

PROBLEMS, EQUIPMENT CARE & SERVICE

The H6X is a very sophisticated camera that relies on much information being passed and processed to and from each modular back to produce the correct behavior. It is therefore essential that reasonable care is taken in attaching, detaching and storing the viewfinder, lenses, extension tubes, etc to ensure that the databus connections are not damaged or soiled in any way. Also when lifting or handling the camera try to always use the grip or strap and avoid holding the camera just by a sensor unit/film magazine or viewfinder.

Warning messages are normally easily addressed and remedied but 'Error' messages require further attention as they denote a fault, temporary or otherwise. You should methodically investigate the situation to see for example whether the recent attachment of an accessory has coincided with the appearance of an error message. Standard procedure is to detach and re-attach the viewfinder, lens etc ensuring that they are positioned firmly and correctly to see whether the problem disappears. Failing that, removal of the battery grip for about ten seconds or so will reset the camera's processors. Persistent error messages might well signify a more complex problem and you are advised to contact your nearest Hasselblad Authorized Service Center for advice. You may receive a feedback report on either the grip display or a digital back display. Please note this message carefully as it can facilitate support response greatly, as well as improve on firmware updates. As well as the error message, a description of the camera's behavior and an account of what action you were trying to take when it happened could be also beneficial. Also, please remember that if a hardware check is to be made, the Center will almost certainly want to inspect all of the items that were involved when the error message first appeared.

In certain situations, it is possible that the camera can be affected by a discharge of static electricity particularly if the area around the control buttons on the grip comes into contact with a conductive cord or material that is connected to earth, directly or indirectly (a lighting stand, for example). This might temporarily deactivate the camera though it does not cause any damage. Press the red ON.OFF button on the grip again to reactivate the camera.

If a problem does occur you are advised not to attempt any repairs yourself. Some service operations require very sophisticated instruments to check, measure and adjust and there is a real danger of creating more problems than solving them if such attempts are made in any other way.

EQUIPMENT CARE

A Hasselblad camera is designed to withstand the rigors of professional use in most environments. To avoid the possibility of damage however, it should be protected from harsh conditions and in particular avoid oil fumes, steam, humid conditions and dust.

Extremes of temperature: High temperatures can have an adverse effect equipment. Avoid frequent and severe temperature changes and be particularly careful in humid environments. If entering damp or humid conditions from dry and cold conditions, seal all equipment in a plastic bag or similar first before entering and then wait until the equipment has acclimatized to the new temperature before removing. Failure to do so can cause condensation internally as well as externally which can lead to problems particularly in regard to sensor units. Try to ensure the environment or conditions are as dry as possible when storing.

Dust and grit: Take care to prevent dust and grit from getting into your equipment. In coastal areas take measures to protect your equipment from sand and salt water spray. Dust on the lens glass and focusing screen can be removed with a blower brush or very soft lens brush if necessary. Smears on the lens glass should be treated with great caution. In some cases they may be removed with a high quality lens cleaning solution on a tissue but be careful not to scratch the lens or touch any of the glass surfaces with your fingers. If in any doubt, do not attempt to clean lens glass surfaces yourself but allow a **Hasselblad Authorized Service Center** to treat them.

Impact: Your equipment can be damaged by severe physical shocks so practical protective precautions should be taken. Some form of protective case or camera bag is advised for transportation.

Loss: Hasselblad equipment is much sought after and you should take obvious steps to prevent theft. Never leave it visible in an unattended car, for example. Separate and specific camera insurance cover should be considered by professional users.

SERVICE

Return your equipment to a service centre for occasional checking and preventive maintenance to ensure optimal reliability. You can easily keep a check on service intervals by looking under 'Info' in the menu. If your camera is used constantly and intensively, regular periodic check-ups are recommended at one of the **Hasselblad Authorized Service Centers**. They have the expert staff and specialised equipment necessary to ensure that your equipment remains in perfect working order.

CAUTION

- Keep all equipment and accessories out of the reach of small children.
- Do not place heavy objects on the equipment.
- Do not use the batteries except as specified.
- Use only the batteries specified for use with the camera.
- Remove the batteries when cleaning the camera or if you intend to leave the camera unused for a long period.
- If you use spare (standard or rechargeable) battery packs be particularly careful to use the supplied protective cap when storing. There is a potential fire risk if the contacts are short circuited across a conductive object (such as keys in a pocket, for example).
- Take particular care when working with strobe / studio flash units to prevent damage to equipment and personal injury.
- Do not attempt to open the sensor unit.
- Keep the sensor unit and all other computer equipment away from moisture. If the sensor unit becomes wet, disconnect from power and allow it to dry before attempting to operate again.
- Never cover the ventilation openings on the sensor back.
- Always replace the protective CCD/filter cover when the sensor unit is not connected to the camera.
- Never try to remove the glass IR filter from the front of the CCD; this will probably ruin the CCD. If dust manages to get between the CCD and IR filter, please contact your Hasselblad dealer for assistance.

Disposal of Waste Equipment by Users in Private Households in the European Union



This symbol on the product or on its packaging indicates that this product must not be disposed of with your other household waste. Instead, it is your responsibility to dispose of your waste equipment by handing it over to a designated collection point for the recycling of waste electrical and electronic equipment. The separate collection and recycling of your waste equipment at the time of disposal will help to conserve natural resources and ensure that it is recycled in a manner that protects human health and the environment. For more information about where you can dispose of your waste equipment for recycling, please contact your local city office, your household waste disposal service or the retailer where you purchased the product.

INDEX

A			
Accessories	71	F	
Accessory connection	19	Fixed Exposure compensation	46
AE-L button	45	Flash /strobe	67
Appendix	76	Flash measure	70
Attaching /removing sensor unit	18	Focus assist	33
Attaching /removing the viewfinder	19	Focus checking	38
Attaching/removing a lens	32	Focusing distance calculation	32
Autofocus	35	Focus modes	31
Automatic exposure mode	44	Formatting CF cards	29
B		G	
Battery charger	16	Grip buttons & controls	7
Battery grip – precautions	16	I	
Battery life	17	Infrared focus settings	33
Battery status	17	Integral flash	69
Battery warning	17	Interval	54
Bracketing	52	ISO & WB	42
Buttons, parts, components	6	L	
C		Lens cap	32
Carrying strap	15	Lens shades	32
CF cards	29	Light metering modes	42
Continuous	36	Light metering sensitivity	78
Controls and displays	9	M	
Custom Options	55	Manual exposure mode	48
D		Manual focus	35
Date & Time	61	N	
Default settings	78	Navigating the Menu	48
Depth-of-field preview	33	P	
Display	9	PC-connector	19
Drive	36	Phocus	30
E		Problems	80
Equipment care	80	Profiles	64
Exp compensation/Quick Adjust	46	Protective baseplate	18
Exposure control	41	Power modes	17
Exposure setting modes	43	R	
Eyepiece adjustment	19	Reassignable grip buttons	12
		Recommended CF cards (H5D only)	29
		Removing a lens	32
		Removing/attaching sensor unit	18
		Rubber eyecup	19
		S	
		Self Timer	50
		Settings	55
		Shortcuts	13
		Shutter and aperture control	41
		Single shot	36
		Strobe	67
		System requirements	5
		System status	62
		T	
		Technical Specifications	77
		Text setting - image info	60
		True Exposure	79
		True Focus	36
		True Focus and camera handling	38
		True Focus, Absolute position lock	37
		True Focus, four methods	39
		V	
		Viewfinder	19
		Viewfinder display	18
		Viewfinder screen	18
		W	
		Warnings & restrictions	5
		ISO & white balance	42

The information in this manual is furnished for informational use only, is subject to change without notice, and should not be construed as a commitment by Victor Hasselblad AB.

The images in this manual were not taken with a Hasselblad H6X. They are used for illustrative purposes only and are not intended to represent the image quality produced by a Hasselblad H6X.

The text in this manual cannot be reprinted or reused without the express permission of Victor Hasselblad AB.

The images in this manual cannot be reprinted or reused without the express permission of the photographers who took them.

All text in this manual : © Victor Hasselblad AB.

All images in this manual not credited to a specific photographer:
© Victor Hasselblad AB.

Victor Hasselblad AB assumes no responsibility or liability for any errors or inaccuracies that may appear in this manual.

Victor Hasselblad AB assumes no responsibility or liability for loss or damage incurred during or as a result of using Hasselblad software or products.

Hasselblad, Imacon, Ixpress, Phocus, Phocus Mobile, Phocus Quick and FlexColor are trademarks of Victor Hasselblad AB. Adobe and Adobe Photoshop are trademarks of Adobe Systems, Inc. Macintosh, Mac OS, iPhone®, iPad® and iPod Touch® and FireWire are registered trademarks of Apple Computer, Inc. InfoLithium is a registered trademark of Sony Corporation. Canon, Nikon, Leica, Sony, Fuji and Olympus are trademarks of their respective corporations. Qp Card is a trademark of Qp Card AB. E-Wipe is a trademark of Photosol Inc.

Copyright © 2018

Victor Hasselblad AB

All rights reserved.

H A S S E L B L A D
CREATE TO INSPIRE