

OLYMPUS OM-1 INSTRUCTIONS



DESCRIPTION OF CONTROLS

Refer to pages in parentheses for detailed explanations of each part.

Mirror Lock-up Lever (P. 29)

Rewind Release Lever (P. 10)

Shoulder Strap Eyelet

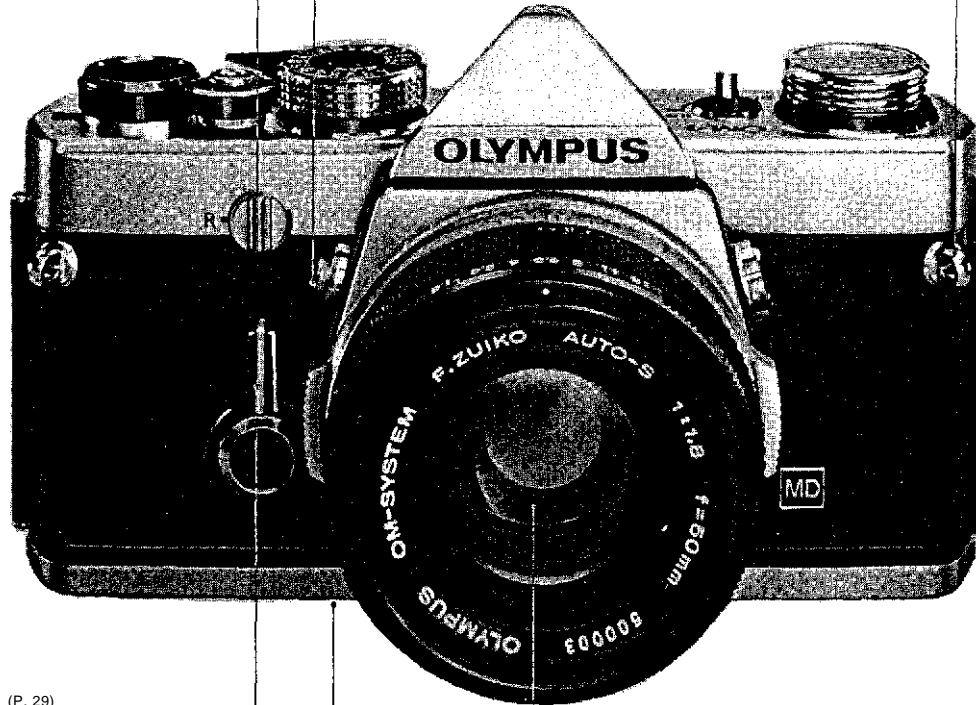

Self-Timer (P. 29)

Preview Button (P. 17)

(P. 16) Standard Lens



DESCRIPTION OF CONTROLS

The design of the OLYMPUS OM-1 lets you see every camera control from the top.

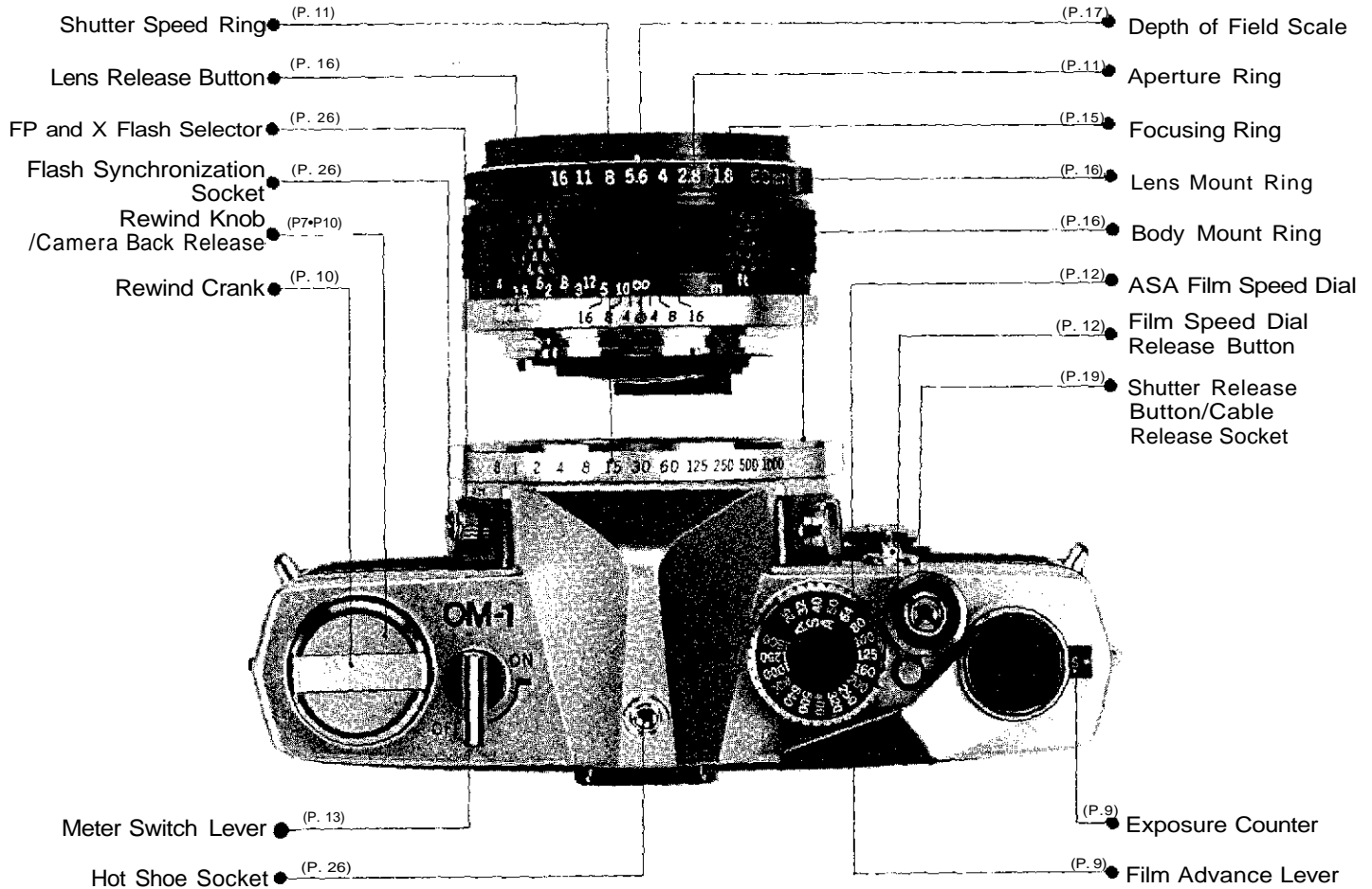

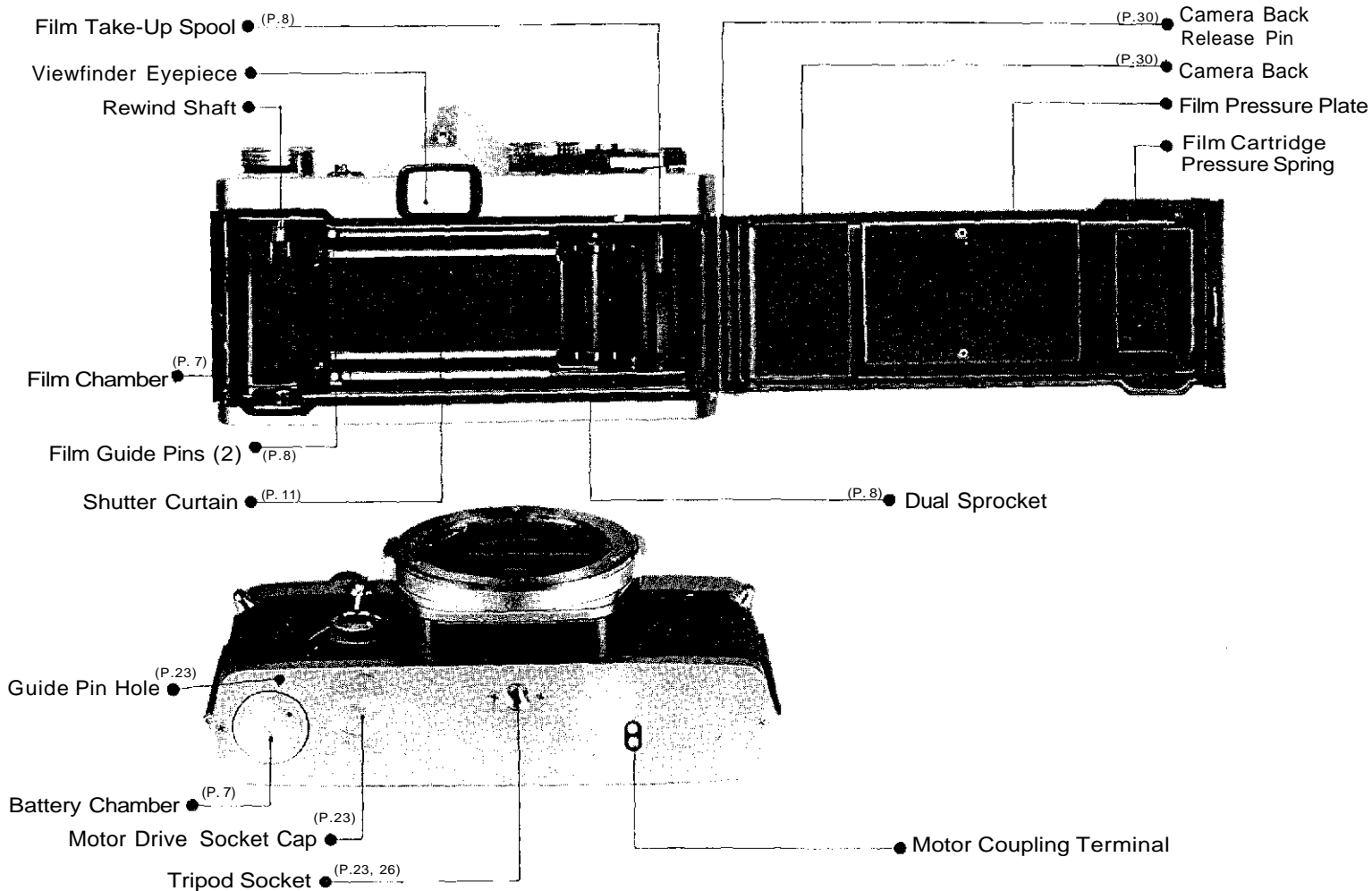



TABLE OF CONTENTS



On OM-1

- Description of Controls 1
- Specifications 5
- Short Course of Instructions 6
- Inserting the Battery 7
- Loading the Film 7
- Front Lens Cap 7
- Operating the Film Advance Lever . 9
- The Exposure Counter 9
- Unloading the Film 10
- Making Double Exposures 10
- Setting the Shutter Speed Ring . . 11
- Setting the Aperture Ring 11
- Setting the ASA Film Speed Dial . 12
- The Metering System 12
- Setting the Exposure 13
- Focusing 15
- Changing the Lens 16

- Infrared Photography 17
- Depth of Field Scale 17
- Preview Button 17
- Depth of Field 18
- Holding the Camera 19
- Interchangeable Focusing Screens . 20
- Motor Drive Photography 21
- Operation of Winder 1 22
- Operation of Basic Motor Drive
Package 23
- Flash Photography 26
- Setting the Self-Timer 29
- Locking up the Mirror 29
- Changing the Camera Back 30
- Questions and Answers 31
- Care and Storage 32

On OM System

- Zuiko Interchangeable Lens Group 33
- Table of Interchangeable Lenses. . 35
- Interchangeable Lens Group Units 37
- Motor Drive Group 38
- Motor Drive Units 41
- Finder Group and Units 43
- Flash Photo Group 45
- Flash Photo Group Units 48
- Macrophotography Group 51
- Macrophotography Units 54
- Photomicrography Group 59
- Photomicrography Units 62
- Chart of Photographic Ranges . . 64
- Phototechnical Group 65
- Phototechnical Units 68
- Case Group 69
- Case Units 69

OLYMPUS OM-1 SPECIFICATIONS

Specifications subject to change without notice.

System:	OLYMPUS OM SYSTEM.
Camera Type:	35mm Single Lens Reflex with focal plane shutter.
Film Format:	24mm x 36mm.
Standard Lenses:	50mm F1.8 F Zuiko Auto-S 6 elements in 5 groups. 50mm F1.4 G Zuiko Auto-S 7 elements in 6 groups. 55mm F1.2 G Zuiko Auto-S 7 elements in 6 groups.
Lens Mount:	OLYMPUS OM Mount, bayonet type, rotation angle 70°, flange back 46mm.
Minimum Focusing Distance:	45cm (17 3/4") with all standard lenses.
Lens Accessory Size:	49mm threaded for F1.8 and F1.4 lenses; 55mm threaded for F1.2 lens.
Shutter:	Focal plane shutter, ring mounted control, with speeds from 1 to 1/1000 second plus B:
Self-Timer:	4—12 second delay lever type; can be stopped and reset after actuation.
Exposure Measurement:	Two highly sensitive CdS cells located on either side of the eyepiece provide through-the-lens open aperture light measurement. Zero-method with needle visible in viewfinder. On-Off Switch located atop camera.
Exposure Range:	EV 2—17 (ASA 100 with F1.4 standard lens).
Battery:	1.35 volt mercury battery (Eveready or UCAR EPX625, Mallory PX625, or equivalent)
Film Speed Range:	ASA 25-1600.
Viewfinder:	Pentaprism type wide-vision finder shows 97% of actual picture field; Interchangeable focusing screens; Visible exposure meter needle.
Viewfinder Magnification:	0.92X at infinity with standard 50mm lens.
Viewfinder Apparent Field View:	23° 30' & 35°.
Focusing Screens:	1-13 Microprism/split image-matte type provided. Interchangeable with any of 12 additional screens.
Reflex Mirror:	Oversize, quick return type with mirror lock-up control.
Flash Contacts:	FP·X switch type contact.
Flash Synchronization:	With electronic flash (X) 1 to 1/60 sec. With class "M" bulbs (X) 1 to 1/15 sec. With class "F" bulbs (X) 1 to 1/15 sec. With focal plane bulbs (FP) 1/60 to 1/1000 sec.
Hot Shoe Socket:	Built-in. Easy to attach Accessory Shoe 1 available.
Film Advance: (Manual)	Ratchet type film advance. May be advanced in one stroke or several short strokes for a total of 150° rotation, pre-advance angle 30°. Built-in prevention against double advance with double exposure override capability.
(Motor Drive)	With Motor Drive 1 unit attached, single-frame and continuous advance at speed of 5 frames per second (at exposures above 1/500 sec., with fresh batteries and at normal temperature and humidity).
Exposure Counter:	Progressive type from "S" (Start) to 36 and "E" (End). Counter automatically resets to "S" when camera back is opened.
Film Rewinding:	Rewind crank with automatic-resetting rewind release lever.
Camera Back:	Removable hinge type. Interchangeable with Recordata Back 1 and 250 Film Back 1.
Dimensions & Weights:	With F1.8 lens: 136mm x 83mm x 81mm (5-3/8" x 3-1/4" x 3-3/16") : 680 gr. (24.0 oz.) With F1.4 lens: 136mm x 83mm x 89mm (5-3/8" x 3-1/4" x 3-1/2") : 740 gr. (26.1 oz.) With F1.2 lens: 136mm x 83mm x 97mm (5-3/8" x 3-1/4" x 3-13/16") : 820 gr. (28.9 oz.) Body only: 136mm x 83mm x 50mm (5-3/8" x 3-1/4" x 2") : 510 gr. (18.0 oz.)

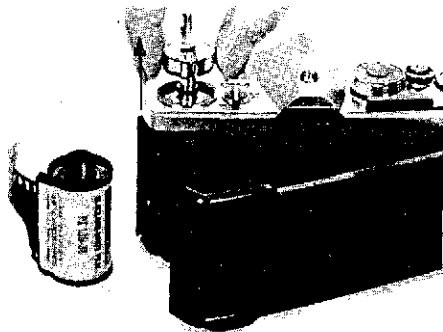

- 1** Load the camera (see page 7). Make sure the battery has been properly inserted and that the camera back is closed tightly.

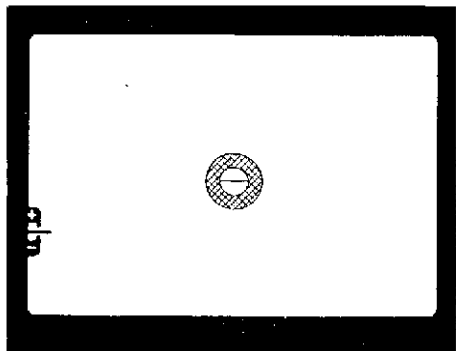

- 4** Look through the viewfinder. Compose and focus. Set the proper exposure (see pages 13, 14, 15).

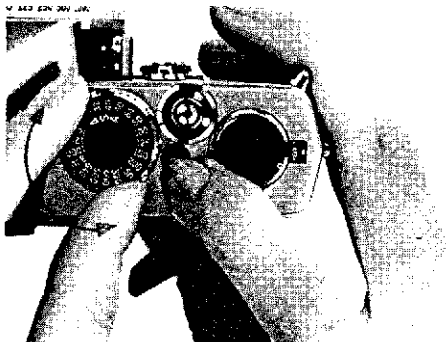

- 2** Set ASA Film Speed (see page 12).

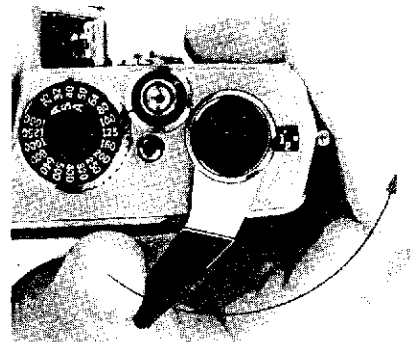

- 3** Advance the film until the figure "1" appears in the exposure counter window (see page 9).



- 5** Take the picture (see page 19). Hold the camera steady and release the shutter with a slow, steady pressure.

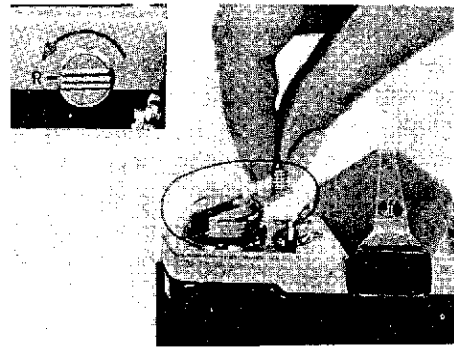

- 6** After the entire film has been exposed, rewind the film back into the cartridge (see page 10).

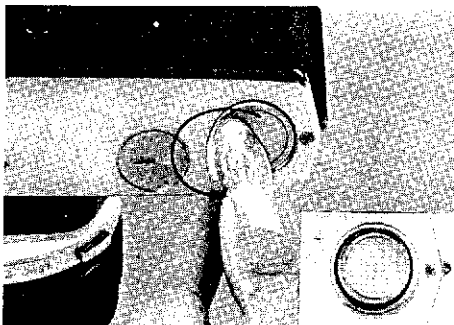

The OLYMPUS OM-1 is supplied with a 1.35V mercury battery (JIS H-D type) to power its through-the-lens exposure metering system. It will last approximately one year depending upon use and must be replaced with an Eveready (UCAR) EPX625, Mallory PX625 or equivalent. Substitutes must not be used. (NOTE; The exposure meter stops functioning when the battery runs out. To prolong battery life, make sure the Meter Switch Lever is in the "OFF" position when the camera is not in use.) To insert the battery:

1) Insert the edge of a coin into the cap of the battery chamber and turn counter-clockwise until the cap has been removed. ↗

↗ 2) Place the battery in the battery chamber making sure the positive side (+) is facing out. The exposure meter does not function if the battery is inserted incorrectly.

3) Replace the cap tightly.

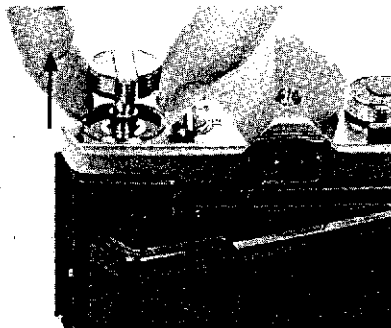

1. Open the camera back.

Pull up on the rewind knob. A slight resistance may be felt before the camera back snaps partially open.

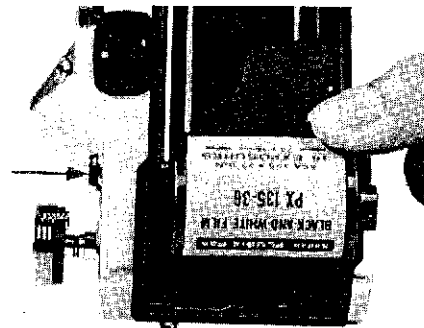

2. Load the camera.

Insert a film cartridge in the film chamber and push the rewind knob back into its original position. It may be necessary to turn the rewind knob slightly before it will lock securely in place.

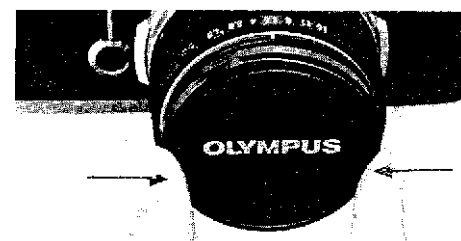

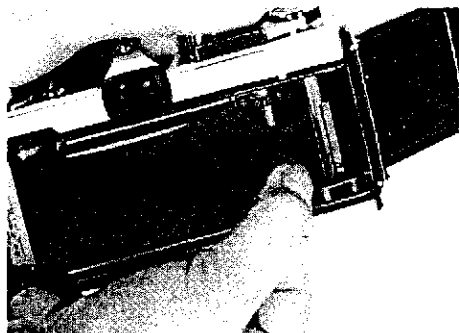

3. Attach the film end to the take-up spool.

Draw out the film leader and insert it into one of the slots in the film take-up spool. Make sure the film is evenly placed between the film guide pins.

Be careful not to permit the film leader to protrude out of the opposite slot when inserted into the spool.

To attach or remove the front lens cap, press the spring-loaded lens cap retaining clips on either side of the cap. The cap then fits easily over the accessory thread of the lens.

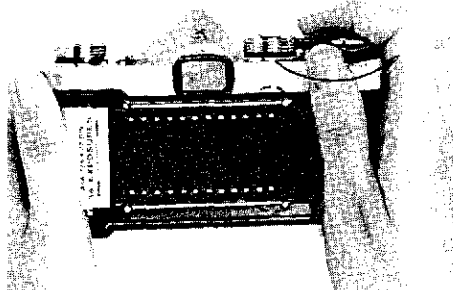

4. Advance the film.

Advance the film using the film advance lever. Make sure that the film perforations engage on the sprockets on both sides.

5. Close the camera back.

Close the camera back until it clicks into place.

6. Tighten the film.

After closing the cover, fold out the rewind crank and turn it slowly in a clockwise direction until a slight resistance is felt. This will take up any slack in the film.

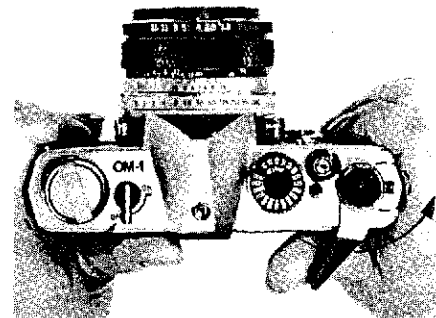

7. Check the exposure counter window.

Advance the film and depress the shutter release button. Advance the film once more until "1" appears in the exposure counter window. The rewind knob will rotate in a counter-clockwise direction indicating that the film is advancing properly.

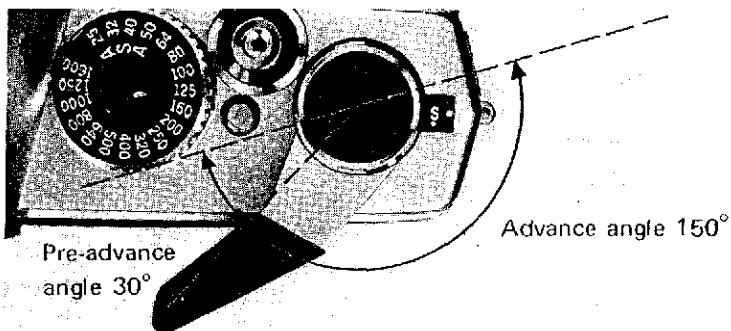

In one stroke the film advance lever:

- 1) advances the film one full frame,
- 2) advances the exposure counter, 3) cocks the shutter, 4) sets the instant return mirror, 5) activates the automatic diaphragm mechanism and 6) activates double advance and double exposure prevention mechanism.

To advance the film:

- 1) Gently pull the film advance lever away from the camera body.
- 2) Advance the lever to the right as far as it will go. **This can be accomplished in a single stroke or in multiple short strokes.**

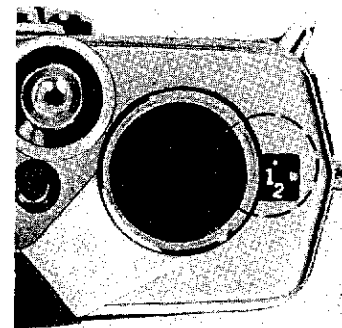

The exposure counter is designed to indicate the total number of frames exposed on the film. Each time the film is advanced by the film advance lever, the exposure counter automatically adds one frame to the total. The counter is indexed in even numbers up to 36 plus "S" (start) and "E" (end). For easy reference, "S", "E", and numbers 12, 20 and 36 are indicated in gold.

Whenever the camera back is opened, the exposure counter automatically returns to "S".

Refer to page 21 for Motor Drive Photography.

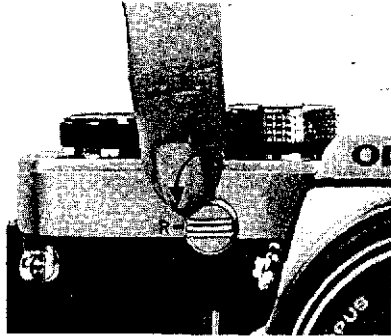

When the entire roll of film has been exposed (indicated by numbers 12, 20 or 36 on the exposure counter depending on film length), rewind the film.

1) Turn the rewind release lever counter-clockwise until the red line is opposite the "R".

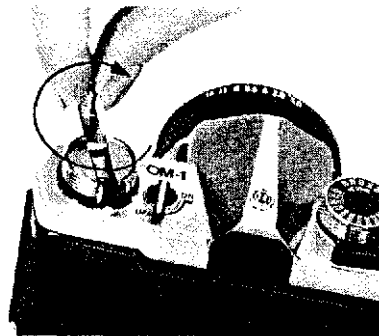

2) Fold out the rewind crank and wind it in the direction of the arrow. During the rewind procedure you will feel tension on the crank. When it turns free the film has been completely rewound back into the cartridge.

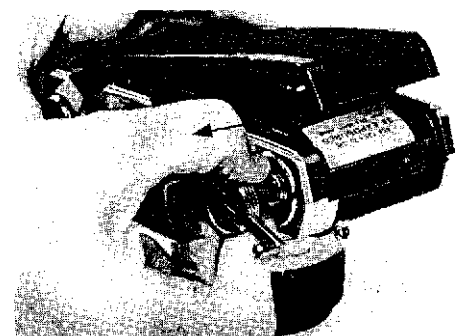

3) Open the camera back by pulling up on the rewind crank and remove the film cartridge. Keep camera and film out of direct sunlight.

IMPORTANT: Do not force the film advance lever if the film has been fully exposed. If there is some resistance, rewind the film to prevent tearing.

■ MAKING DOUBLE EXPOSURES

Should you wish to make more than one exposure on the same frame:

1) After taking the first exposure, turn the rewind knob slowly in a clockwise direction until it stops to take off any slack in the film.

2) Turn the rewind release lever counter-clockwise until the red line is opposite the "R".

3) Hold both the rewind knob and rewind release lever firmly to prevent them from turning and advance the film advance lever. The shutter will then be cocked for the next exposure of the frame, without the film being advanced.

4) Depress the shutter release button with a slow, steady pressure.

5) After completing the multiple ex-

posure, **cover the lens with a lens cap, advance the film and shoot a blank frame** to avoid overlapping.

You can make as many multiple exposures as you like by repeating the above procedure. With each exposure on the same frame (the exposure counter adds one), the likelihood of slippage is increased. Practice is required in order to obtain good results.



SETTING THE SHUTTER SPEED RING

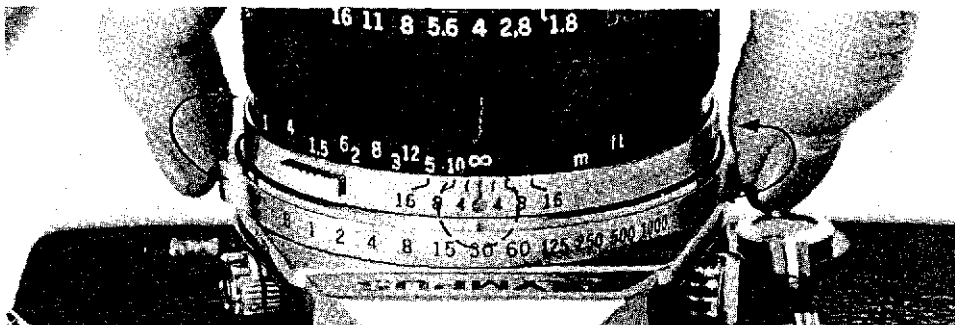

The length of time that light is allowed to strike the film is controlled by the focal plane shutter. The shutter consists of two opaque "curtains" which travel across the opening and allow light to reach the film. The speed and coordinated movement of these curtains determine in fractions of a second the exposure time for your picture. For example, 1000 on the shutter speed ring indicates 1/1000 of a second and 60 indicates 1/60 of a second. The figure 1 indicates one full second. The B (Bulb) setting is used for longer time exposures. At this setting the shutter will remain open as long as the shutter release button is held down. For exposures less than 1/30 of a second, it is advisable to use a cable release, tripod or other steadying devices to avoid

camera movement which can result in blurred or fuzzy pictures.

To set the shutter speed turn the shutter speed ring in either direction until the desired number clicks into place opposite the reference dot on the lens barrel. **Set the ring only at click-stop positions as no in-between settings can be used.** Shutter speeds may be set before or after advancing the film.

NOTE: Speeds from "B" to "60" are indicated on the ring in blue as an easy reference to "X" flash synchronization.



SETTING THE APERTURE RING



The amount of light allowed to strike the film is represented by "F" numbers or "F" stops engraved on the aperture ring. The higher the F number, the smaller the lens opening (less light); the lower the number, the larger the lens opening (more light). When setting the aperture ring you can use either the click-stop positions or any in-between settings to obtain precise exposure.

All lenses in the OLYMPUS OM SYSTEM (other than specialized lenses) provide fully automatic diaphragm control allowing you to focus and compose your picture with the lens at maximum aperture or "wide open." The diaphragm will automatically stop down to the preselected F stop at the moment of exposure and immediately re-open when exposure is completed.

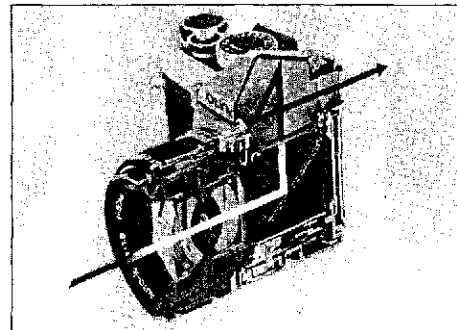
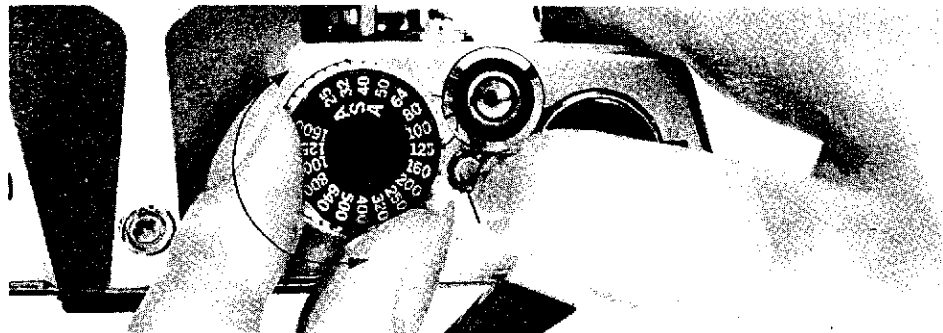

Setting the correct ASA film speed on the camera is one of the most important factors in determining exposure. In order to obtain properly exposed pictures, the correct ASA film speed must be set on the ASA film speed dial. To set the dial:

- 1) Pull the film advance lever slightly away from the camera body.
- 2) Press the film speed dial release button and turn the film speed dial until the ASA rating for the film being used is opposite the black line engraved on the outer ring of the shutter release button.
- 3) Release the button making sure that **the dial is securely in place and does not move.**

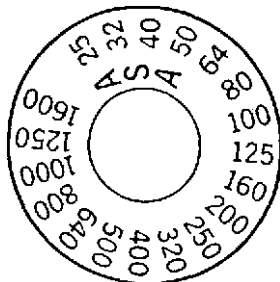

The OLYMPUS OM-1 incorporates a built-in, wide-open exposure metering system which uses two highly sensitive CdS cells with one positioned on each side of the eyepiece. These cells measure the actual amount of light entering the lens, placing the greatest emphasis at the center of the picture area. Measurements are taken with the lens diaphragm at maximum aperture (wide open) allowing you to take full advantage of a brighter viewfinder when focusing and composing your picture. The OM-1 metering system operates as above with all OM System camera lenses (except a few special lenses) regardless of the focal length, filters, etc.

OLYMPUS OM-1 SETTING THE EXPOSURE

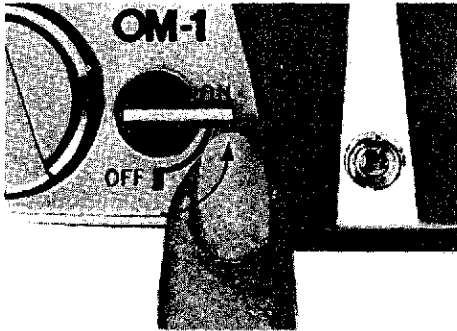

■ Activating the Meter

The OLYMPUS OM-1 metering system is directly coupled to the shutter speed ring, aperture ring and ASA film speed dial.

To activate the meter, move the meter switch lever at the top of the camera to the "ON" position. To prolong battery life, it's a good idea to return the lever to the "OFF" position when the camera is not in use.

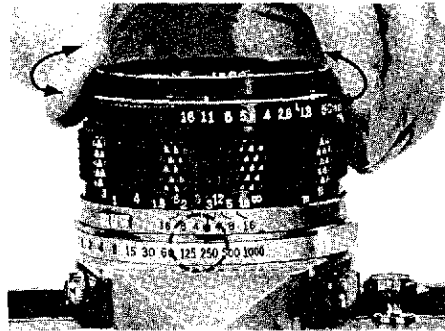

■ Preselecting the Shutter Speed

Should you wish to select a shutter speed to meet a specific photographic situation (for example, to stop fast action, eliminate camera shake, etc.):

- 1) Turn the shutter speed ring until the desired speed is opposite the red reference dot on the camera lens.
- 2) Look through the viewfinder and turn the aperture ring until the needle lines up in the center of the index. For fine exposure adjustment you can use any intermediate F stop position on the aperture ring.
- 3) If the needle will not align properly, select a new shutter speed. To correct over-exposure (+), try a faster speed; to correct under-exposure (-), try a slower speed.

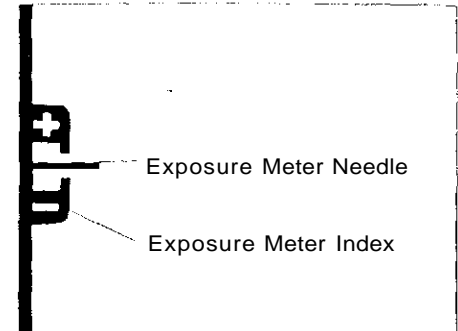

■ Preselecting the F Stop

Should you wish to preselect the F stop (for example, to control depth of field for greater creative impact):

- 1) Turn the aperture ring until the desired F stop is opposite the white index mark at the front of the lens barrel.
- 2) Look through the viewfinder and rotate the shutter speed ring until the needle lines up as close as possible to the center of the index. Make sure that shutter speed meets the other requirements of the situation.
- 3) Make the final exposure adjustment by turning the aperture ring slightly until the needle aligns exactly in the center of the index.

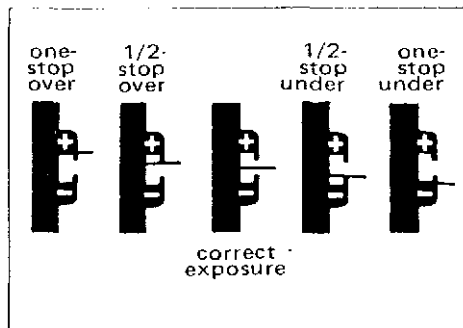

■ Making Intentional Over- or Under-exposures

You can make intentional over- or under-exposures to meet special lighting requirements (such as backlighting, sidelighting, etc.) by using the central index in the viewfinder as a guide. When the needle swings towards the (+) position, it indicates over-exposure. When it swings towards (-), it indicates under-exposure. The exact F stop-needle relationship is shown in the above diagrams.

■ Caution in Low-light Exposure Metering

The meter's exposure range is EV2—17 (ASA 100 with F1.4.) The combinations listed below indicate the lowest measurable limit in dealing with dark subjects.

Below this limit or with the meter switch at OFF, when the aperture ring or shutter speed ring is rotated, the needle might sometimes swing but the meter will not work.

Lens	F/Stop	Shutter Speed
50mm F1.8	Fully open	1/2 sec
50mm F1.4	Fully open	1/2 sec
55mm F1.2	Fully open	1/2 sec

■ Stop-down Exposure Readings

When using the OM-1 in conjunction with the extension tubes, bellows or the Zuiko Shift Lens it is necessary to take meter readings with the lens stopped down. After setting the desired aperture on the aperture ring, stop the lens diaphragm down and look through the viewfinder. Rotate the shutter speed ring until the needle aligns within the center of the index. (See the instructions on Preselecting the F Stop, page 13.)

■ Special Exposure Techniques

1) Backlighting and Sidelighting

When the most important area of the picture is much darker than the general picture area (strong light hitting the main subject from behind or from the side) the meter will have a tendency to

read the brightest part of the picture leaving the main subject under-exposed. To compensate for this, move in towards the subject until most of the subject image appears in the viewfinder and take your meter reading. After setting the exposure, return to your original position to take the picture. If this procedure cannot be followed, you can obtain approximately the same results by simply opening your lens one full F stop over the indicated meter reading. (NOTE: With backlighting or sidelighting, it's always a good idea to use a lens hood to eliminate unwanted glare.)

2) Strong Frontlighting and Deep Shadows

When taking a picture of a bright subject against a dark background (spotlights, deep shadow areas, etc.) the meter has a tendency to read the darkest part of the picture leaving the main subject over-exposed. To compensate for this use the same procedure for setting exposure as outlined for backlighting. You can also approximate the proper exposure by holding your position and closing the lens down one full F stop from the indicated meter reading.

OLYMPUS OM-1 FOCUSING



The OLYMPUS OM-1 comes equipped with the standard Focusing Screen 1-13 (microprism/split image-matte type) which is designed to make focusing quick and easy. To focus, look through the camera viewfinder and turn the focusing ring in either direction until split vertical lines of the subject image in the rangefinder are aligned or the "shimmering effect" of the microprisms disappears. If you are focusing on the matte area, the subject is in focus when the image is sharp.

* You can determine the distance between the subject and the film plane by reading the distance scale on the focusing ring after you achieve critical focusing. The actual distance is indicated opposite the red central index mark on the lens mount ring; the white scale indicates this distance in meters

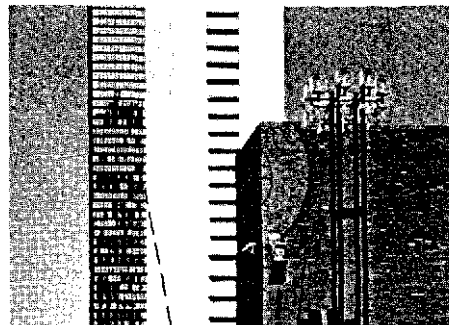

▲ In focus



▲ Out of focus

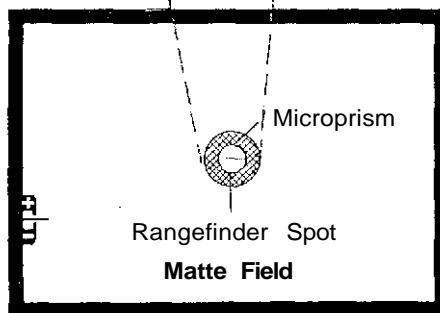

The OM-1 viewfinder takes in 97% of the actual picture area for added convenience when composing your pictures.

and the orange scale indicates this distance in feet.

CHANGING THE LENS

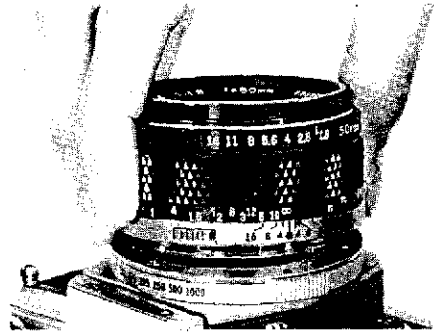
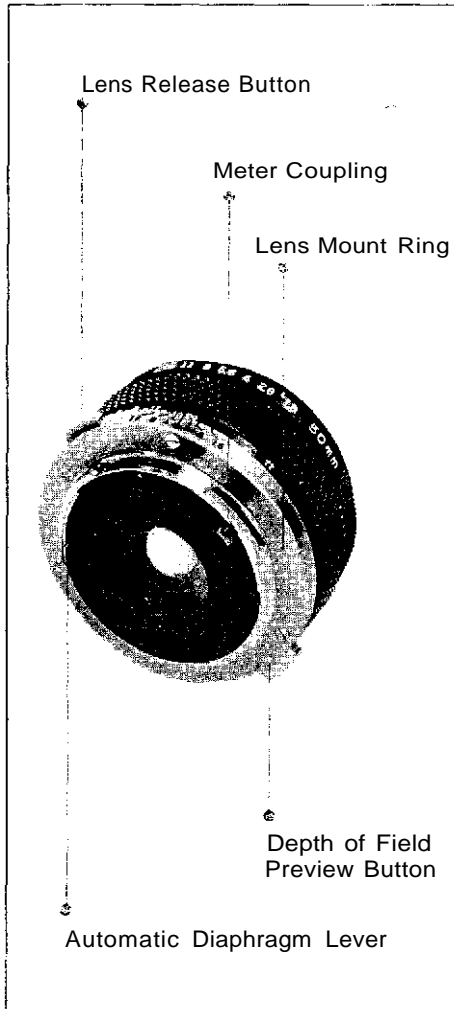

To mount the lens, grasp the lens firmly and align the red dots on the lens flange and the camera mount ring. Turn the lens clockwise until it locks in place. The lens release button will spring up and you will hear a positive "click" when the lens has been fully engaged. **Do not apply pressure to the lens release button during the mounting procedure.** This will assure proper coupling between the lens and the meter.



The bayonet mount of the OLYMPUS OM-1 allows you to change lenses quickly and easily.

To detach the lens, press down on the lens release button and turn the lens counter-clockwise. Grasp the lens firmly and remove it from the camera body.

Protect your lens and camera! Always attach the front and rear lens caps when the lens is removed from the camera to prevent any possibility of damage. Never leave the camera body in direct sunlight with the lens removed and, if you plan to store the camera without the lens, the use of a body cap is recommended.

INFRARED PHOTOGRAPHY/DEPTH OF FIELD SCALE/PREVIEW BUTTON

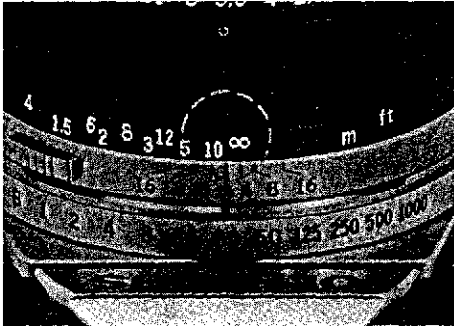

The OM System lenses are provided with an infrared index mark engraved in red on the depth of field scale to the right of the reference dot. When shooting with infrared film, focus normally on your subject without the red filter on and read the subject distance on the distance scale. Then, turn the focusing ring to the right until the distance reading is opposite the infrared index mark. Your lens will then be in focus for average infrared photography. Shoot with the red filter on. In the above picture the red index is set at infinity.

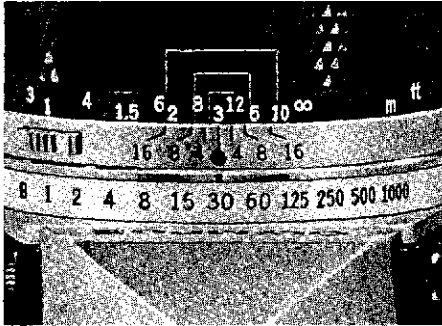

The double series of numbers engraved on the depth of field scale represents F stops: F4, F8 and F16. Once you have focused on your subject, all objects within the distance range indicated on the lens distance scale between the marks for the F stop you have selected will have acceptable sharpness.

For example, in the above picture the camera-to-subject distance is 3m (10ft) and the lens is set at F16. If you read the distance scale at the points opposite the engraved "16" on both sides of the reference dot, you will find that the depth of field is from 1.9m (6ft) to 7m (23ft). The depth of field can be visually verified by pressing the depth of field preview button.

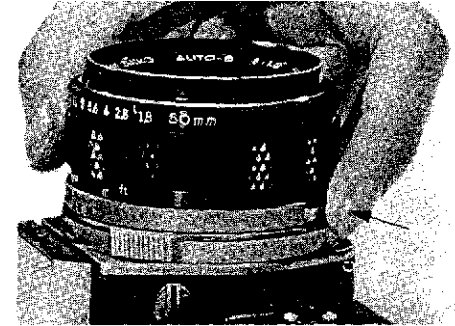

When you wish to see which objects fall within the acceptable zone of sharpness (depth of field), press the preview button on your lens. The diaphragm of the lens will stop down to the preset F stop enabling you to see the depth of field in the camera viewfinder.

* If you jerk the preview button while depressing the shutter button halfway down, the shutter might get released. Gently push and release the preview button to avoid accidentally releasing the shutter.



DEPTH OF FIELD

Depth of field is the area of acceptable sharpness in front of and behind the subject in focus. This depth is determined by the F stop you have selected and the distance from the subject in focus to the film plane. As you get closer to your subject or as you open your lens (e.g. from F22 to F2.8) the depth of field becomes shallower. By stopping your lens down (e.g. from F2.8 to F22) or getting farther away from your subject this depth of field or zone of acceptable sharpness can be increased.

Another factor in determining depth of field is the focal length of your lens. As a rule the shorter the focal length, the greater the zone of acceptable sharpness. The longer the focal length, the shallower this zone becomes.

The table above shows that when the camera-to-subject distance is 3m (10ft), the depth of field at F16 ranges from 1.93m (6ft) to 6.93m (23ft).



F1.8 (1/1000sec.) F16 (1/30sec.)

Depth of Field Table (F1.8 & F1.4 Standard Lenses) Circle of least confusion 1/30 mm

Scale F Stop	Camera-to-Subject Distance (m) Figures with * are engraved on the distance scale.									
	*0.45	*0.5	*0.7	*1	*1.5	*2	*3	*5	*10	*∞
1.4	0.45 ~0.45	0.50 ~0.50	0.69 ~0.71	0.99 ~1.02	1.47 ~1.54	1.94 ~2.07	2.86 ~3.16	4.61 ~5.46	8.55 ~12.05	57.78 ~∞
1.8	0.45 ~0.45	0.50 ~0.50	0.69 ~0.71	0.98 ~1.02	1.46 ~1.55	1.92 ~2.09	2.82 ~3.20	4.52 ~5.60	8.21 ~12.79	45.05 ~∞
2	0.45 ~0.45	0.50 ~0.50	0.69 ~0.71	0.98 ~1.02	1.45 ~1.55	1.91 ~2.10	2.80 ~3.23	4.47 ~5.68	8.05 ~13.20	40.57 ~∞
2.8	0.45 ~0.45	0.49 ~0.51	0.69 ~0.71	0.97 ~1.03	1.43 ~1.57	1.88 ~2.14	2.73 ~3.33	4.28 ~6.01	7.47 ~15.15	29.02 ~∞
4	0.44 ~0.46	0.49 ~0.51	0.68 ~0.72	0.96 ~1.04	1.41 ~1.61	1.83 ~2.20	2.63 ~3.49	4.04 ~6.57	6.74 ~19.44	20.35 ~∞
5.6	0.44 ~0.46	0.49 ~0.51	0.67 ~0.73	0.94 ~1.06	1.37 ~1.66	1.77 ~2.29	2.51 ~3.74	3.75 ~7.52	5.96 ~13.31	14.55 ~∞
8	0.44 ~0.46	0.48 ~0.52	0.66 ~0.74	0.92 ~1.09	1.32 ~1.73	1.69 ~2.45	2.34 ~4.18	3.39 ~9.61	5.09 ~378.10	10.21 ~∞
11	0.43 ~0.47	0.48 ~0.53	0.65 ~0.76	0.90 ~1.13	1.27 ~1.84	1.60 ~2.68	2.17 ~4.91	3.02 ~14.74	4.30 ~∞	7.44 ~∞
16	0.43 ~0.48	0.47 ~0.54	0.63 ~0.79	0.86 ~1.20	1.19 ~2.05	1.47 ~3.17	1.93 ~6.93	2.57 ~138.43	3.42 ~∞	5.13 ~∞

Scale F Stop	Camera-to-Subject Distance (ft) Figures with * are engraved on the distance scale.							
	*2	*3	*4	*6	*8	*12	30	*∞
1.4	1.98 ~2.02	2.96 ~3.04	3.93 ~4.08	5.83 ~6.18	7.69 ~8.33	11.31 ~12.78	25.97 ~35.51	187.12 ~∞
1.8	1.98 ~2.02	2.95 ~3.05	3.91 ~4.10	5.78 ~6.23	7.61 ~8.43	11.13 ~13.01	25.02 ~37.47	146.31 ~∞
2	1.98 ~2.02	2.94 ~3.06	3.90 ~4.11	5.76 ~6.26	7.57 ~8.48	11.05 ~13.14	24.57 ~38.54	131.88 ~∞
2.8	1.97 ~2.03	2.92 ~3.08	3.86 ~4.15	5.67 ~6.37	7.41 ~8.69	10.71 ~13.66	22.91 ~43.50	94.60 ~∞
4	1.96 ~2.05	2.89 ~3.12	3.80 ~4.22	5.54 ~6.54	7.19 ~9.02	10.23 ~14.51	20.81 ~53.91	66.45 ~∞
5.6	1.94 ~2.07	2.85 ~3.17	3.72 ~4.32	5.38 ~6.79	6.91 ~9.51	9.67 ~15.85	18.54 ~79.26	47.60 ~∞
8	1.91 ~2.10	2.79 ~3.25	3.62 ~4.48	5.15 ~7.20	6.53 ~10.35	8.93 ~18.38	15.95 ~270.28	33.41 ~∞
11	1.88 ~2.13	2.72 ~3.35	3.49 ~4.69	4.89 ~7.79	6.11 ~11.64	8.15 ~23.00	13.58 ~∞	23.36 ~∞
16	1.83 ~2.20	2.61 ~3.51	3.31 ~5.09	4.52 ~9.02	5.53 ~14.70	7.12 ~39.68	10.89 ~∞	16.80 ~∞



HOLDING THE CAMERA



Proper camera handling is important in assuring the sharpest possible pictures.

Holding the Camera Horizontally

Keep both elbows close to the body, to steady the camera.

Putting the Camera into Operation

The aperture ring, focusing ring and shutter speed ring are so arranged as to enable one hand operation right up to the moment the shutter is released. Hold your breath at the moment of shutter release. Transport the film advance lever with your right thumb and squeeze the release button smoothly using the cushion, not the tip, of your index finger.



Holding the Camera Vertically

For vertical shooting, keep one elbow close to your body and press the camera tightly against your forehead.

NOTE: Steady yourself against any nearby support (such as a tree, fence, or wall) whenever possible.

NOTE: For telephotography, or slow shutter speed photography, it is recommended that you use a tripod and hold the camera steady with your hands.



INTERCHANGEABLE FOCUSING SCREENS

(Handle with extreme care.)

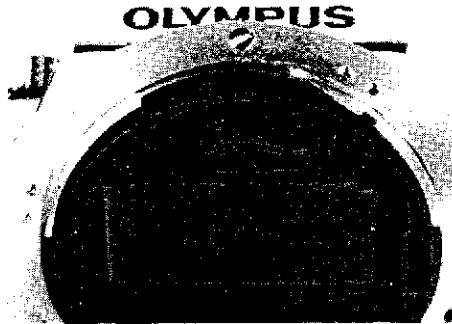

The OM System interchangeable focusing screens provide you with the ultimate in focusing versatility. Optional screens are available to suit virtually every picture-taking situation. The focusing screens come with a special tool. To remove the focusing screen:

- Detach the camera lens from the camera body (see p. 16).
- Use the special tool provided to push up on the release catch underneath the top ledge of the mirror box (see the photo above). This allows the screen and screen frame to drop down.
- Remove the screen from inside the camera by gripping the tip of the screen with the tool as shown.
- To install the screen, fit it in the

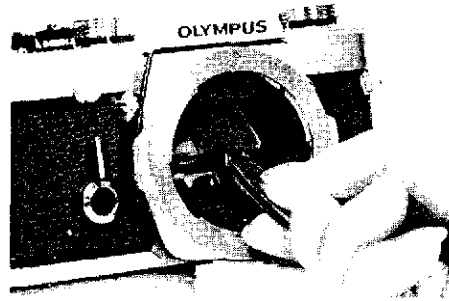

frame and push the frame upward gently until it clicks into place. Gently shake the camera body to make sure the screen is held securely in place.

IMPORTANT: Although the above procedure could be done with fingers, it is recommended that you use the special tool supplied. **Changing focusing screens is a procedure to be handled with great care.** Trying to change screen with your fingers can result in fingerprints and costly damage to the surface of the screen, the prism, or the mirror. Should this occur, cleaning or repair **MUST** be handled by an authorized service center. Such damage is not covered by the product warranty.



List of Optional Focusing Screens

1-1 Microprism-matte type (for most lenses)	1-8 All matte type (for telephoto lenses and astronomical telescopes)
1-2 Microprism-matte type (for standard and telephoto lenses)	1-9 Clear field type (for endoscopic photography)
1-3 Split image matte type (for most lenses)	1-10 Checker-matte type (for Split lens)
1-4 All matte type (for most lenses)	1-11 Cross hairs-matte type (for close up and macrophotography)
1-5 Microprism-clear field type (for wide angle and standard lenses)	1-12 Cross hairs clear field type (for photomicro and macrophotography)
1-6 Microprism-clear field type (for standard and telephoto lenses)	1-13 Microprism/split image-matte type (for most lenses)
1-7 Microprism-clear field type (for super telephoto lenses)	* See page 44 for details. (Specifications subject to change without notice.)



MOTOR DRIVE PHOTOGRAPHY

Motor Drive has many exciting recreational, professional and scientific applications including sports photography, action portraits, copying literature, wildlife photography and time-lapse photography.

By automatically advancing the film and cocking the shutter, the motor drive not only frees the photographer from the burden of manually advancing the film, but also allows him to shoot a series of pictures that might otherwise be lost through the time-consuming manual method.

The Motor Drive package is specifically

tailored to the compact size of the Olympus OM-1. Extremely small and lightweight, the Motor Drive 1 mounts directly to the camera base creating one of the most compact and maneuverable motor drive systems available. Although reduced in size and weight, the OM System Motor Drive Group excels in performance. The basic Motor Drive package can provide operation up to 5 frames per second in optimum conditions*, has single release capability and offers motor drive sequence applications over a wide range of shutter speeds.

The following instructions (pp. 23-25) are for the basic motor drive system consisting of the Olympus OM-1, Motor Drive 1, and M.18V Control Grip 1 or M.15V Ni-Cd Control Pack 1.

*Optimum conditions: Maximum framing rate varies with temperatures, types of films and batteries, etc. The word optimum implies such conditions in which sequence filming is made at normal temperatures at shutter speeds of 1/500 of a second and faster, using the M. 18V Control Grip 1 containing fresh superpower manganese batteries. Cartridges with smooth film moving must also be used.

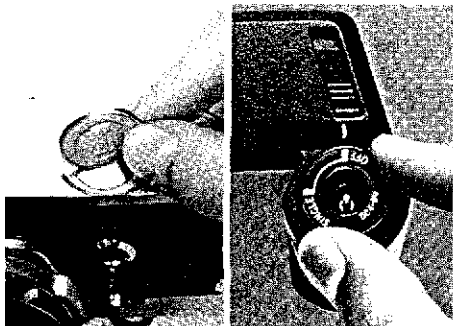

■ Attaching the Winder 1

[1] Remove the motor drive socket cap. Remove the motor drive socket cap from the camera base plate by rotating it counter-clockwise with a coin until the index dot on the cap is aligned with the index dot on the camera.

To replace the cap, align the index dot on the cap with the index dot on the camera, and turn the cap clockwise with a coin until the index dot on the camera is aligned with the groove on the cap.

(The removed motor drive cap can be stored in the socket cap storage positioned on the underside of the battery holder compartment.)

[2] Pull up and rotate the switch dial to the "OFF" position.



③ Attach the Winder 1

[1] Remove the M.6V Battery Holder 1 from inside the winder, insert four 1.5 V penlight (AA) size batteries into the battery holder, and put it back into the compartment.

[2] Insert the motor drive guide pin into the guide pin hole on the camera base plate. To assure proper connection, adjust the position of the Winder 1 until it is flush with the camera. Turn the clamping screw clockwise until the Winder 1 is securely attached to the camera base plate.

The Winder 1, designed primarily for single-frame shooting, operates on four self-contained AA batteries and is extremely compact and light. The unit advances the film and cocks the

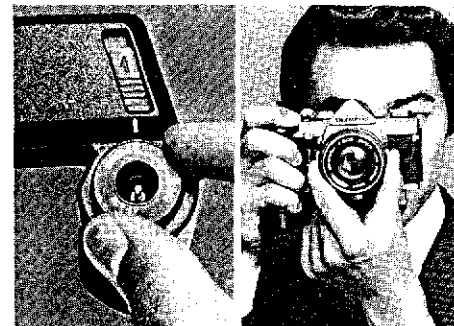

■ Taking the pictures

[1] Pull up and rotate the switch dial to the "SINGLE" position.

[2] Press the shutter release.

shutter as soon as exposure is made (wind-on time—0.3 sec.), so that the photographer can always be ready to freeze the subject at the right moments.



OPERATION OF BASIC MOTOR DRIVE PACKAGE

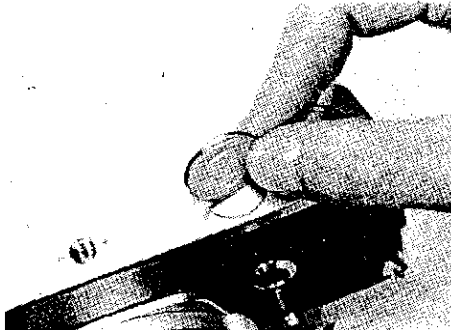

■ Attaching the Motor Drive 1

- 1 Remove the motor drive socket cap. (See page 22, left column.)

■ IMPORTANT:

- * Always store the socket cap in the same place to avoid loss.
- * After removing the motor drive from the camera, be sure to replace the socket cap to keep the camera free of dust and

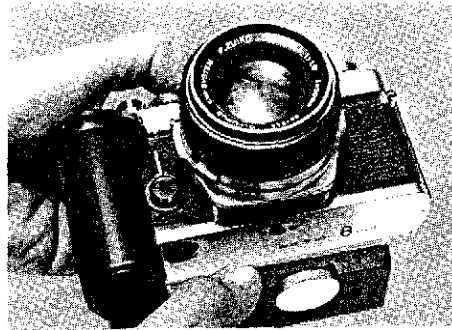

- 2 Attach the Motor Drive 1 in the same manner as with the Winder 1. (See page 22, middle column.)

dirt, and to prevent the possibility of stray light entering the socket and fogging the film.

- * Do not remove the socket cap when you do not use the motor drive.



■ Attaching the M. 18V Control Grip

- 1 Remove the M. 18V Battery Holder 1, insert twelve 1.5V penlight (AA) size batteries into the battery holder, and re-insert the battery holder into the Control Grip.
- 2 Align the red index line on the rear of the control grip with the red index line on the rear frame of the motor drive unit until the mounting catch is engaged.
- 3 Carefully push the control grip forward until it snaps into the front of the motor drive.

*Voltage Requirement: DC 18V with "AA" (penlight) size batteries, or DC 12V—16V with external power sources of large potentiality in conjunction with relay cords.

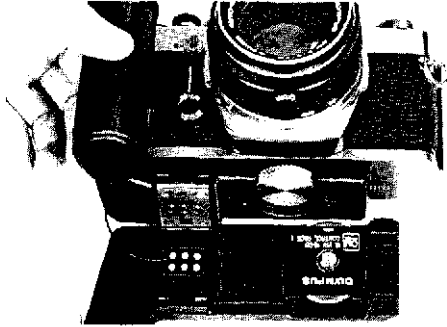

■ Attaching the M. 15V Ni-Cd Control Pack 1

Prior to use, the Control Pack should be checked to insure that it has been adequately charged. If its charge is inadequate, use the M. 15V Ni-Cd Charger.

Aligning the red index lines of the Motor Drive 1 and the Control Pack, engage the mount catch. Then push the Control Pack forward and upward until it snaps on the motor drive, then clamp securely.

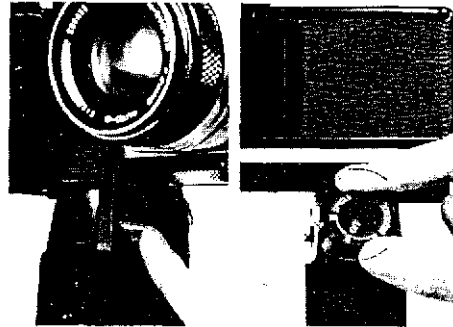

■ Photography with the Motor Drive Units

Using the M. 18V Control Grip 1

① Unlock the shutter release lock lever on the Control Grip by moving it forward and upward.

* The lever is provided to lock the shutter release on the Control Grip for safety sake in general or when a relay cord is used.

② Turn the mode selector on the Control Grip to either "SINGLE" or "SEQUENCE". Set the mode selector to the "OFF" position when the Motor Drive 1 is not in use.

* At "SINGLE", exposure is possible at all shutter speeds from 1 sec. to 1/1000 sec.

At "SEQUENCE", exposure is possible at all shutter speeds except B. and 1 sec.

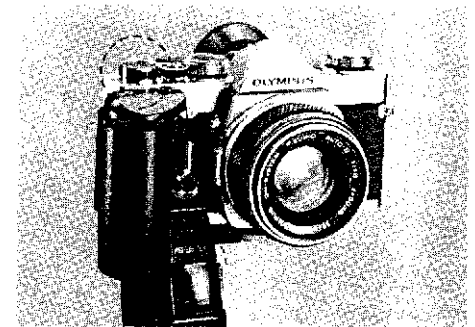

③ You may use either the shutter release on the Control Grip 1 or the shutter release on the Motor Drive 1 to trigger the shutter. It is generally more convenient to use the shutter release on the Control Grip when the camera is held in the horizontal position and the shutter release on the Motor Drive 1 when the camera is held in the vertical position.

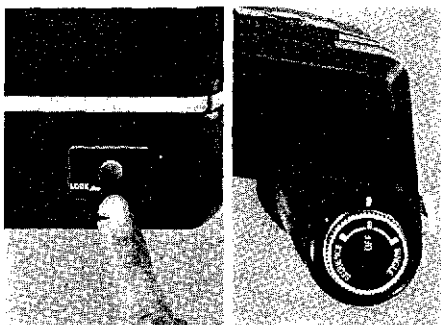

Using the M. 15V Ni-Cd Control Pack 1

① Slide the shutter release lock button on the Control Pack to the unlock position.

* The button is provided to lock the shutter release on the Control Pack for safety sake in general or when a relay cord is used, etc.

② Pull and turn the mode selector until it clicks to either "SINGLE" or "SEQUENCE".

In either mode, available shutter speeds are the same as those with the Control Grip. (See page 24, middle column.)

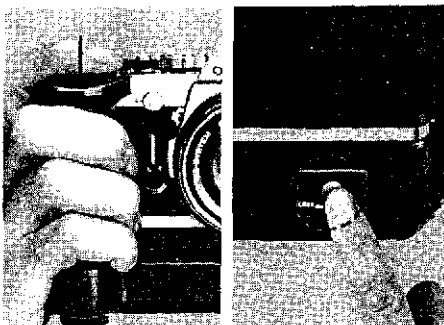

③ You may use either the shutter release on the Control Pack 1 or the shutter release on the Motor Drive 1 to trigger the shutter. It is generally convenient to use the shutter release on the Motor Drive 1 and the shutter release on the Control Pack 1 for use with the 250 Film Back 1.



■ Loading the Film

Always try to load your camera after the motor drive has been attached. This eliminates even the remotest possibility of light leak through the motor drive socket. If this is not possible, attach the Motor Drive unit in a dimly-lit area.



FLASH PHOTOGRAPHY

Electronic flash or bulbs may be used to soften shadows in daylight conditions as well as to provide artificial illumination when available light is inadequate for proper exposure.

Your choice of a flash unit will depend upon your individual photographic needs, and may include the Olympus Quick Auto 310, PS 200 Quick or PS 200.

The Accessory Shoe 1 is screwed into the hot shoe socket on the OM-1 pentaprism housing to provide direct contact with the clip-on type electronic flash.

(For the selection of units, see page 45.)

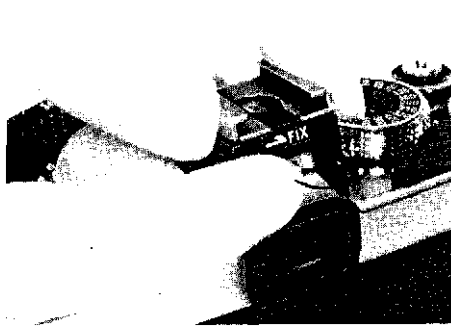

■ Use of Electronic Flash Units

① Attach the Accessory Shoe 1 to the OM-1.

* Detach the accessory shoe when a flash is not mounted on the camera (because the shoe may come in the way during photography), or when a side-mounting bracket is used to support the flash unit (because you may feel a small electrical shock when touching the terminal contact of the accessory shoe).

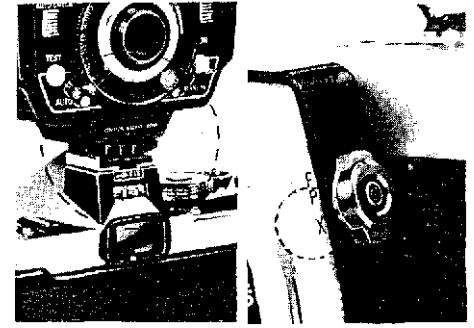

② Mount the flash unit on the camera. Slide the flash unit into the camera's accessory shoe as far as it will go.

* If your electronic flash unit does not have a direct contact "hot shoe", connect its synchro cord to the flash synchro socket on the camera.

③ Set the camera's synchro terminal switch (FP and X flash selector) to "X".

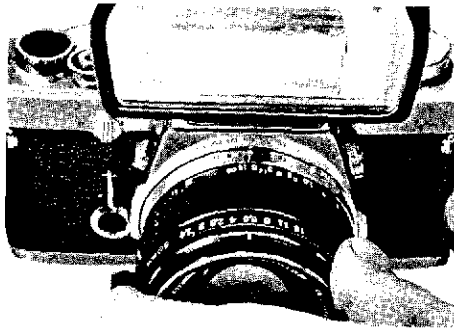

④ Set the shutter speed ring to a shutter speed of 1/60 second or slower (all shutter speeds indicated in blue on the shutter speed ring).

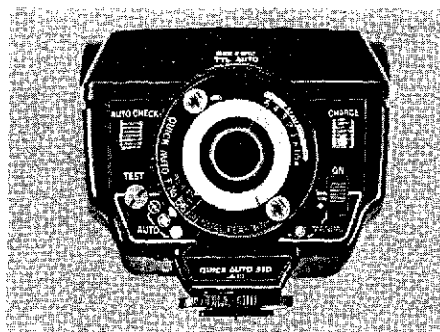

⑤ Set the F stop on the aperture ring.

① Auto Flash Exposure Control
Follow your flash equipment instructions for the selection of F stop for automatic flash exposure control (in case of the Quick Auto 310, one of F4, F5.6, F8; ASA 100).

* The TTL AUTO setting on the Quick Auto 310 is exclusively for use with the OM-2 and cannot be used with the OM-1.

② Manual Flash Exposure Control
Determine the correct F stop for proper flash exposure by using the calculator dial or exposure table provided with your flash equipment. You may also determine the correct F stop by using the following formula:

$$F \text{ stop} = \frac{\text{flash guide number}}{\text{flash-to-subject distance}}$$

■ DAYLIGHT FILL-IN FLASH

[1] Manual Flash Exposure Control

① If your electronic flash unit has manual/auto flash exposure control, set it for manual operation.

② Focus on your subject to determine the camera-to-subject distance.

③ Using the calculator dial, exposure table, or guide number formula, determine the correct F stop for proper flash exposure at the distance you found in Step 2. Set this F stop with the camera aperture ring. In case of the Quick Auto 310, after setting the auto/manual switch dial to the "HI" position, read the F number corresponding with the planned flash-to-subject distance, using the distance scale provided.

④ Turn the shutter speed ring until the meter needle centers between the over- and under-exposure index marks in the camera viewfinder.

⑤ If the shutter speed is 1/60 second or slower, you are ready to take the picture.

If the shutter speed is faster than 1/60 second, the flash will not fire if you attempt to take the picture. Therefore, you must readjust the exposure settings

as follows:

- a. Reset the shutter speed to 1/60 second.
 - b. Turn the aperture ring until the meter needle centers between the over- and under-exposure index marks in the camera viewfinder.
 - c. Using the flash calculator dial, exposure tables, or guide number formula, determine the correct flash-to-subject distance for the F stop now set on the camera's aperture ring,
 - d. Move to this distance from the subject and re-focus *or* remove the flash unit from the camera and move it only to this distance from the subject using a synchro cord extension to maintain flash synchronization with the camera.
- ② Automatic Flash Exposure Control
- ① If your electronic flash unit has manual/auto flash exposure control, set it for auto operation.
 - ② Set the camera's shutter speed ring to 1/60 second.
 - ③ Turn the aperture ring until the meter needle centers between the over- and under-exposure index marks in the camera's viewfinder.
 - ④ Focus on your subject to determine the camera-to-subject distance.
 - ⑤ If your electronic flash unit has an

"AUTO F STOP" that corresponds with the F stop set on your camera and if that "AUTO F STOP" will provide automatic flash control within the distance range you found in Step 5, you may take the picture using this "AUTO F STOP" setting on your electronic flash unit. If these conditions are not met, use the procedures for Manual Flash Exposure Control. (In case of the Quick Auto 310, determine the F number and set the auto/manual switch dial to one of F4, F5.6 or F8; ASA 100).

■ FLASHBULB PHOTOGRAPHY

- ① Mount the Accessory Shoe 1 to the camera and insert the shoe mount of the flash unit into the accessory shoe.
 - * If your flash unit does not have a "hot shoe" contact, plug the flash unit's synchro cord into the synchronizing socket.
- ② Select the proper shutter speed and synchro setting from the table below according to the type of bulb being used and make these settings on the camera.
- ③ Determine the correct F stop for flash exposure by using the guide number formula. (See page 27.)
 - * The guide number for any flashbulb/film combination may be found on the flashbulb packaging.
- ④ Set the correct F stop with the camera's aperture ring.

■ The table indicates proper synchronization speeds for most flash equipment.

Terminal	Flash Lamp	Shutter Speed										
		1000	500	250	125	60	30	15	8	4	2	1
FP	FP	○	○	○	○	○	*	*	*	*	*	*
X	Electronic Flash					○	○	○	○	○	○	○
	MF						*	○	○	○	○	○
	M · FP							○	○	○	○	○

○ = Recommended; * = Not recommended due to bulb quality.

SETTING THE SELF-TIMER

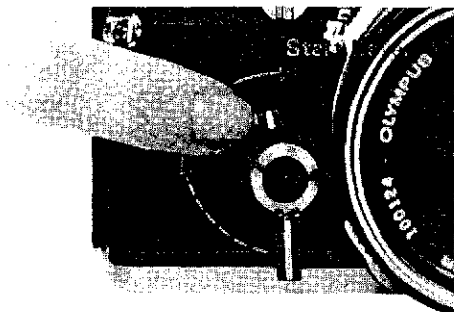

The self-timer provides a method of taking delayed action pictures allowing you to get into your own photographs. It is also ideal for macrophotography when a cable release is not available.

To set the self-timer:

- 1) Rotate the self-timer lever counter-clockwise until it stops (approximately 180°). Make sure the film has been advanced properly.
- 2) Turn the start lever clockwise to the vertical position to activate the self-timer lever. The shutter will then be released in approximately 12 seconds. You can adjust the delay time between four and twelve seconds by adjusting the lever as shown above.

If the film has not been advanced properly, the timer lever will stop halfway and the shutter will not fire. To re-activate the timer, move the start

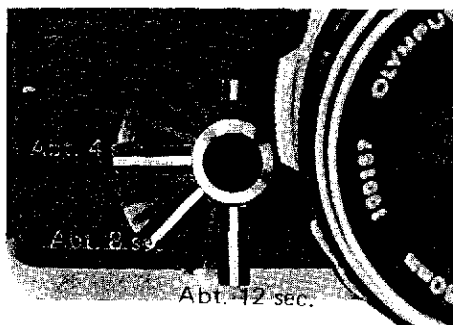

lever counter-clockwise to stop the timer lever, return the timer lever to the starting position, and advance the film. Then, turn the start lever again. NOTE: If you do not reset the self-timer, the timer lever will begin moving immediately after advancing the film and the shutter will be released earlier than expected.

You may set the self-timer lever either before or after advancing the film. Even after setting the lever, you can release the shutter by pressing the shutter release button. To stop the self-timer during its operation, turn the start lever counter-clockwise.

LOCKING UP THE MIRROR

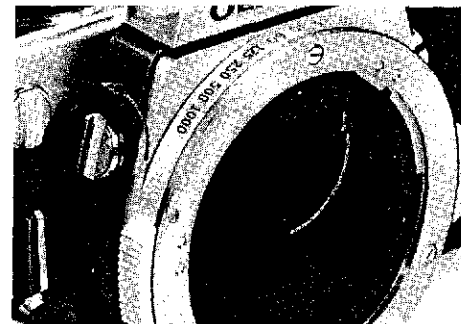

To minimize camera vibration in close-ups, reproduction work, macro-photography and photomicrography, you can lock the instant return mirror in the up position to eliminate mirror shock. This is also handy in rapid sequence shooting. To lock up the mirror, compose and focus on your subject and then turn the mirror lock-up lever counter-clockwise until it stops (approximately 90°). After shooting, always return the lock-up lever to its original position.

NOTE: You can lock up the mirror at any photographing stage — before or after advancing the film. However, do not carry the camera in direct sunlight with the mirror locked up. This can result in damage to the shutter curtains.



CHANGING THE CAMERA BACK

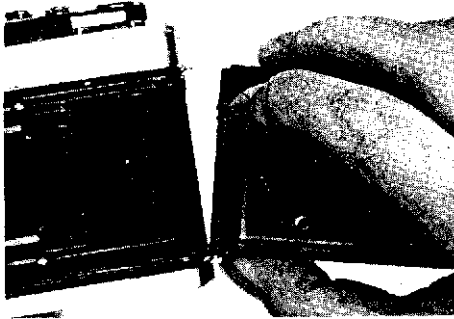

The camera back of the OM-1 is fully interchangeable with the Recordata Back 1 and 250 Film Back 1. To remove the camera back, push down on the release pin as shown. Do not remove the back unless necessary.

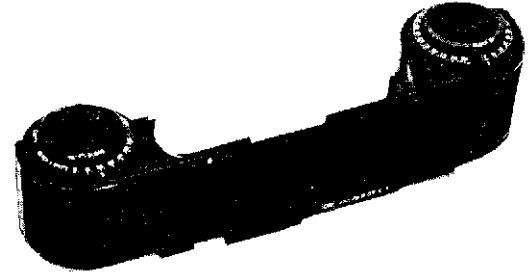
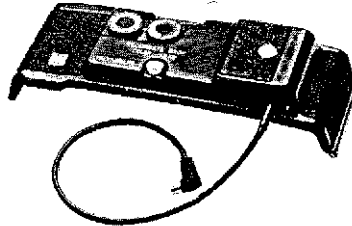

■ Recordata Back 1

The Recordata Back 1 registers data such as date, number, alphabetical code, etc. directly on the picture.

■ 250 Film Back 1

The 250 Film Back 1 is designed for winder or motor drive shooting; it accepts a bulk loaded magazine of 250 frames. (See page 42.)

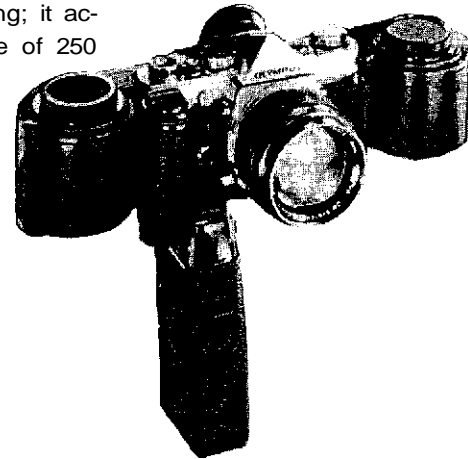

SOME QUESTIONS & ANSWERS

Q: My camera is loaded with film but the rewind knob doesn't rotate when I advance the film advance lever. Why?

A: The film leader may not be inserted in the film take-up spool and the film is not advancing properly. See pages 7 & 8.

Q: The film is not advancing. Why?

A: The shutter may be cocked and ready to fire. Try pressing the shutter release button. If this is not the case, your film may be fully exposed. Check the exposure counter. If you feel tension on the film advance lever, DO NOT FORCE IT. Rewind the film. See pages 9 & 10.

Q: The shutter release button will not move and I can't take the picture. Why?

A: The film advance lever may not have been fully advanced. See page 9.

Q: The rewind crank will not turn when I try to rewind the film. Why?

A: The rewind release lever may not be set properly. Make sure the lever is rotated until the red line is opposite the "R." See page 10.

Q: Why can't I turn the ASA film speed dial?

A: The film speed dial release button must be pressed before the dial can be turned. Once the dial had been set, release the button and make sure the dial has locked into place. See page 12.

Q: Why isn't the needle in the viewfinder moving?

A: First, make sure the meter switch lever is set to the "ON" position. If the meter is on, turn the camera towards a bright light source. If the needle still will not move, the battery may not be inserted, may be inserted improperly or may be drained. Replace the battery or insert it properly. See page 7.

Q: I cannot center the exposure needle on the index. Why?

A: If the exposure needle will not center on the index, adjust the shutter speed or F stop until the needle is centered.

To obtain proper exposure, you may use an ND (neutral density) filter when the subject is too bright, or an electronic flash or flash bulb when the subject is too dark.

Q: How do I take meter readings when a bellows or extension tubes are mounted to my camera?

A: Since lens extension devices disconnect the automatic diaphragm mechanism between camera and lens, readings must be taken with the lens stopped-down. Take an exposure reading using the procedure outlined on page 14.

Q: How can I remove dust from inside the viewfinder?

A: After detaching the focusing screen, blow away any dust with an air blower. (See page 20.) Never wipe the surfaces of the screens, prisms, or mirror with cloth or paper.

Q: The microprism in the center of the viewfinder "shimmers" and darkens. Is that normal?

A: Yes, this is a natural phenomenon that occurs when a lens with a maximum aperture smaller than F5 is mounted on the camera. It also happens with a standard lens when the depth of field preview button is pressed. The microprism is not faulty.

Q: The viewfinder is totally dark and I can't see anything. Why?

A: Make sure you have removed the lens cap. If the cap has been removed, the mirror lock-up lever may be in the up position. Return the mirror to its operational position. See page 29.



CARE AND STORAGE

Q: When I touch the terminal contact of the Accessory Shoe 1 I feel current. Why?

A: This is normal when a side-mounting type flash unit connected to the camera is being turned on. At this point you are not using the accessory shoe so it should be detached. See page 26.

Q: The self-timer lever stopped half-way and plays idly. Why?

A: The self-timer lever stopped half way because the film advance lever has not been transported fully and hence the shutter cannot be released. Turn the start lever counter-clockwise, reset the self-timer lever to the desired time, advance the film fully and turn the start lever clockwise to activate. The self-timer lever plays because you forgot to turn the start lever to release the shutter after you have set the self-timer lever. See page 29.

Q: Can I take the pictures without the motor drive socket cap in place?

A: No, you must replace the cap whenever the motor drive or winder is not attached to the camera's baseplate because dust and dirt may get into the socket causing malfunction and light may enter and fog the film. See page 23.

1. When you do not use the camera for a long period of time, store it with the shutter uncocked and turn off the self-timer and exposure meter. Keep it free from dust and moisture, and remove it from the case.

2. When storing the camera for a long period of time, remove the battery. Wipe battery surfaces with a dry cotton cloth before re-inserting into the camera.

3. Avoid dropping or hitting the camera.

4. Never store the camera where temperatures exceed 50°C (122°F). When you use the camera in temperatures under -20°C (-4°F), it may sometimes fail to operate properly. To avoid this, warm the camera before use. Protect against excess moisture by using silica gel or other desiccant.

5. After use near the ocean, wipe the camera surfaces clean with a soft cloth; never leave salt on the camera. (Salt may be airborne near the ocean and collect on the camera even though it has not been in direct contact with water.)

6. Avoid excessive force when mounting on a tripod.

7. Never expose the camera to direct sunlight. Avoid areas exposed to salt

water, radios, TV sets, or magnets.

8. Have all repairs performed by an authorized OLYMPUS Service Center. You may send it directly or through the store where you bought your camera.

9. Avoid touching the surfaces of the lens. Clean only with an air brush, anti-static brush, or wipe it lightly with a camel hair brush or lens tissue. In EXTREME cases, use a clean, soft cotton cloth moistened with denatured alcohol. NEVER rub the lens surfaces with your finger, clothing, or other abrasive material.

10. If dust or fingerprints collect on the mirror, focusing screen, or prism, take the camera to an authorized OLYMPUS Service Center. It needs professional attention.

11. Do not press the release lever at random.

12. Do not touch any part that moves at high speed such as the shutter, instant return mirror, diaphragm, etc.



ZUIKO INTERCHANGEABLE LENS GROUP

One of many advantages of the single lens reflex type of camera is the large variety of interchangeable lenses available. The Zuiko Interchangeable Lens Group (designed and manufactured by Olympus) comprises 32 lenses including those now in the course of development. Zuiko lenses have always enjoyed a high reputation in photographic circles — new design technology has made possible a new series of innovative, high performance lenses. These lenses have a host of special features including a new construction that compensates for close focus aberrations, increased aperture ratio in the wide angle lenses, and reduction in telephoto lens size and weight. The OM System adopts 49mm filters for most lenses from 21mm to 200mm. As part of the OM System design all the lenses now offer higher performance in small configurations. Olympus has produced lenses for microscopes for many years and the new Zuiko lenses benefit from this scientific experience. See the "OM System Zuiko Interchangeable Lenses" instructions for further information.







TABLE OF INTERCHANGEABLE LENSES

(Specifications subject to change without notice.)

TYPE	INTERCHANGEABLE LENSES		ANGLE OF VIEW	OPTICAL CONSTRUCTION ELEMENT GROUP	DIAPHRAGM	F-STOP RANGE	MIN. FOCUS (ft.)	MIN. PHOTOGRAPHIC RANGE
FISHEYE	ZUIKO FISHEYE	8mm F2.8	180° (circle)	11-7	AUTO.	2.8-22	0.2 m (0.7)	
	ZUIKO FISHEYE	16mm F3.5	180°	11-8	AUTO.	3.5-22	0.2 m (0.7)	
SUPER WIDE	ZUIKO MC	18mm F3.5	100°	11-9	AUTO.	3.5-16	0.25m(0.8)Ⓢ	30×20cm
	ZUIKO	21mm F3.5	92°	7-7	AUTO.	3.5-16	0.2 m (0.7)	21×14cm
	ZUIKO MC	24mm F2	84°	10-8	AUTO.	2-16	0.25m(0.8)Ⓢ	23×15cm
	ZUIKO	24mm F2.8	84°	8-7	AUTO.	2.8-16	0.25m (0.8)	23×15cm
WIDE	ZUIKO MC	28mm F2	75°	9-8	AUTO.	2-16	0.3 m(1.0)Ⓢ	27×18cm
	ZUIKO	28mm F3.5	75°	7-7	AUTO.	3.5-16	0.3 m (1.0)	27×18cm
	ZUIKO MC	35mm F2	63°	8-7	AUTO.	2-16	0.3 m (1.0)	21×14cm
	ZUIKO	35mm F2.8	63°	7-6	AUTO.	2.8-16	0.3 m (1.0)	21×14cm
	ZUIKO SHIFT	35mm F2.8	(83° at max. shift) 63°	8-7	MANUAL	2.8-22	0.3 m (1.0)	21×14cm
STANDARD	ZUIKO	55mm F1.2	43°	7-6	AUTO.	1.2-16	0.45m (1.5)	23×15cm
	ZUIKO	50mm F1.4	47°	7-6	AUTO.	1.4-16	0.45m (1.5)	24×16cm
	ZUIKO	50mm F1.8	47°	6-5	AUTO.	1.8-16	0.45m (1.5)	24×16cm
	ZUIKO MC MACRO	50mm F3.5	47°	5-4	AUTO.	3.5-22	0.23m(0.8)Ⓢ	72×48cm
ZOOM	ZUIKO MC ZOOM	35-70mm F3.6	64°-34°	10-8	AUTO.	3.6-22	0.8 m (2.7)	48 × 72 cm 25 × 37.5 cm
	ZUIKO ZOOM	75-150mm F4	32°-16°	15-11	AUTO.	4-22	1.6 m (5.2)	64 × 42cm 32 × 21cm
TELEPHOTO	ZUIKO MC	85mm F2	29°	6-4	AUTO.	2-16	0.85m(2.8)Ⓢ	25×17cm
	ZUIKO	100mm F2.8	24°	5-5	AUTO.	2.8-22	1 m (3.3)	29×19cm
	ZUIKO MC	135mm F2.8	18°	5-5	AUTO.	2.8-22	1.5 m (4.9)	32×21cm
	ZUIKO	135mm F3.5	18°	5-4	AUTO.	3.5-22	1.5 m (4.9)	32×21cm
	ZUIKO MC	180mm F2.8	14°	5-5	AUTO.	2.8-32	2 m (6.0)	32×21cm
	ZUIKO MC	200mm F4	12°	5-4	AUTO.	4-32	2.5 m (8.2)	36×24cm
	ZUIKO	200mm F5	12°	6-5	AUTO.	5-32	2.5 m (8.2)	36×24cm
SUPER TELEPHOTO	ZUIKO	300mm F4.5	8°	6-4	AUTO.	4.5-32	3.5 m (11.5)	33×22cm
	ZUIKO MC	400mm F6.3	6°	5-5	AUTO.	6.3-32	5 m (16.4)	36×24cm
	ZUIKO MC	600mm F6.5	4°	6-4	AUTO.	6.5-32	11 m (36.1)	55×37cm
	ZUIKO MC	1000mm F11	2.5°	5-5	AUTO.	11-45	30 m (98.4)	98×65cm
SPECIAL USE	ZUIKO MC MACRO	20mm F3.5	9° at highest mag.	4-3	MANUAL	3.5-16	W/Auto Bellows & PM-MT ob	max. 8×5mm min. 3×2mm
	ZUIKO MC MACRO	38mm F3.5	9° at highest mag.	5-4	MANUAL	3.5-16	W/Auto Bellows & PM-MT ob	max. 20×13mm min. 6×4mm
	ZUIKO MC 1:1 MACRO	80mm F4	9° at highest mag.	6-4	MANUAL	4-22	W/Auto Bellows	max. 72×48mm min. 18×12mm



Compatible: The meter needle indicates proper exposures. In the combination marked with *, micrprism, split-prism and edges of the finder darken.



Compatible: The meter needle does not give correct light readings.

WEIGHT (oz.)	LENGTH	MAX. DIAMETER	HOOD	FILTER	1-1 Micro-matte type	1-2 Micro-matte type	1-3 Split-matte type	1-4 All matte type	1-5 Micro-clear field type	1-6 Micro-clear field type	1-7 Micro-clear field type	1-8 All matte type	1-9 Clear field type	1-10 Checker-matte type	1-11 Cross-hairs-matte type	1-12 Cross-hairs-matte type	1-13 Microprism Split image matte type
640g(22.6)	82mm	102mm	—	Built-in													
180g (6.3)	31mm	59mm	—	Built-in		*											
250g (8.8)	42mm	62mm	49→72mm Screw-in	72mm		*											
180g (6.3)	31mm	59mm	49mm Screw-in	49mm		*											
280g (9.9)	48mm	60mm	55mm Screw-in	55mm		*											
180g (6.3)	31mm	59mm	49mm Screw-in	49mm		*											
250g (8.8)	43mm	60mm	49mm Screw-in	49mm		*											
180g (6.3)	31mm	59mm	49mm Screw-in	49mm		*											
240g (8.5)	42mm	60mm	55mm Screw-in	55mm													
180g (6.3)	33mm	59mm	51mm Slide-on	49mm													
310g(10.9)	58mm	68mm	49mm Slide-on	49mm	*	*	*										*
310g(10.9)	47mm	65mm	57mm Slide-on	55mm													
230g (8.1)	39mm	61mm	51mm Slide-on	49mm													
170g (6.0)	31mm	59mm	51mm Slide-on	49mm													
200g (7.1)	40mm	60mm	—	49mm													
400g(14.1)	74mm	67mm	60mm Slide-on	55mm													
440g(15.5)	115mm	63mm	Built-in	49mm													
260g (9.5)	46mm	60mm	49mm Screw-in	49mm													
230g (8.1)	48mm	60mm	49mm Screw-in	49mm													
360g(12.7)	80mm	61mm	Built-in	55mm													
290g(10.2)	73mm	60mm	Built-in	49mm													
700g(24.7)	124mm	80mm	Built-in	72mm													
510g(18.0)	127mm	67mm	Built-in	55mm													
380g(13.4)	105mm	62mm	Built-in	49mm													
1100g(38.8)	181mm	80mm	Built-in	72mm													
1300g(46.0)	255mm	80mm	Built-in	72mm	*		*										*
2800g(98.8)	377mm	110mm	Built-in	100mm	*		*										*
4000g(141.0)	662mm	110mm	Built-in	100mm	*	*	*										*
70g (2.5)	20mm	32mm	—	21mm Slide-on	*	*	*	*						*			*
90g (3.2)	28mm	43mm	—	32mm Slide-on	*	*	*										*
200g (7.1)	46mm	59mm	—	49mm	*	*	*										*



INTERCHANGEABLE LENS GROUP UNITS

■ Filters

In general or many specialized photographic fields, filters are essential to the effective rendition of photographic subjects. Whether in black and white or color, filters are necessary additions to most camera systems. In controlling contrast and eliminating unwanted haze in black and white photography, the use of the correct filter often means the difference between a good photograph and a great one. In color, where the

balancing of the light with the film emulsion is absolutely necessary for correct color, conversion and light balancing filters are the only effective way of achieving the desired results.

* Be careful not to use two filters simultaneously in order to avoid unintentional cut in the periphery of a photograph.

■ Lens Hoods

Lens hoods protect against extraneous light striking the lens and causing un-

wanted glare. Hoods for standard lenses are cover types and can be reversed to provide easy storage even when the camera is in the case.

■ Camera Body Cap

■ Rear Lens Cap

■ Front Lens Caps

(49mm, 55mm, 72mm and 100mm in diameter)

■ Adapter Ring 49 → 72 mm

A lens hood/filter mount for the 18 mm F3.5 lens.

OM System filters are ideal for use with OM System lenses. The use of two filters or other brand may cause vignetting.

Application	Name	Color	Description	Diameter			
				49mm	55mm	72mm	100mm
B. & W. and Color	Skylight (1A)	Colorless	Similar to UV filter. Eliminates ultraviolet rays. Reduces haze and bluish tones in daylight photography. Effective with color film only. May be used at all times to protect the lens.	○	○	○	○
	L39 (UV)	Colorless	Eliminates undesirable ultraviolet rays which cause dull, flat pictures. Renders subject in clear, detailed brilliance. May be used at all times to protect the lens.	○	○	○	○
	ND2 ND4	Grey Grey	Reduces the quantity of light entering the lens to 1/2 or 1/4 of the original intensity. For use in extremely bright conditions when you wish to maintain a wide aperture.	○	○	—	—
	Polarizing filter POL	—	Enables you to take pictures through glass or water without reflections. Will darken the sky in black-and-white photographs without altering other color values in the picture, and renders blue skies darker when used with color film. Reflections are reduced to provide better texture surface detail.	○	○	—	—
B. & W.	Y48 (Y2)	Yellow	Accentuates contrast, darkens blue skies. Very effective in daylight scenes where the sky is part of subject matter. Heightens the effect of white clouds. Useful in copying documents where line copy is blue or black on light background.	○	○	○	○
	O56 (O2)	Orange	Absorbs a wider range of wavelengths from UV to dark green than the Y2. Makes a superb rendition of the texture of outdoors subjects, and indoors. It brings out detail in objects yellow, brown. Used with infrared film.	○	○	○	○
	R60 (R1)	Red	Used as contrast filter to create darkened sky or in copying. Also used to penetrate haze in landscape photography for stronger contrast than an O2 filter. Used with infrared film.	○	○	○	○
Color	A4 (B1C)	Amber	For use when taking color pictures in cloudy or rainy weather. Reduces bluish tone.	○	○	—	—
	B4 (B2C)	Blue	Designed for use when taking color pictures in early morning or late evening hours when red rays are predominant.	○	○	—	—



MOTOR DRIVE GROUP

Designed specifically to match the OM camera body, the Motor Drive Group has been reduced in size to enhance its maneuverability and ease of operation. The Winder 1, which operates on self-contained batteries, and the basic combination (Motor Drive 1 + M. 18V Control Grip 1, or Motor Drive 1 + M. 15V Ni-Cd Control Pack 1) are designed to be the smallest in the world. Each of the handgrip type winder and motor drive, the pistol type control grip and the flat type rechargeable power unit provides a built-in shutter release button so that the photographer can hand-hold even a 300mm telephoto lens for shooting sports or other action subjects. A 250 exposure roll film back and other units attach to the OM camera body without cords. This Motor Drive Group is also a convenient accessory when used with other groups for macrophotography, photomicrography, etc. A remote control mechanism is also available for a series of exposures taken intermittently in conjunction with the M. AC Control Box, or a series of exposures with bulk films.

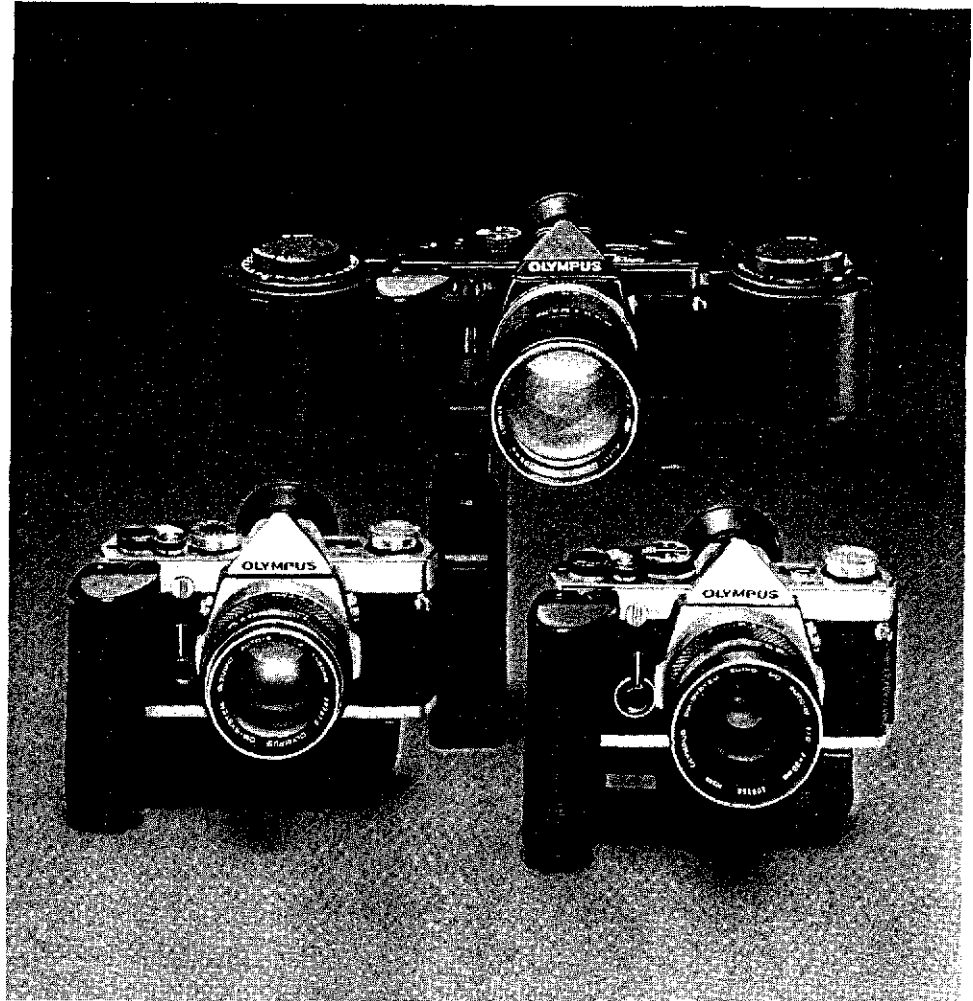

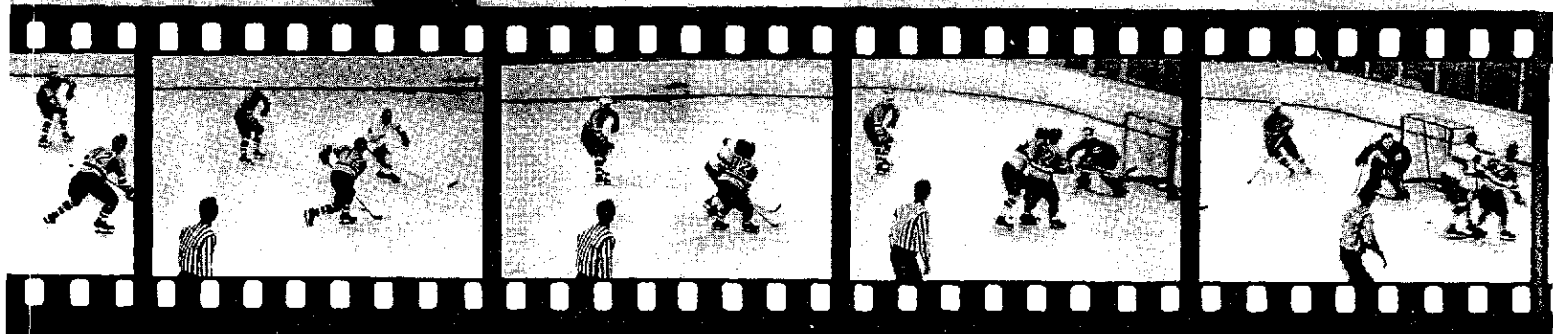
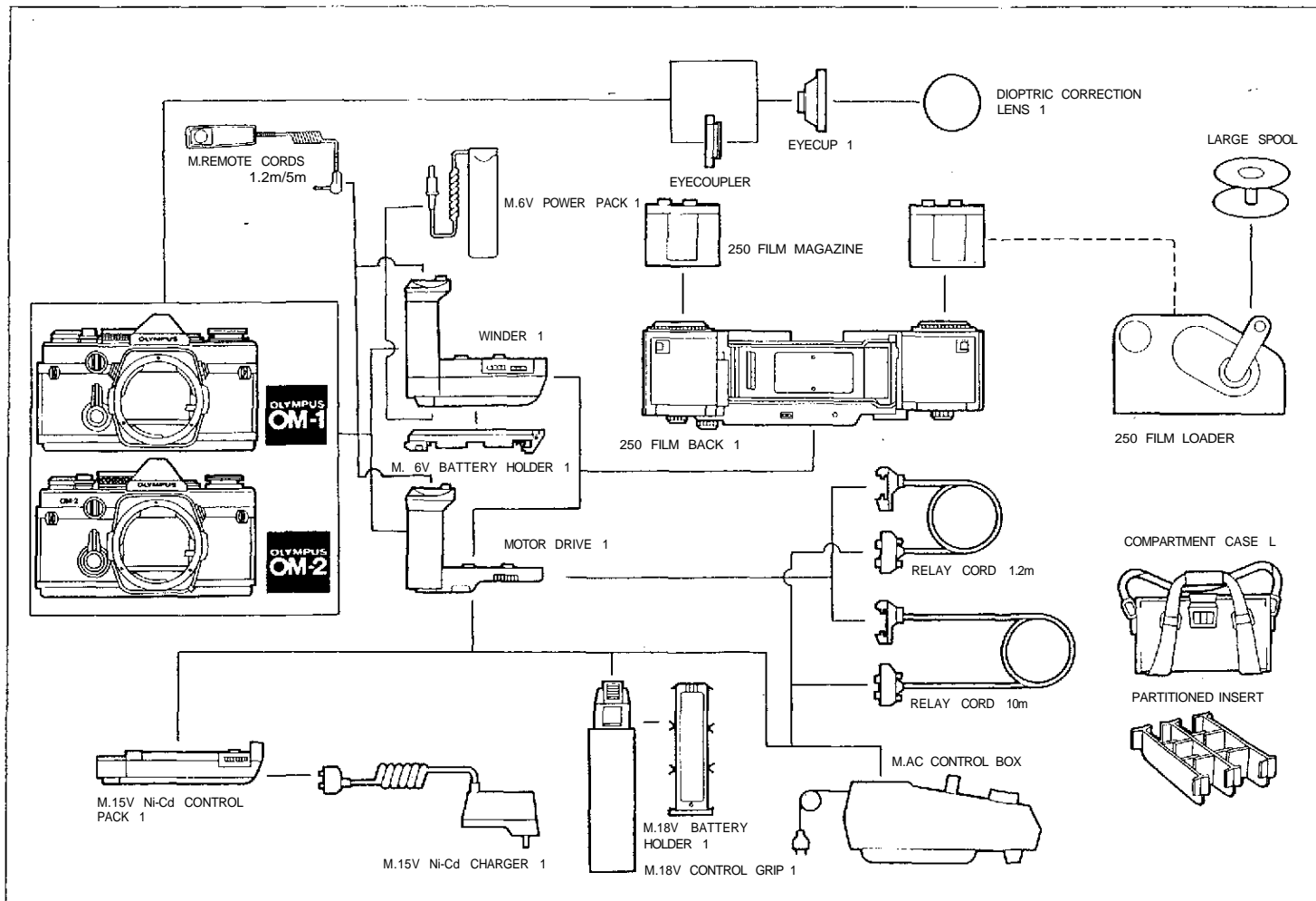



CHART OF MOTOR DRIVE GROUP





MOTOR DRIVE UNITS

■ Winder 1 (with M. 6V Battery Holder 1)

Fixed directly to the camera base tripod socket, the Winder 1 functions integrally with the OM camera body to perform single frame shooting.

The unit winds the film in approx. 0.3 sec. as soon as the exposure is made, whenever the shutter release is pressed.

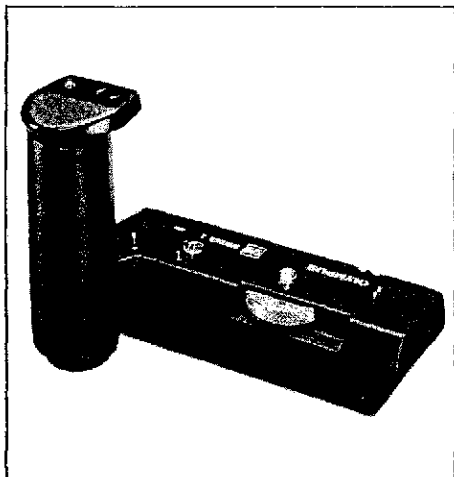

Operating on self-contained 4 AA Alkaline batteries, it is capable of powering approx. 50 rolls of 36-exposure film.

Size: 130 X 64 X 100mm (5.12 X 2.52 X 3.94 in.) Weight: 290g (10.2 oz.) (less batteries)

■ M. 6V Power Pack 1

This pocketable power unit (4 AA batteries) connects to the Winder 1 via

■ Motor Drive 1

The basic motor drive unit that forms the foundation of the group. Fixed directly to the camera-base tripod socket together with the power supply, it functions integrally with the OM camera body. Operating on various power sources such as penlight batteries, Ni-Cd batteries, or AC, it is capable of

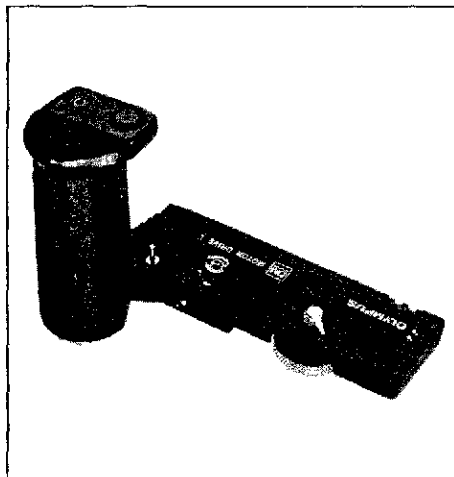

single frame shooting and max. sequential filming of 5 frames per second.

Size: 116 X 82 X 66mm (4.57 X 3.23 X 2.59 in.) Weight: 210g (7.4 oz.)

a 1.2m cord. Warmed by photographer's body heat, permits operation in temperatures as low as -10°C (14°F).

■ M. 18V Control Grip 1 (with M. 18V Battery Holder 1)

A power supply that accepts 12 AA Alkaline or Ni-Cd batteries. Can be attached quickly to the Motor Drive 1. Complete with a built-in release button, single and sequence selector switch and release lock lever.

Size: 136 X 87 X 32mm, Weight: 160g (less batteries)

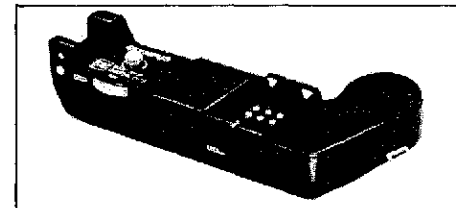

■ M.15V Ni-Cd Control Pack 1

This is a flat-type rechargeable power unit equipped with a special built-in Ni-Cd battery to power the Motor Drive 1, and provides maximum continuous filming rate of 5 f.p.s. as well as the single release capability.

Size: 129 X 35 X 67mm, Weight: 260g

* Specifications subject to change without notice.

■ **M.AC Control Box**

AC transformer for use with household current. Incorporates a selector switch between single-frame operation and sequential exposure operation, a terminal for the relay cord and a timer for exposures in intervals from 4 frames per second to one frame every 120 sec.

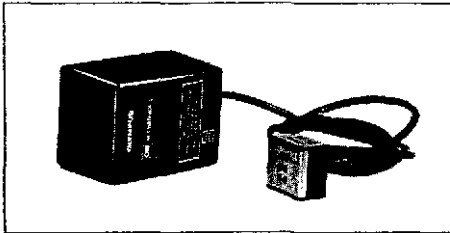
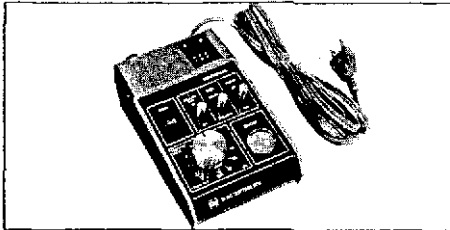

■ **M.15V Ni-Cd Charger 1**

This unit is necessary to charge the M.15V Ni-Cd Control Pack 1. By charging for about 4 to 5 hours, the Control Pack is capable of powering sequential filming of 40 rolls of 36 exposure films.

■ **250 Film Back 1, 250 Film Magazines**

Can be quickly attached to the OM Body in place of the standard camera back, and used with the Motor Drive 1 or Winder 1 for roll films up to 250 exposures (10m or 32.8 ft long). Two Magazines are necessary, one magazine holds the bulk film and a second magazine is used as a film take-up.

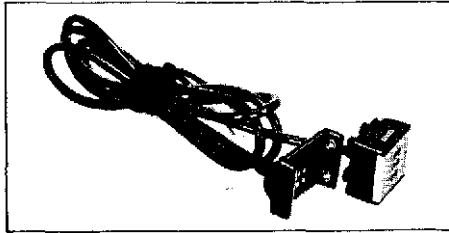

■ **Relay Cords 1.2m and 10m**

Extension cords for remote control; one is 1.2m (3.9ft), the other is 10m (32.8ft).

■ **250 Film Loader**

This unit is used in the darkroom for loading the 250 Film Magazine from 33m (100ft.) bulk film rolls. A built-in mechanism automatically stops loading at preset film lengths.

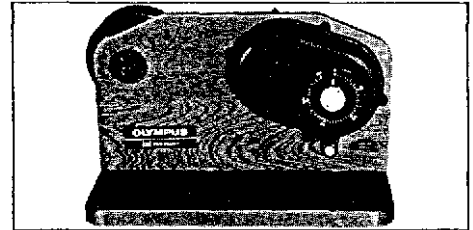

■ **Compartment Case L**

■ **Partitioned Insert**

The Compartment Case L is a hard dual-purpose shoulder or hand-carried case with two adjustable partitions. Capable of holding the Motor Drive set by use of the optional partitioned insert. (p. 70)

■ **M.REMOTE CORDS 1.2m/5m**

The M. Remote Cord remote-controls the Olympus Motor Drive 1 and Winder 1 units equipped with a remote control jack by a flick of a switch.



FINDER GROUP AND UNITS

The viewfinder is one of the most important features of a single lens reflex camera. Since every photographic subject is turned into a visual image by means of the finder, a finder that is dark or difficult to look through is an obstacle to good photography. However enriched an SLR camera is with a wide range of interchangeable lenses, the SLR cannot be expected to fulfill its essential function without the provision for changing of focusing screens. The OM-1 is provided with a viewfinder that offers a far brighter, larger image than conventional 35mm SLR cameras. The Finder Group supplements this basic advantage with a comprehensive set of 13 focusing screens for a wide variety of applications from photomicrography to astrophotography. Unless the most suitable focusing screen for given photographic purpose is available, the potentialities of a system camera cannot be utilized. For fast, accurate focusing, the OM System Finder Group offers the unique Vari-magni Finder with a magnification selector, the Eyecup 1 that accepts a variety of Dioptic Correction Lenses, Eyecoupler, etc.

■ Vari-magni Finder

This unique and exclusive unit for the OM System combines the two functions of angle finder and magnifier, incorporating 9 lens elements and a reflector. It fits over the camera's eyepiece, and can be adjusted for individual eyesight. Its eyepiece tube is rotatable through 360°,



for use in low level and 90° angled shots. The two-stage, one-touch switching system offers both a 1.2x magnification image covering the whole screen, and a 2.5x enlargement of the central portion for critical focusing. For photomicrographic use, insert the Eyecoupler between the camera and Vari-magni Finder.

■ Eyecup 1

Attached by sliding over the OM Body eyepiece. With its attached rubber hood it prevents stray light from entering through the eyepiece, an essential requirement in light measuring. The Eyecup 1 is provided with a slot to accept a dioptic correction lens.

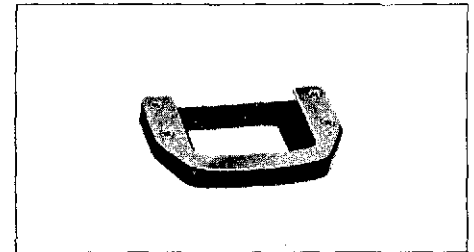

■ Eyecoupler

Connects the Vari-magni Finder to the OM Body for photomicrography. It also ensures full coverage of the bright viewfinder field for use of the Eyecup 1 in conjunction with the Motor Drive 250 Film Back 1.

■ Focusing Screens

Interchangeable Focusing Screens are often thought of as a luxury feature in 35mm photography. Yet the Standard Focusing Screen 1-13 is often inconvenient or difficult to use, and in some circumstances it is quite unsatisfactory. With super-telephoto lenses for instance, the microprism becomes excessively dark. With the high magnifications of macro-photography and photomicrography, it is impossible to focus.

The feature of each Focusing Screen is listed at right. The 1-3 and 1-13, suitable for general photography, are particularly advantageous when taking a subject with vertical lines. The 1-5 is ideal for the snap-shooters using a wide angle lens. The 1-4 and 1-7 are designed for super-telephoto lenses and 1-4, 1-10, 1-11 and 1-12 are for close-ups, macro-photography and photomicrography. The 1-5, 1-6, 1-7 and 1-9 are not used with the exposure meter built in the camera.



■ Dioptic Correction Lens 1

Available in 8 diopter corrections: +2, +1, 0 (for hypermetropia); -1, -2, -3, -4, -5 (for myopia). Used to correct the photographer's vision, and especially necessary in fine focusing for high magnification. Fits into the Eyecup 1.

TYPE	FEATURES	TYPE	FEATURES
1-1 Microprism-matte type (for most lenses)	Standard type, suitable for general photography. Fast and accurate focusing is done on the central microprism spot as well as on the surrounding matte area. When a lens with a maximum speed of F5.6 or slower is used, the microprism darkens and focusing must be made on the matte area. The meter needle indicates proper exposures.	1-8 All matte type (for telephoto lenses & astronomical telescopes)	This screen is ideal for use with super telephoto lenses of 300mm or more in focal length, or for astrophotography. The extreme fineness of the matte surface permits outstanding field definition. More accurate focusing may be achieved by the use of the Varimagini Finder.
1-2 Microprism-matte type (for standard & telephoto lenses)	Suitable for general photography in conjunction with a standard or telephoto lens. Focusing is done on the microprism spot as well as on the matte area. When a lens with a maximum speed of F8 or slower is used, the microprism spot darkens. The meter needle indicates proper exposures.	1-9 Clear field type (for endoscopic photography)	Designed for use with OLYMPUS fiberoptic endoscopes. This condenser type screen without fresnel lens requires no focusing when a special adapter couples the camera with the fibroscope. Exposure is made automatically by the light supply.
1-3 Split image-matte type (for most lenses)	Suitable for general photography ensuring critical focusing, and ideal for photographers who prefer the split-field and coincidence type focusing. When a lens with a maximum speed of F5.6 or slower is used, the split prism darkens. The meter needle indicates proper exposures.	1-10 Checker-matte type (for Shift lens)	The reticule engraved on the all-matte surface is used for vertical and horizontal picture alignment. Though originally designed for architectural photography with the Shift lens, it is also suitable for general and super-telephotography, and close-up/macro-photography with macro lenses and Auto Bellows.
1-4 All matte type (for most lenses)	Suitable for general photography and ideal for photographers who prefer a view field free from microprism or split prism and for those who are accustomed to focus using matte area. Also suitable for super telephoto photography and close-up photography in conjunction with macro lenses and Auto Bellows. The meter needle indicates proper exposures.	1-11 Cross hairs-matte type (for close-up & macro-photography)	Highly advantageous for close-up and macro-photography with Auto Bellows and extension tubes. For focusing in low magnification close-up photography, use this matte area, and in macro-photography greater than life size, use the double cross hairs the same way as with the 1-12. The meter needle indicates proper exposures, but depending on the conditions of the specimen, the reading must be compensated for.
1-5 Microprism-clear field type (for wide angle & standard lenses)	This transparent screen provides an exceptionally bright finder image. Highly suitable for snapshots using wide angle lenses. The lack of matte surface means depth-of-field effects cannot be ascertained. The meter needle does not indicate proper exposures, because its movement varies depending on the lenses used.	1-12 Cross hairs-clear field type (for photomicrography & macro-photography greater than life size)	The transparent screen offers the photographer focusing with an unusually bright finder image. To focus, first correct your diopter using a dioptic correction lens or Varimagini Finder so that each line of the double cross hairs can be seen clearly and separately. Then bring the specimen into focus. The meter needle indicates proper exposures, but depending on the specimen's conditions, the reading must be compensated for.
1-6 Microprism-clear field type (for standard & telephoto lenses)	This screen provides an extremely bright finder image. Focusing is done on the microprism spot. The lack of matte surface means depth-of-field effects can not be ascertained and the meter needle does not indicate proper exposures.	1-13 Microprism/split image-matte type (for most lenses)	Most suitable for normal photography, this screen assures pinpoint focusing. The central split-image rangefinder is encircled by a microprism collar. Since the outer area has a matte surface, the screen can be used in the same way as the standard 1-1 and 1-3 Screens. When a lens with a maximum speed of F5.6 or slower is used, the prism darkens and the focusing must be made on the matte area.
1-7 Microprism-clear field type (for super telephoto lenses)	Developed primarily for use with super telephoto lenses, this clear field screen provides an extremely bright finder image. The microprism spot remains bright even with a lens whose maximum speed is F11. The lack of matte surface means depth-of-field effects cannot be ascertained; the meter needle does not indicate proper exposures.		



FLASHPHOTO GROUP

Flash is your own private "sun" when you take pictures at night, indoors, or daylight fill-in. At the moment of flash, you can even catch the movement of subjects that your own eyes are unable to follow.

At present the OM System Flashphoto Group renders a choice of 3 different flash units, including the Quick Auto 310.

The Quick Auto 310 is the heart of the Group. Small and lightweight, it nevertheless offers high performance — a maximum ASA 100 (in meters) guide number 34 with an angle that virtually covers the picture area of a 24mm super wide-angle lens.

Beside the 3 automatic settings, 2 manual settings are also available in a single dial operation. During manual operation, flash intensity is freely controllable for fill-in lighting in daylight scenes, while the use of the Remote Sensor and Bounce Grip units allows automatic bounce flash.

(The Quick Auto 310 is regulated by the SBC light sensors and electronic brain built into the OM-2 to automatically control the light emission level of the flash unit.) Except at TTL Auto setting, it functions in the same way as normal autoflash unit.

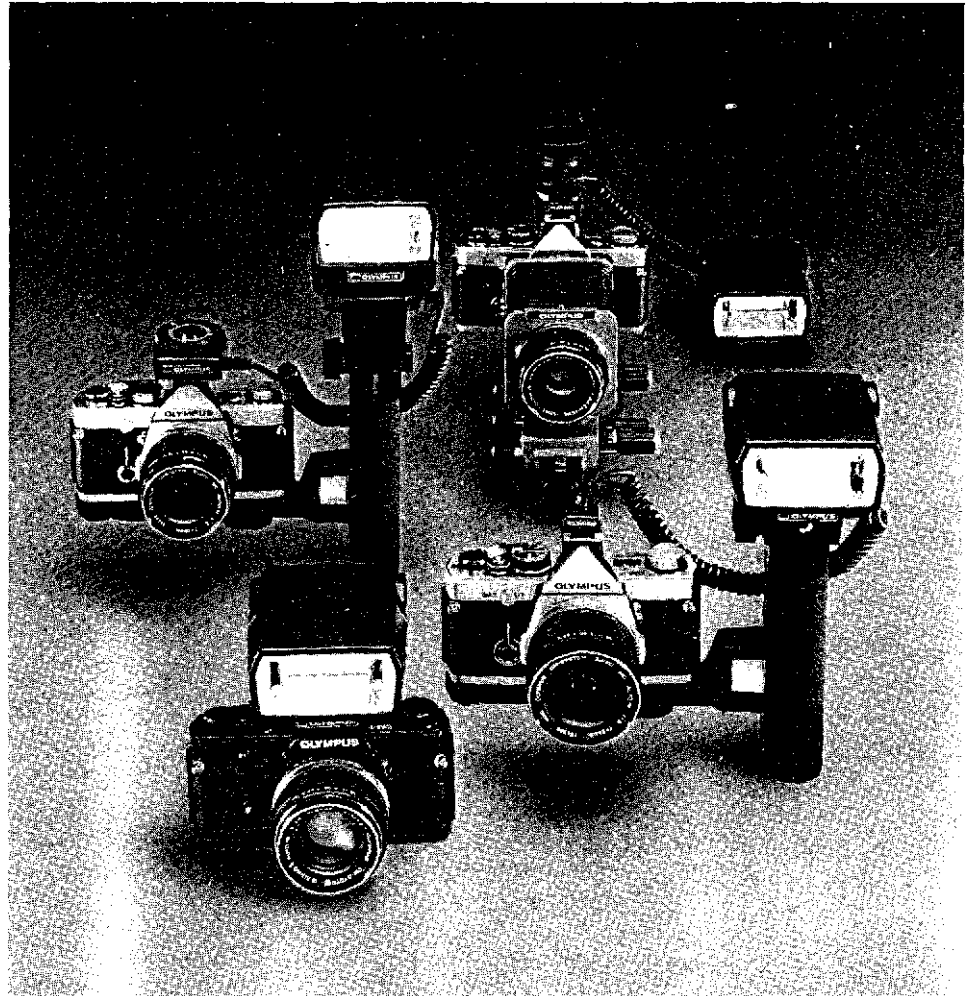
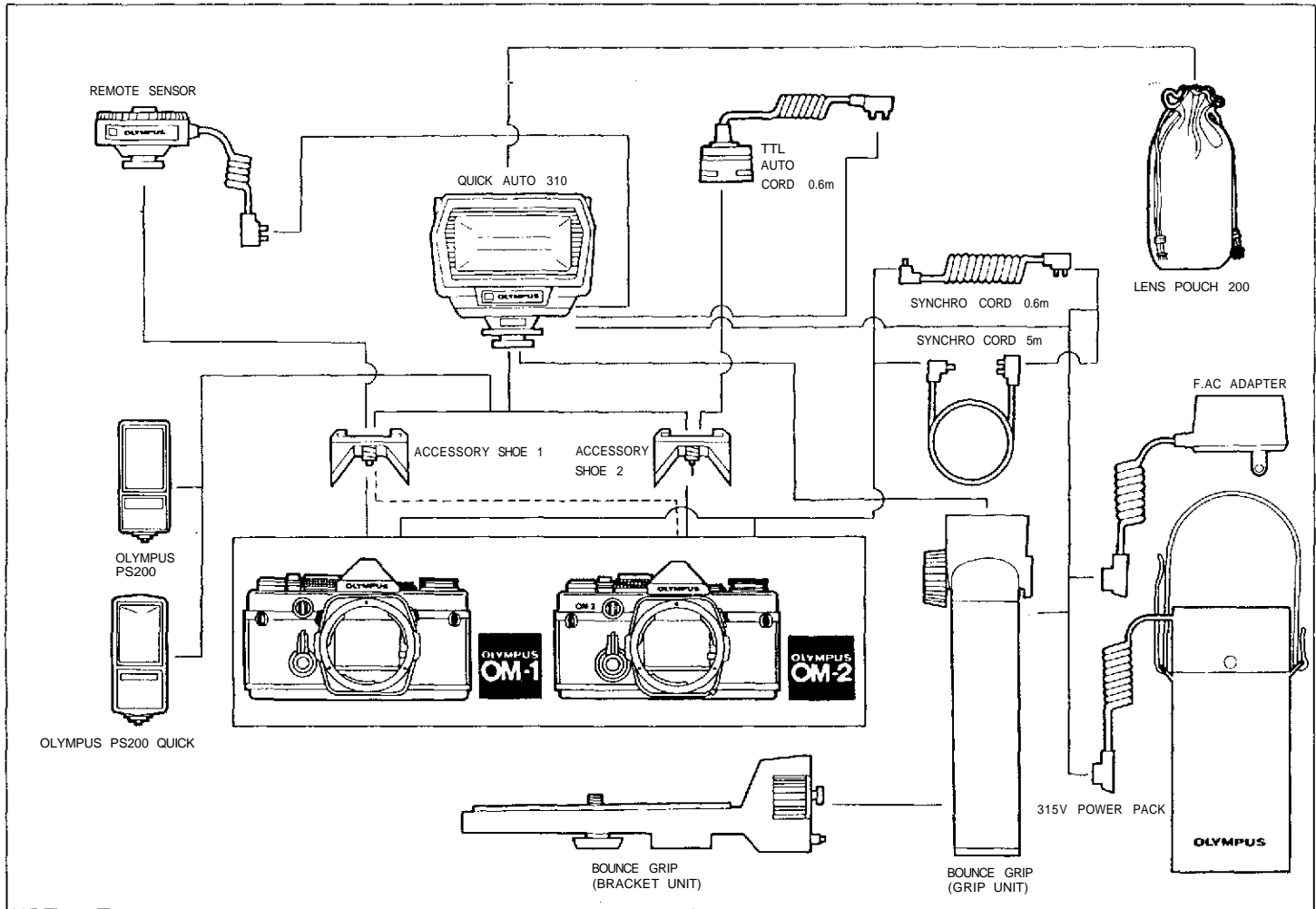





CHART OF FLASH PHOTO GROUP





FLASHPHOTO GROUP UNITS

■ Quick Auto 310

With a guide number of 34 (ASA 100, meters), this is the most powerful flash unit generally available, offering a wide coverage to give enough illumination over the picture area of a 24mm super wide-angle lens without the aid of a wide adapter.

(The Quick Auto 310 employs the world's first "TTL Centralized Control Flash" System: the SBC sensors of the OM-2 TTL Direct Light Measuring system work also as a flash-light sensor. The System features: 1) the light acceptance angle accords with the picture angle of individual lens attached to the camera, 2) the ASA film speed and f/stop needn't be set on the electronic flash unit, 3) all f/stops of the lens can be used continuously, 4) the close-distance autoflash range is expanded, and 5) automatic bounce and diffuse flash, and extreme close-up with the Auto Bellows can be readily performed.) With cameras other than the OM-2, the flash unit provides ordinary automatic flash capability at F4, F5.6 & F8 (ASA 100). HI and LOW (1/4 power) manual settings are possible. Also incorporates an auto check lamp. Operates off 4 pen-light batteries with any direct contact camera. Can be used together with the Bounce Grip, permitting a choice of various power sources. (Nickel-

cadmium batteries cannot be used.)

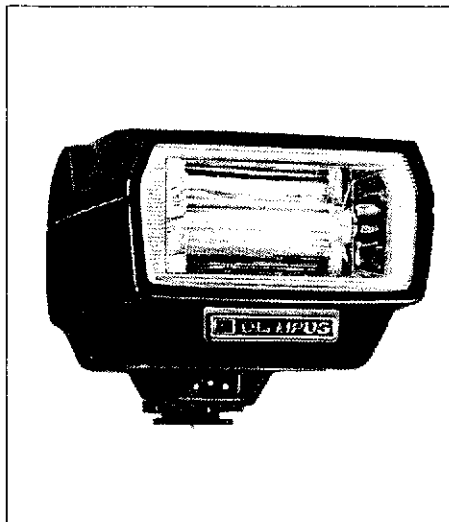

■ Bounce Grip

This unit consists of the grip and bracket. The bracket can be connected to the grip instantly and slid to a desired position; capable of tilting through an angle of 90°. Four 1.5V C batteries are inserted into the grip to make it a higher-output power source. It also

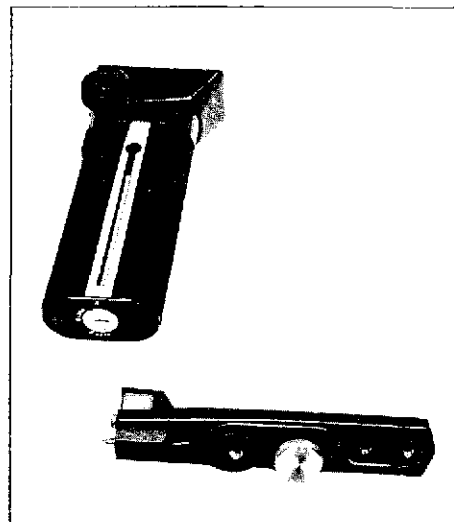

allows automatic flash photography in bounce light in conjunction with the Remote Sensor. (Nickel-cadmium batteries cannot be used.)



FLASHPHOTO GROUP UNITS

■ Accessory Shoe 1, 2

The Accessory Shoe 1 is screwed into the hot shoe socket on the OM Body to provide direct contact with the clip-on type electronic flash. This unit also works as a holder for the Remote Sensor. The Accessory Shoe 2 is for use with the OM-2 and Quick Auto 310.

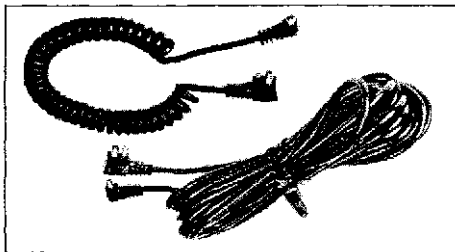
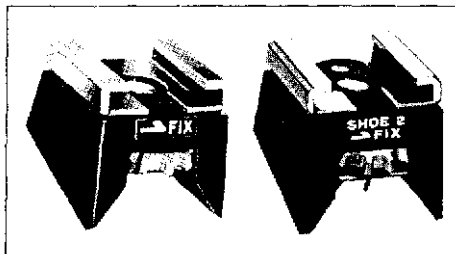

■ Synchro Cord 0.6m, 5m

Convenient to use with the Quick Auto 310 for direct flash on a cold shoe, or with the Bounce Grip for off-camera flash. The Synchro Cord 5m is for greater off-camera distance than with the 0.6m.

■ Remote Sensor

Designed for use with the OM-1, correct flash exposures can always be made no matter what bounce angle is, even when the Bounce Grip is detached from the OM-1, thus easily permitting auto bounce flash.

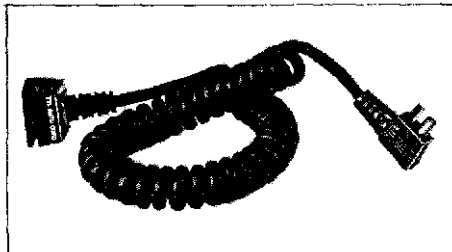

■ TTL Auto Cord 0.6m

Designed for use with the OM-2, Accessory Shoe 2 and Quick Auto 310 to perform off-camera TTL auto flash, TTL auto bounce flash (with Bounce Grip), etc.

■ 315V Power Pack

A layer-built battery pack to be hung from the photographer's shoulder. The unit generates over 500 flashes at full power flash with short recycling time (approx. 1.5 sec.).

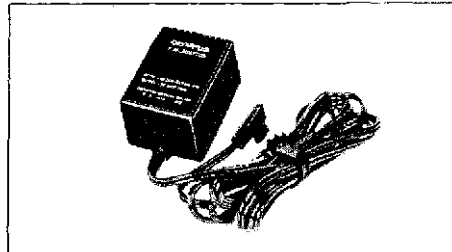
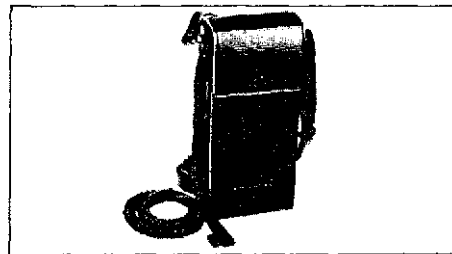

■ F.AC Adapter

Plugged into an AC wall outlet, through which the AC household current supplies an almost unlimited number of flashes economically to the Quick Auto 310 and Bounce Grip.

■ **Lens Pouch 200**

Accommodates the Quick Auto 310.

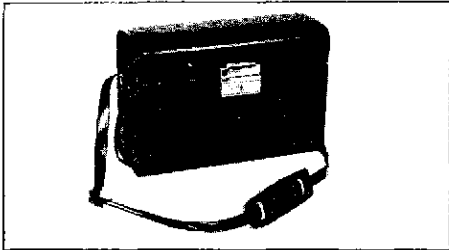

■ **Compartment Case S**

A hard shoulder case with two adjustable partitions, to accommodate the OM Body, Quick Auto 310, Bounce Grip, and Bracket.

■ **OLYMPUS PS200**

The PS200 operates on two 1.5V penlight batteries for use with all the current OLYMPUS cameras and any other cameras with hot shoe contact. Guide number 14 (in meters) (or 45 in feet) at ASA 80-100. Suitable to daylight type color films. Recycling time approxi-

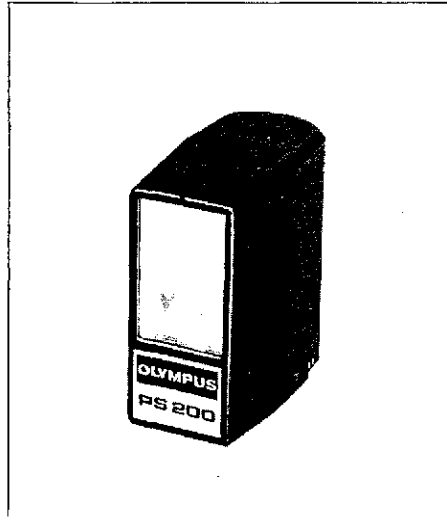

mates 7 sec. and number of flash 200 times with fresh alkaline batteries. Measures 31 X 55 X 64mm (1.2" X 2.2" X 2.5"), weighing 75g (2.6 oz.) without batteries.

■ **OLYMPUS PS200 Quick**

The PS200 Quick is a compact electronic flash unit that operates on four 1.5V penlight batteries (alkaline or carbon/zinc) for use with the hot shoe cameras. This unit features a short recycling time from 2 sec. to 3 sec. Guide number 14 in meters (45 in feet), for



color and B&W films, ASA 80-100. Suitable to daylight type color films. Flash duration 1/1000 sec. Number of flash about 200 with alkaline batteries. Measures 32 X 73 X 71mm (1.3" X 2.9" X 2.8"), weighing 95g (3.4 oz.) without batteries.



MACROPHOTOGRAPHY GROUP

Due to recent advances in macrophotography, it has become possible to pry out patterns and colors of unsuspected beauty in the minutiae of nature. A fast growing number of scientists and amateurs are taking the opportunity to explore the living world around them in a new depth.

The Macrophotography Group of the OM System provides them with all the tools necessary to capture this world of perfection on film, offering a complete range of convenient, high performance system units designed for specialists in the various fields of macrophotography. Starting from close-up photography with relatively simple units such as Close-up Lenses, and Extension Tubes, you can extend your photographic techniques into the macrophoto world with the four Macro Lenses, Auto Bellows, Stands, Adapters, and a large variety of lighting equipment. This Group has no equal in its wide variety of accessories for macrophotography with a magnification range from 1/10X to about 10X and heightens the value of the OM System in pursuit of perfection on film.

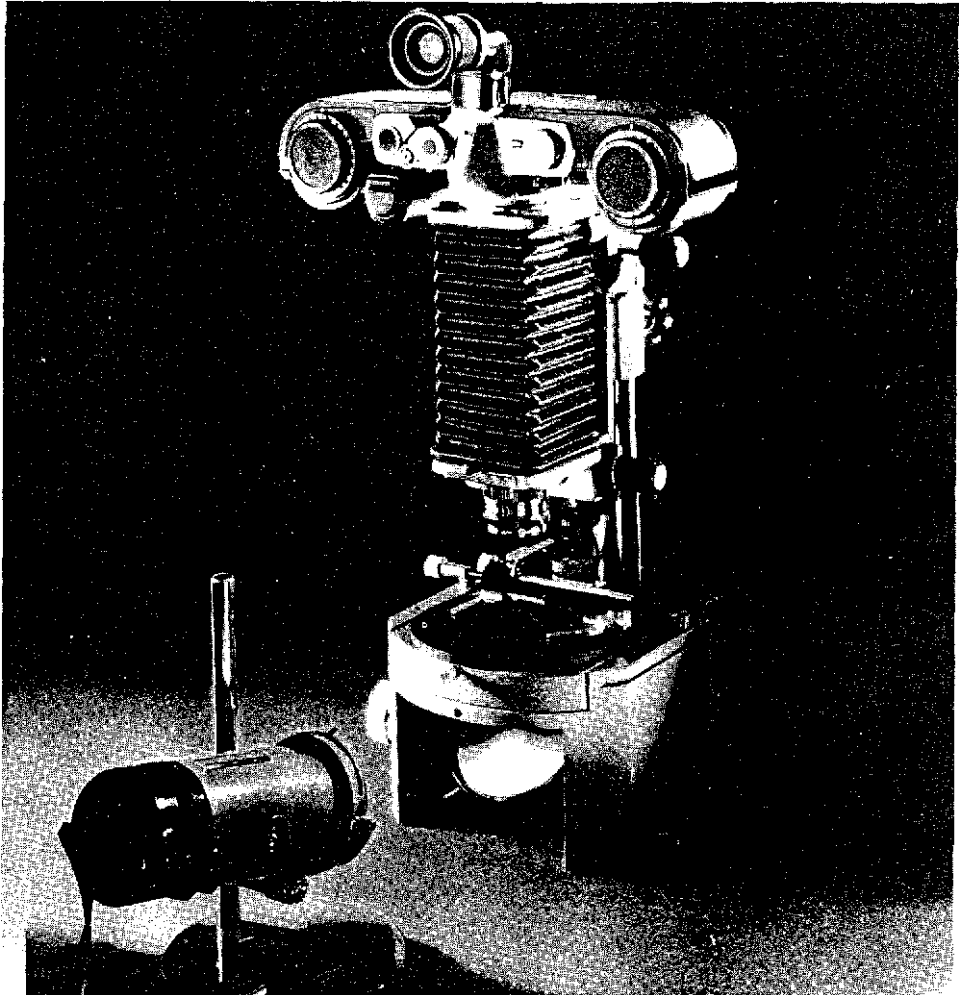

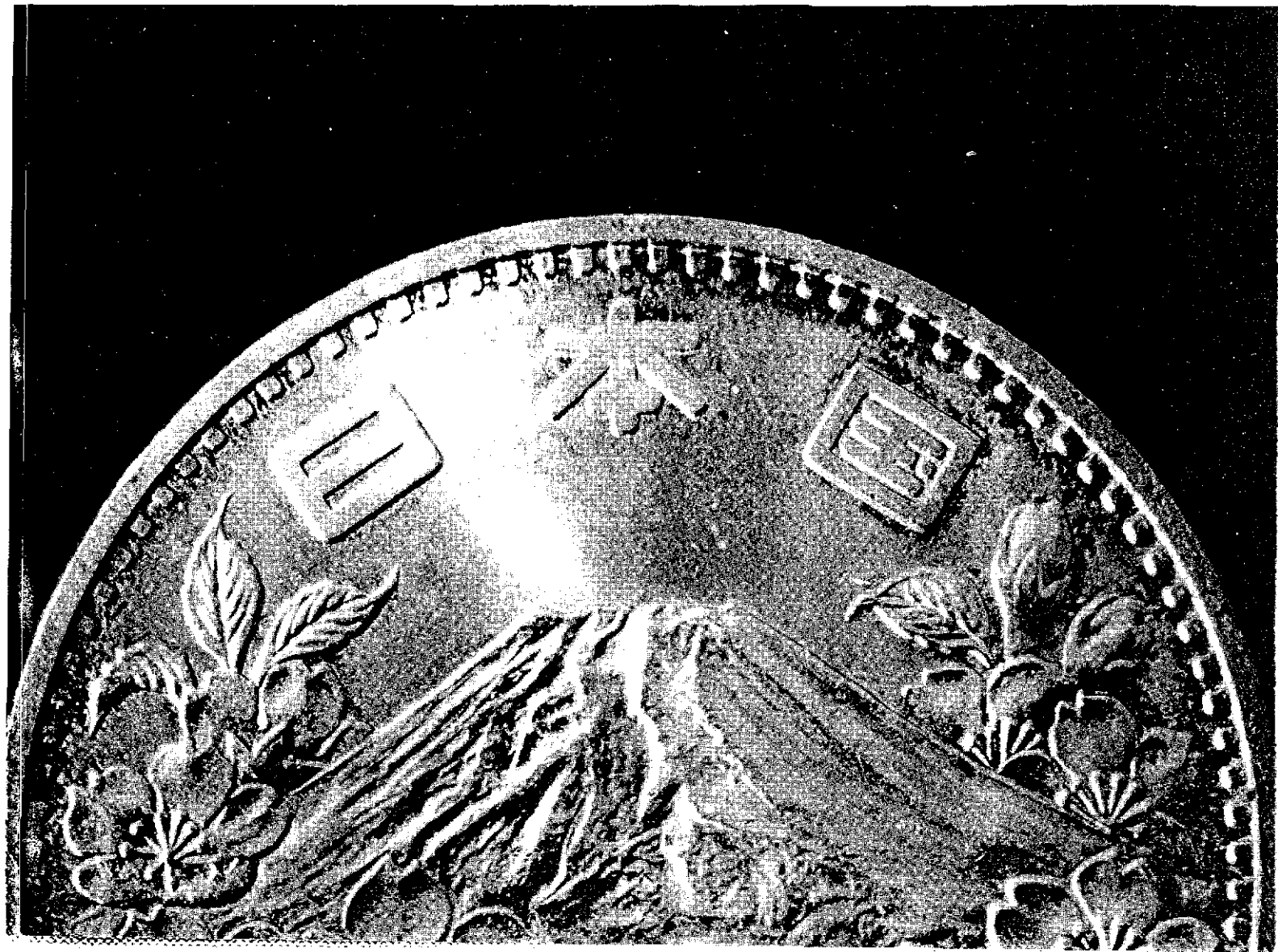
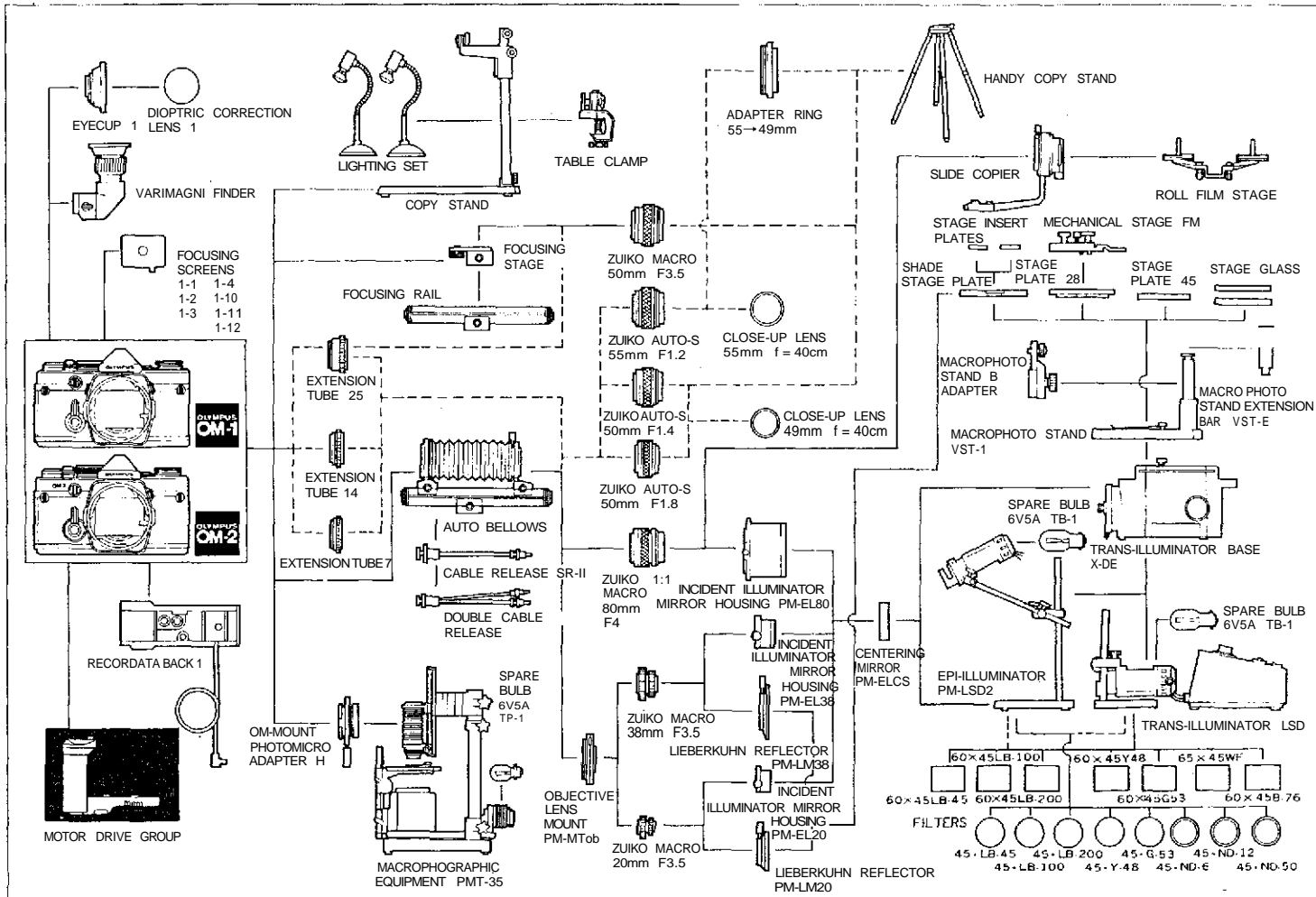



CHART OF MACROPHOTOGRAPHY GROUP





MACROPHOTOGRAPHY UNITS

■ Close-up Lens 49mm f=40cm

■ Close-up Lens 55mm f=40cm

Available in both 49mm and 55mm diameters to fit all suitable OM System lenses. The use of them reduces the minimum focusing distance of a standard lens from 45cm (17.7") to 19cm (7.5") from the front lens surface.

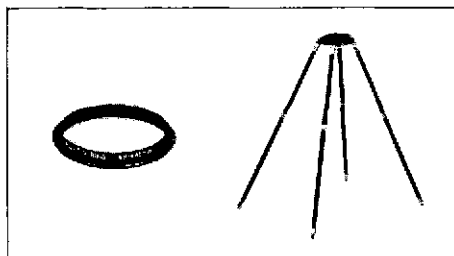
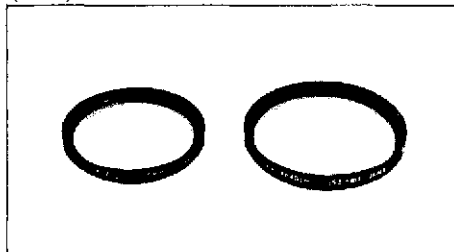

■ Handy Copy Stand

A four-legged stand for close-up and copy photography. The leg length is adjustable to three positions.

■ Adapter Ring 55 → 49mm

Connects the standard F1.2 to the Handy Copy Stand or the reversed 55mm dia. lenses to the Auto Bellows.

■ Extension Tubes 7, 14 and 25

Bayonet mount tubes fitting between the OM Body and the lens. They have extension of 7mm, 14mm and 25mm respectively, and can be used in total of 7 different combinations to give a variety of magnifications. When used with the standard F1.8 the lens-to-sub-

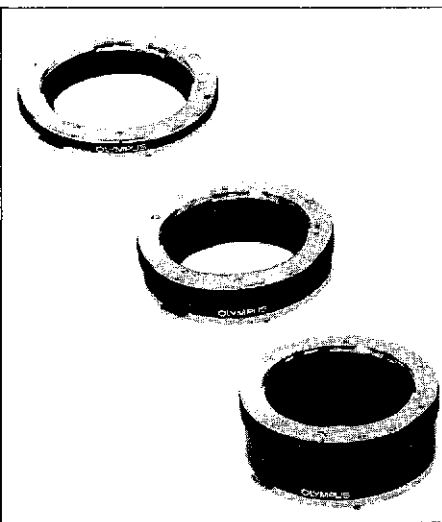

ject distance can be changed from 39.1cm to 6.8cm (15.4" to 2.7"). With the Macro 50mm, the Extension Tube 25 provides an extended magnification range between 0.5x to life-size. (In this range, however, the 1:1 Macro 80mm is recommended for the best result.)

■ Copy Stand

A standard type stand, 48 x 44cm, for general close-up and copy photography. Two additional lights can be constructed to the top of the 80cm high stanchion. Fine adjustment for the camera height and a locking device are provided.

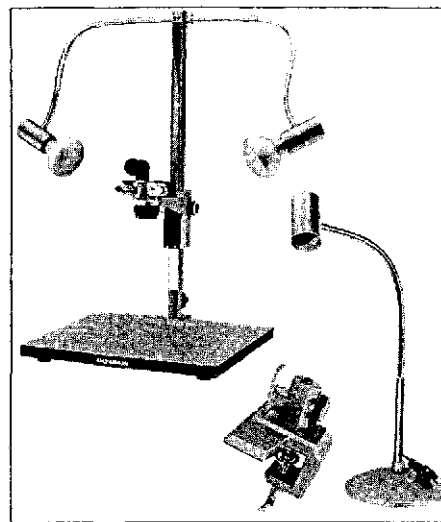

■ Lighting Set

Complete with two units each consisting of a stable base and a light arm. Maximum light intensity is 500W.

■ Table Clamp

Convenient for setting up the column of the Copy Stand at the edge of a desk or table without the baseboard.

■ Auto Bellows

A convenient, high performance bellows system, consisting of the bellows section, focusing rail and focusing tripod mount. Magnification and focusing adjustable independently. A Must for three Macro Lenses. Can also be used with the Focusing Stage.

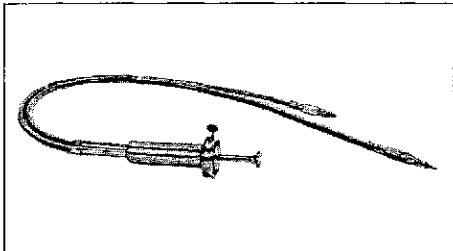
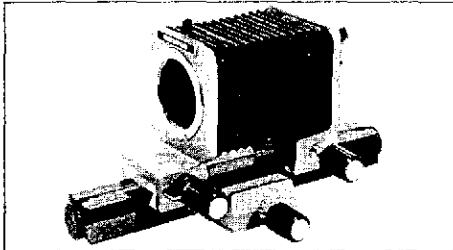

■ Double Cable Release

Attached to the Auto Bellows and camera shutter release button, to activate them simultaneously.

■ Focusing Rail

This is used with the Focusing Stage and connects to a tripod, the Copy Stand, or Macrophoto Stand B Adapter, so that the camera can be smoothly moved along the Rail, allowing you to focus and compose as desired.

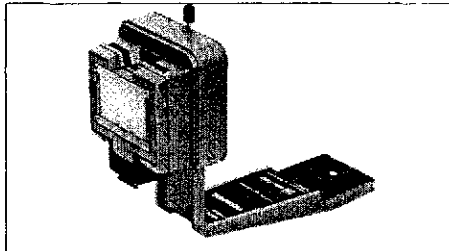
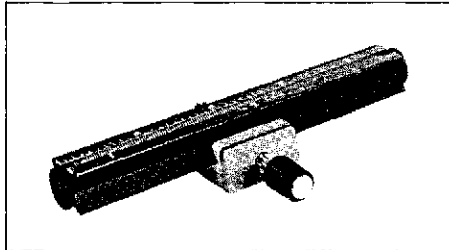

■ Slide Copier

For use in conjunction with the Auto Bellows to produce duplicates from frame-mounted slides or strip slides. The 1:1 Macro 80mm is recommended for best results with the Slide Copier.

■ Focusing Stage

Allows you to mount the camera body on the Focusing Rail or Auto Bellows. When used with the Rail, you can change the camera position for fast and smooth focusing and composing.

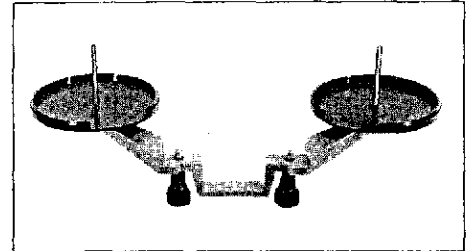
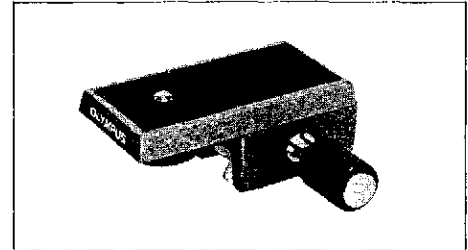

■ Roll Film Stage

Attached to the Slide Copier to hold long roll films for duplication.

■ **Macrophoto Stand VST-1**

A rugged stand specially designed for close-up and high magnification photography. Usable with various stage plates. Complete with a round frosted plate (black at back) for incident light and a pair of stage clips.

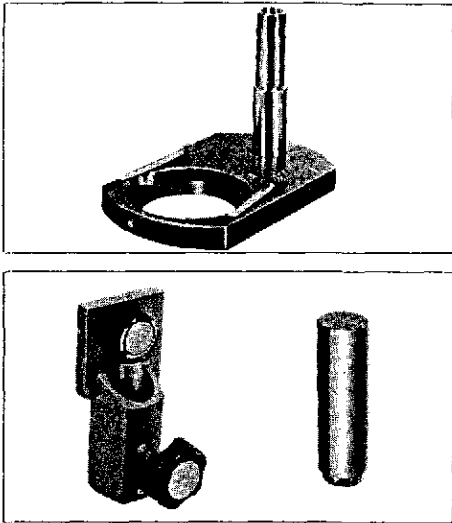

■ **Macrophoto Stand B Adapter**

For use with the Macrophoto Stand, to support the Auto Bellows or Focusing Rail on the Stand.

■ **Macrophoto Stand Extension Bar VST-E** Extends the height of the Macrophoto Stand. Length: 7.5cm (2.95")

■ **Trans-Illuminator Base X-DE**

Indispensable for holding the Macrophoto Stand VST-1 for magnified photographs. Supplied with a built-in 100W 20W illuminator with a mirror, and a pair of wooden handrests for ease of operation. Can be used with various stage plates and filters. When used with

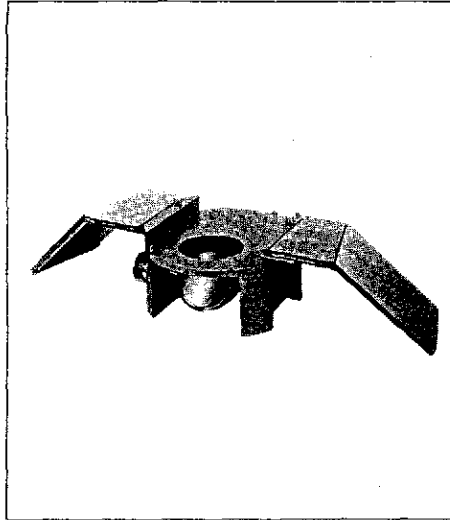

the Lieberkuhn Reflector, it is convenient to replace the reflector mirror with the Centering Mirror PM-E LCS.

■ **Cable Release SR-II**

For use with the OM Body or Auto Bellows to eliminate shutter vibration at shutter release.

■ **Epi-Illuminators PM-LSD 2**

This pair of illuminators offer vertical illumination essential to macrophotography. The height of the illuminator is adjustable on the tall pillar, suitable to overstage or substage illumination. When used with the Trans-Illuminator Base X-DE, the Illuminator supplies

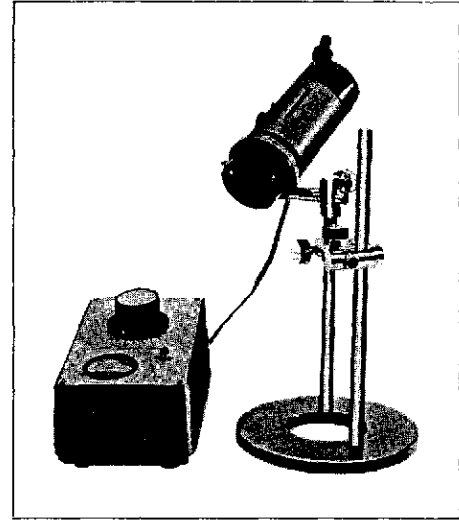

transmitted light. Focusing is adjustable by shifting the bulb filament. A 6V to 8V variable transformer is provided. Eight filters are available in various sizes, including color, black and white, neutral density, etc. for transparent or translucent subjects.



MACROPHOTOGRAPHY UNITS

■ Trans-Illuminator LSD

This unit is a universal type trans-illuminator for use with the X-DE Trans-Illuminator Base. When the Lieberkuhn Reflector is added, vertical light is also available. A 6V, 30W bulb is built-in. The condenser travels 18mm by rack and pinion for converging, diverging and

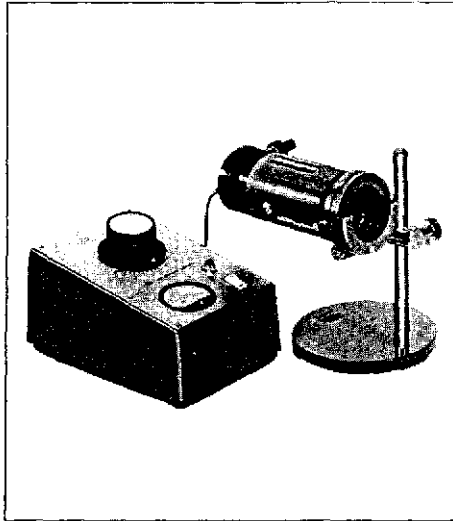

parallel adjustments of light. Complete with transformer and square filter 60 x 45C. Provided with a filter holder for attachment of various OLYMPUS filters, round and square.

- **Stage Glasses** (Clear, frosted-&-black)
- **Stage Plate 45** (metal disc, black)
- **Stage Plate 28** (metal disc, black)
- **Glass Shade Stage Plate**

Supplied with two stage inserts; compatible with the Lieberkuhn Reflector. The center port accepts the stage insert on which a subject is placed.

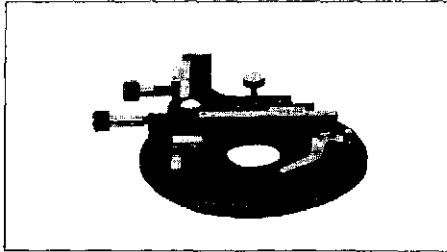

■ Mechanical Stage FM

This stage is used to mount subjects on the 28mm stage plate. The subject travels vertically and horizontally by precise adjustments with vernier.

■ Spare Bulb 6V 5A TB-1

(for PM-LSD2 & LSD)

■ Spare Bulb 6V 5A TP-1 (for PMT-35)

■ Adapter PM-EA

Accepts the photosensitive probe of the EMM-7 Exposure Meter in conjunction with the PMT-35 or Auto Bellows.

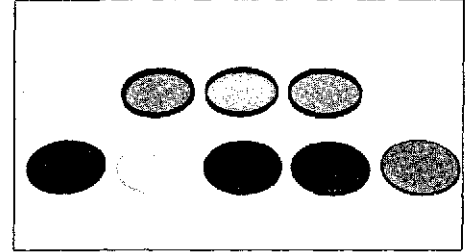
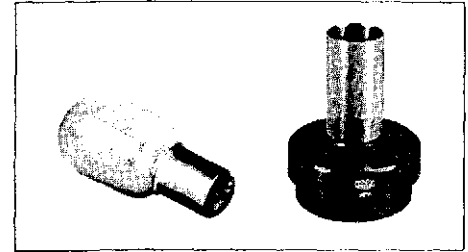

■ Filters

Round filters are used with the PM-LSD2 and LSD, while square filters used with the LSD only. They are color temperature compensation, monochromatic, neutral density, diffusion, heat absorbing and interference filters.

■ **Lieberkuhn Reflector PM-LM20**

■ **Lieberkuhn Reflector PM-LM38**

These Reflectors are available for use with the 20mm and 38mm Macro Lenses. When used with the LSD Trans-Illuminator, they make it possible to take photographs with excellent penetration and lack of shadows.

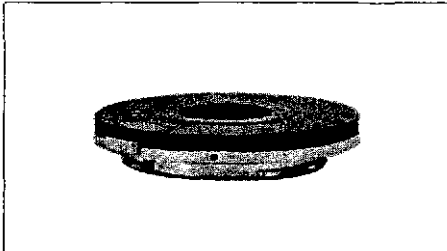
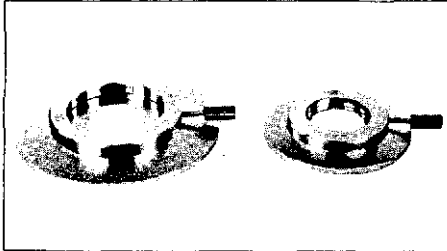

■ **Objective Lens Mount PM-MTob**

This objective mount enables you to mount the Zuiko Macro 20mm and 38mm to the Auto Bellows. It also connects to the Light Shield Tube PM-SDM.

■ **Incident Illuminator Mirror Housings PM-EL80, PM-EL38 and PM-EL20**

These units are used with OLYMPUS Macro Lenses in conjunction with the Epi-Illuminator PM-LSD2 or Macro-photographic Equipment PMT-35 to illuminate macrophotographic objects with incident light. They are effective

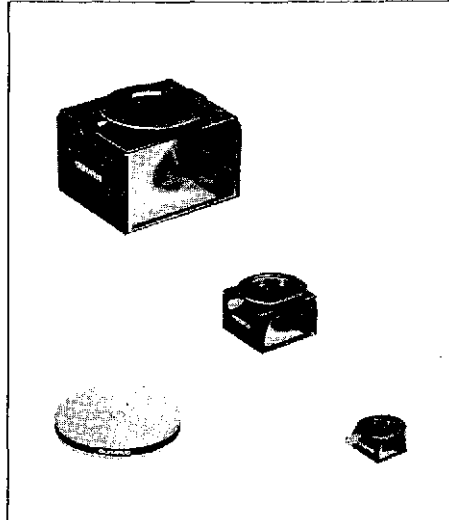

when shadowless pictures are desired.

■ **Centering Mirror PM-ELCS**

For use with these PM-EL units for accurate centration or for use with the Trans-Illuminator Base X-DE.

■ **Macrophotographic Unit PMT-35**

The PMT-35 is a complete macrophotographic system for OM System photo work providing image magnification from 0.45x to 16.5x with transmitted or reflected light as desired. The standard set consists of 26 out of the 46 high precision units of OLYMPUS macro-

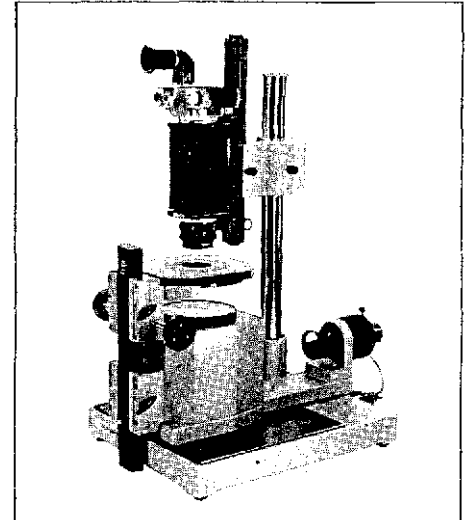

photo equipment. The OM Mount Photomicro Adapter H connects the OM Body to the PMT-35.



PHOTOMICROGRAPHY GROUP

When the photographic magnification desired exceeds 10x magnification, it becomes more difficult for the macro-photographic equipment alone to obtain excellent pictures. A sophisticated array of photomicrography accessories with a microscope as the central figure is required. The exciting vision of looking at the microscopic world through a microscope can be recorded by the OM-1.

OLYMPUS also has an outstanding reputation for manufacturing precision microscopes used by scientists throughout the world. Naturally, the OM System includes a variety of microscope adapters, rugged stands, a special shutter to prevent vibration at high magnification, and an automatic exposure mechanism, which solves the difficult problem of microscopic exposures.

The Photomicrography Group is designed to expand the photomicrographic world not only into the scientific realm, but also into the creative sphere, so that the photographer's achievements under the microscope can be easily and accurately recorded with his OM-1.

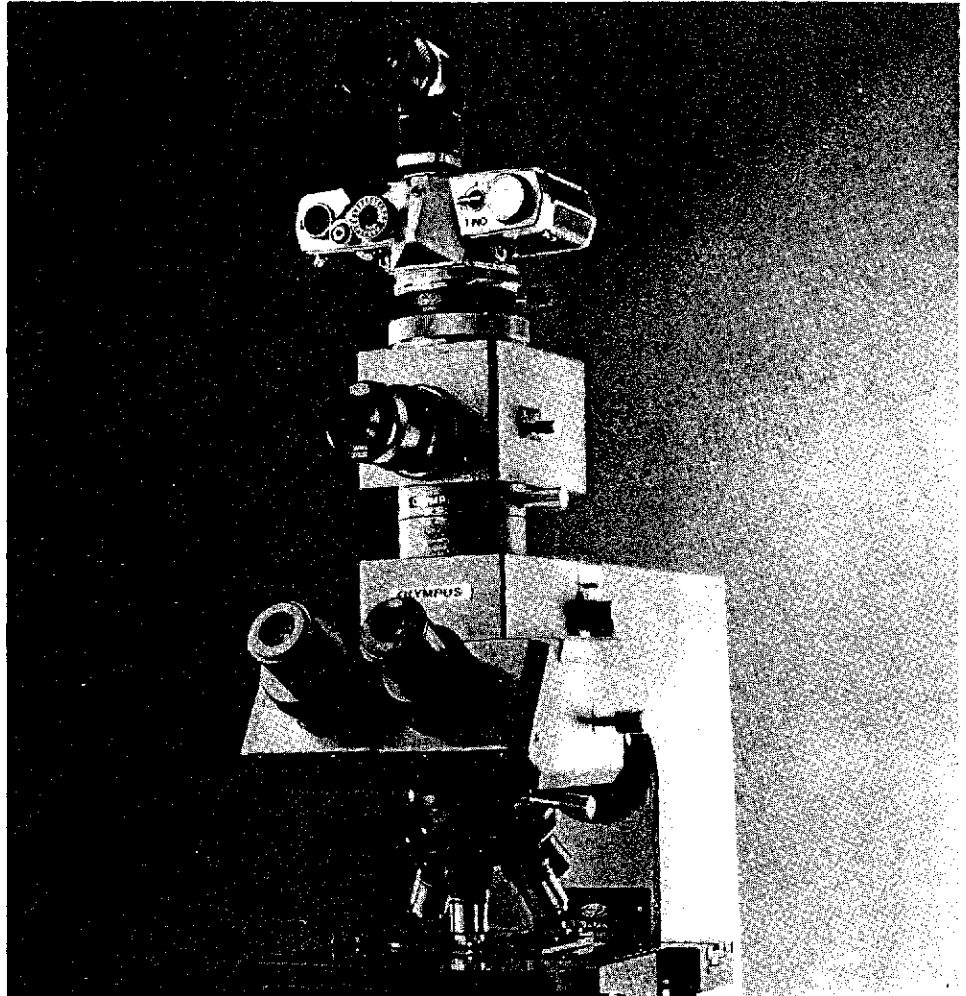

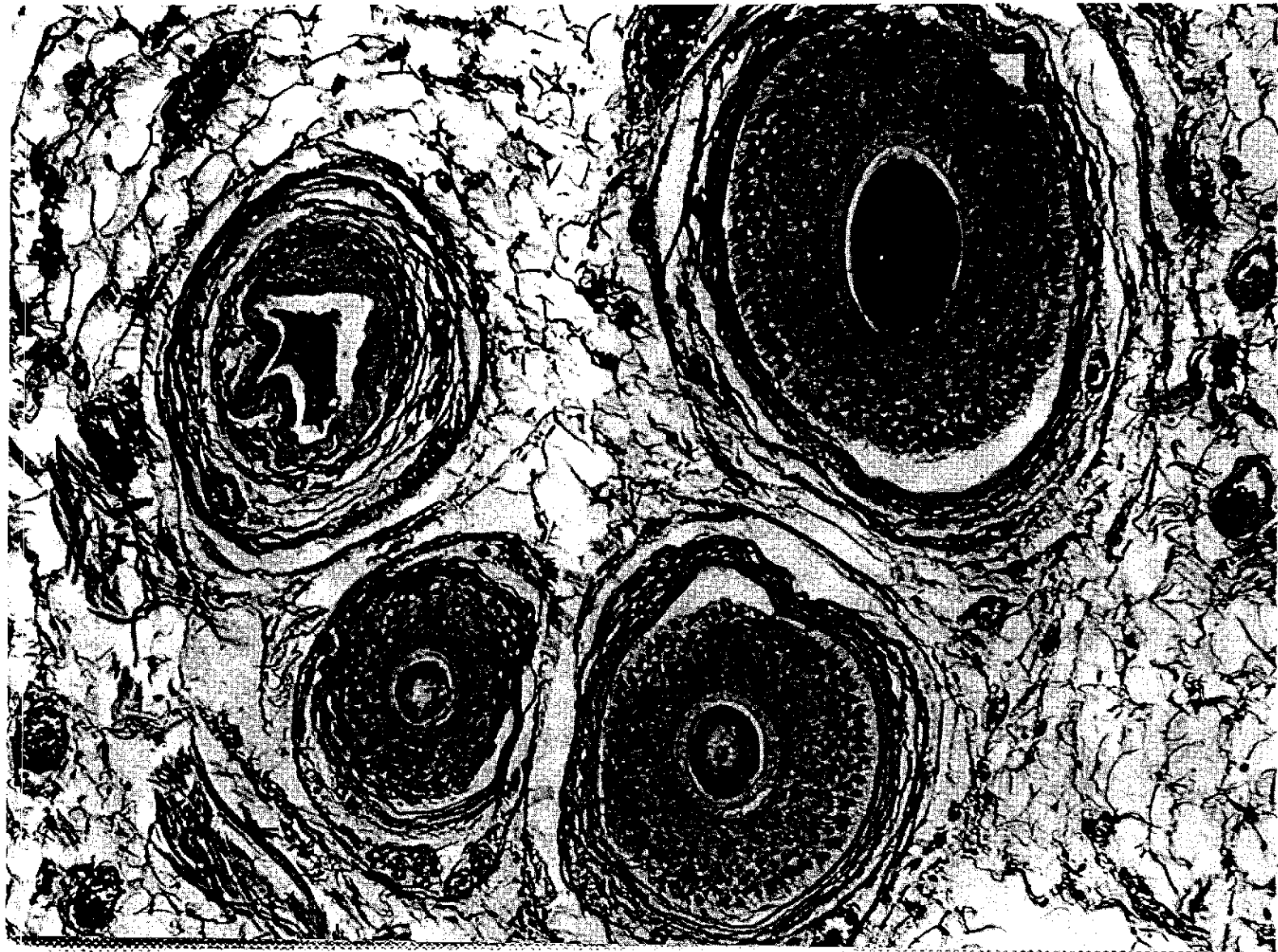
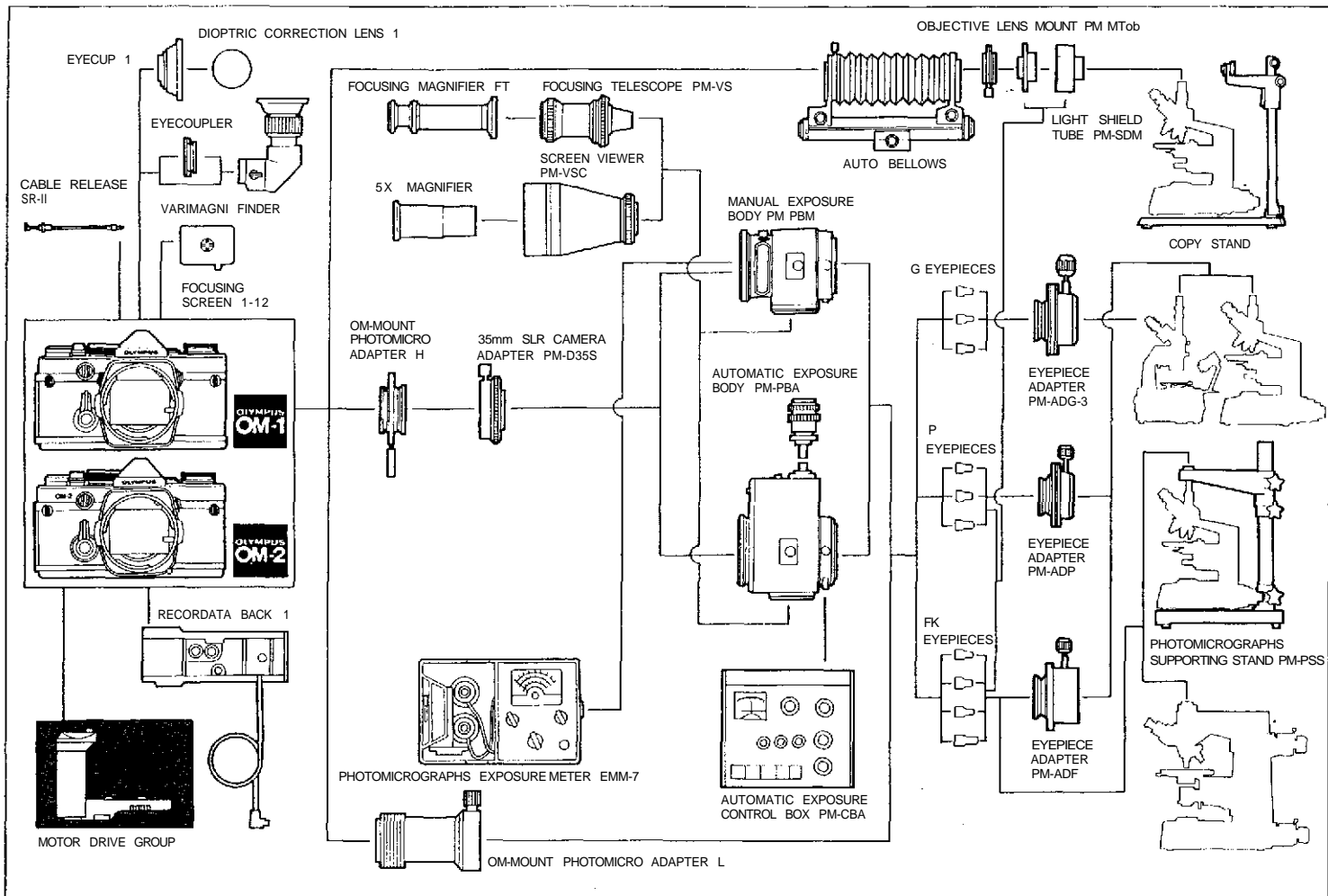



CHART OF PHOTOMICROGRAPHY GROUP





PHOTOMICROGRAPHY UNITS

■ OM-Mount Photomicro Adapter L

Connects the OM Body to the microscope for low power magnification.

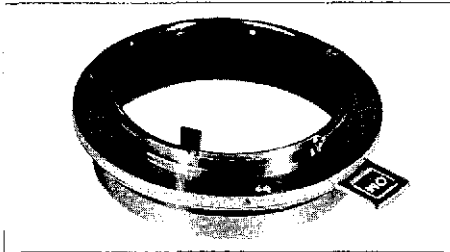
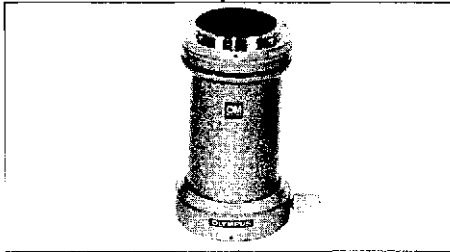

■ OM-Mount Photomicro Adapter H

Connects the OM Body to the Photomicrographic System PM-10, automatic or manual, or Macrophotographic Unit PMT-35 for high power magnification.

■ 35mm SLR Camera Adapter PM-D35S

Used with OM-Mount Photomicro Adapter H to attach the OM Body to the PM-PBA or PM-PBM.

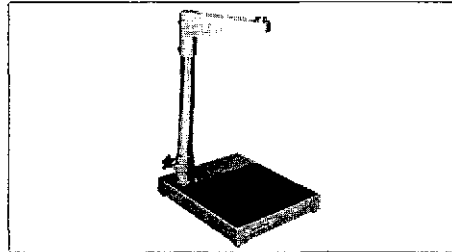
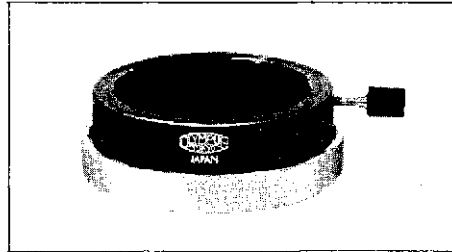

■ Photomicrographic Supporting Stand PM-PSS

This unit is a massive stand to virtually end the major cause of lost photomicrographs at high magnification . . . vibration. Supports the entire camera weight, isolating it from the microscope.

■ Eyepiece Adapter PM-ADG-3, PM-ADP, PM-ADF

Used to connect a microscope to the OM-Mount Photomicro Adapter L, PM-PBA or PM-PBM. Each Adapter designates OLYMPUS microscope eyepieces as follows: PM-ADG-3 for G eyepieces, PM-ADP for P eyepieces and PM-ADF for FK photo eyepieces.

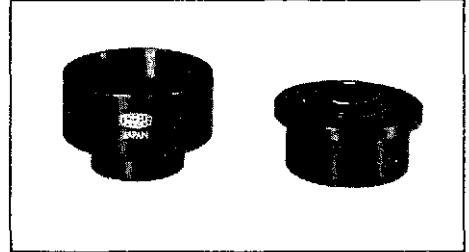
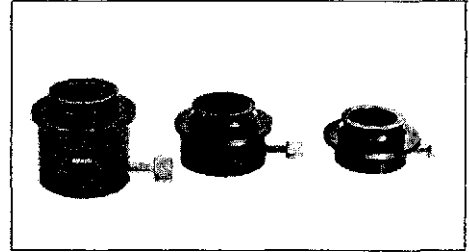

■ Light Shield Tube PM-SDM

Designed for use with the Auto Bellows and Objective Lens Mount PM-MTob. Assures excellent images when used with FK photo eyepieces at the bellows length of 111mm, free of shutter vibration.



PHOTOMICROGRAPHY UNITS

■ Auto-Photomicrographic System

PM-10-A

Consists of 17 units, including the PM-PBA, PM-CBA, etc.

● Automatic Exposure Body PM-PBA

Automatically determines accurate exposure time, compensating for reciprocity failure.

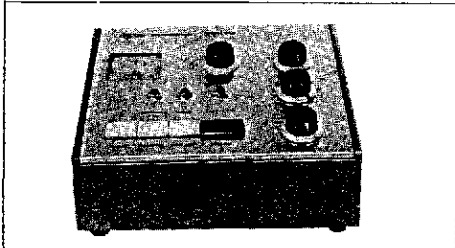
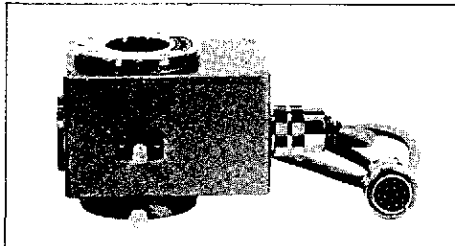

● Automatic Exposure Control Box PM-CBA

Used with the Automatic Exposure Body PM-PBA, to regulate color temperatures control. Eight filters provided.

■ Manual Photomicrographic System PM-10-M

This is a popular manual version of the PM-10, consisting of 8 units.

● Manual Exposure Body PM-PBM

A special shutter release button is integrated to eliminate shutter vibration.

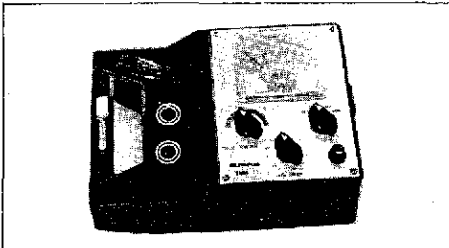
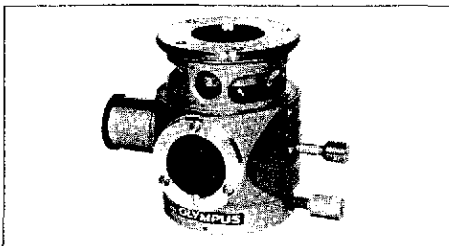

■ Photomicrographic Exposure Meter EMM-7

The EMM-7 assures accurate control of both exposure and color temperature in photomicrography. Provided with exposure and color temperature probes, color-compensating filters.

■ Screen Viewer PM-VSC

For use with objectives lower than 4x power. A hood is provided to reduce extraneous light on the viewing screen.

■ 5X Magnifier

For use with the Screen Viewer for magnifying any part of the subject area and focusing accurately.

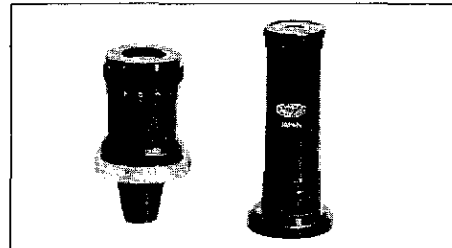

● Focusing Telescope PM-VS

For use with objectives 4x and up in conjunction with the Automatic or Manual Exposure Body.

■ Focusing Magnifier FT

Used to magnify the image obtained by the Focusing Telescope.



CHART OF PHOTOGRAPHIC RANGES

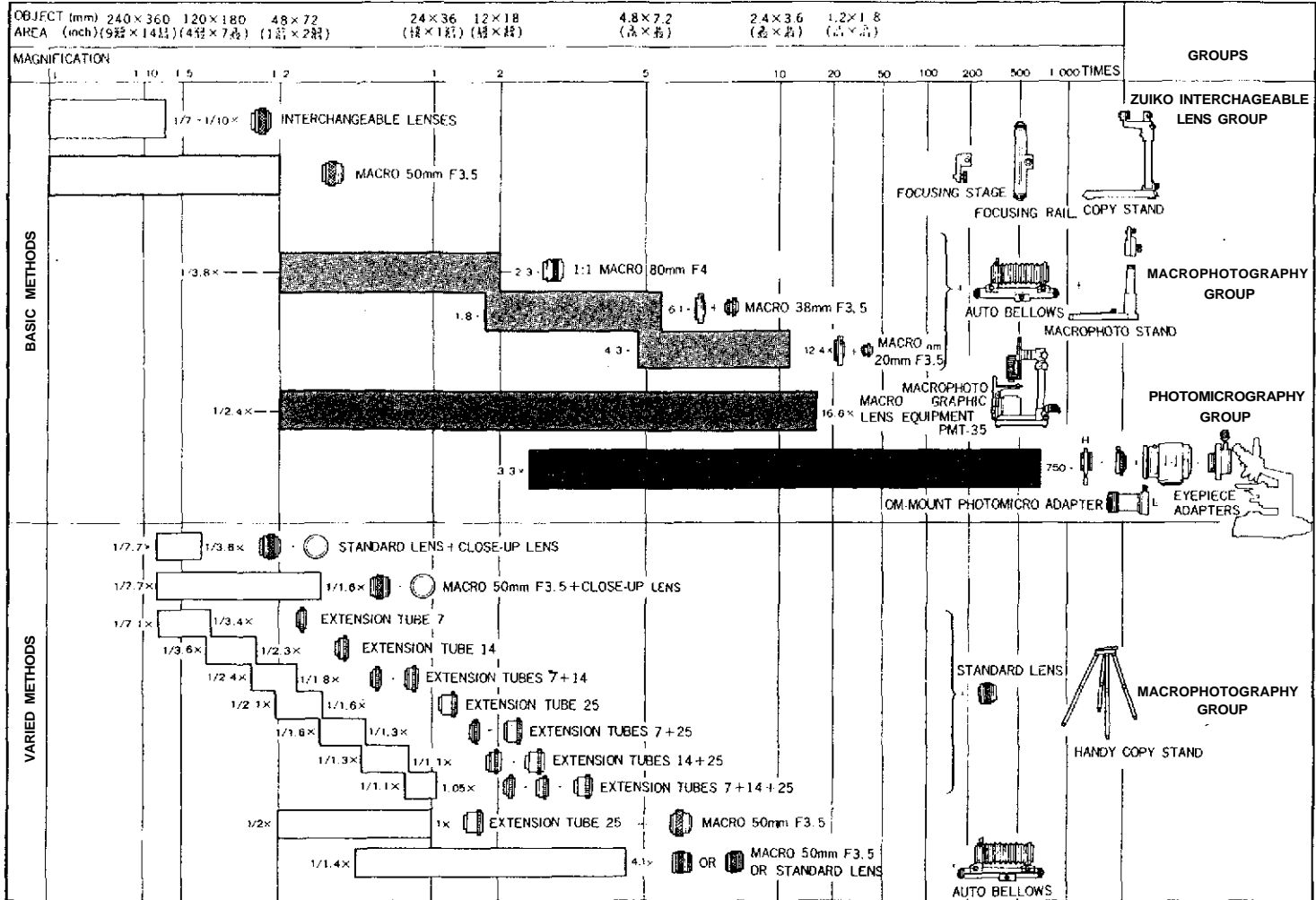



PHOTOTECHNICAL GROUP

As a leading manufacturer of optical instruments, OLYMPUS has produced a wide variety of microscopes, medical and measuring instruments that have been making a major contribution in many fields of modern life. They are also vital elements in the OM System which many scientists can use to successfully document their achievements in photographs.

OLYMPUS products include fiber-scopes that are capable of visualizing the internal view of the human organs and taking photographs for diagnosis and treatment of diseases; operation microscopes for microsurgery; astronomy telescope adapter to explore the mysteries of space and stars — all capable of attachment to the OM Body.

For OLYMPUS Pen F and FT enthusiasts, a mount adapter is available for connection of these cameras to the OM System Interchangeable Lenses and other units. Another outstanding advantage the OM System features is the Recordata Back that is interchangeable with the OM Body camera back. Once in place, the Back imprints numbers directly on the picture when the exposure is made.

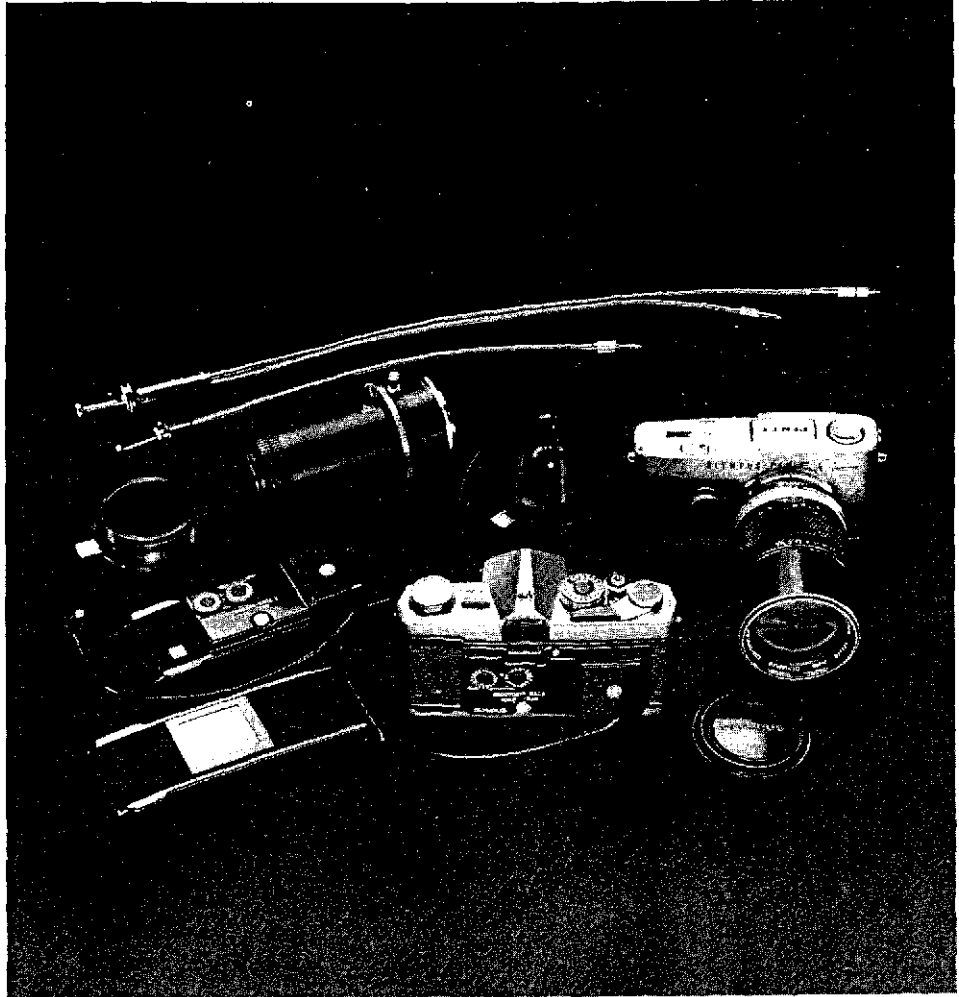



8

16



CHART OF PHOTOTECHNICAL GROUP

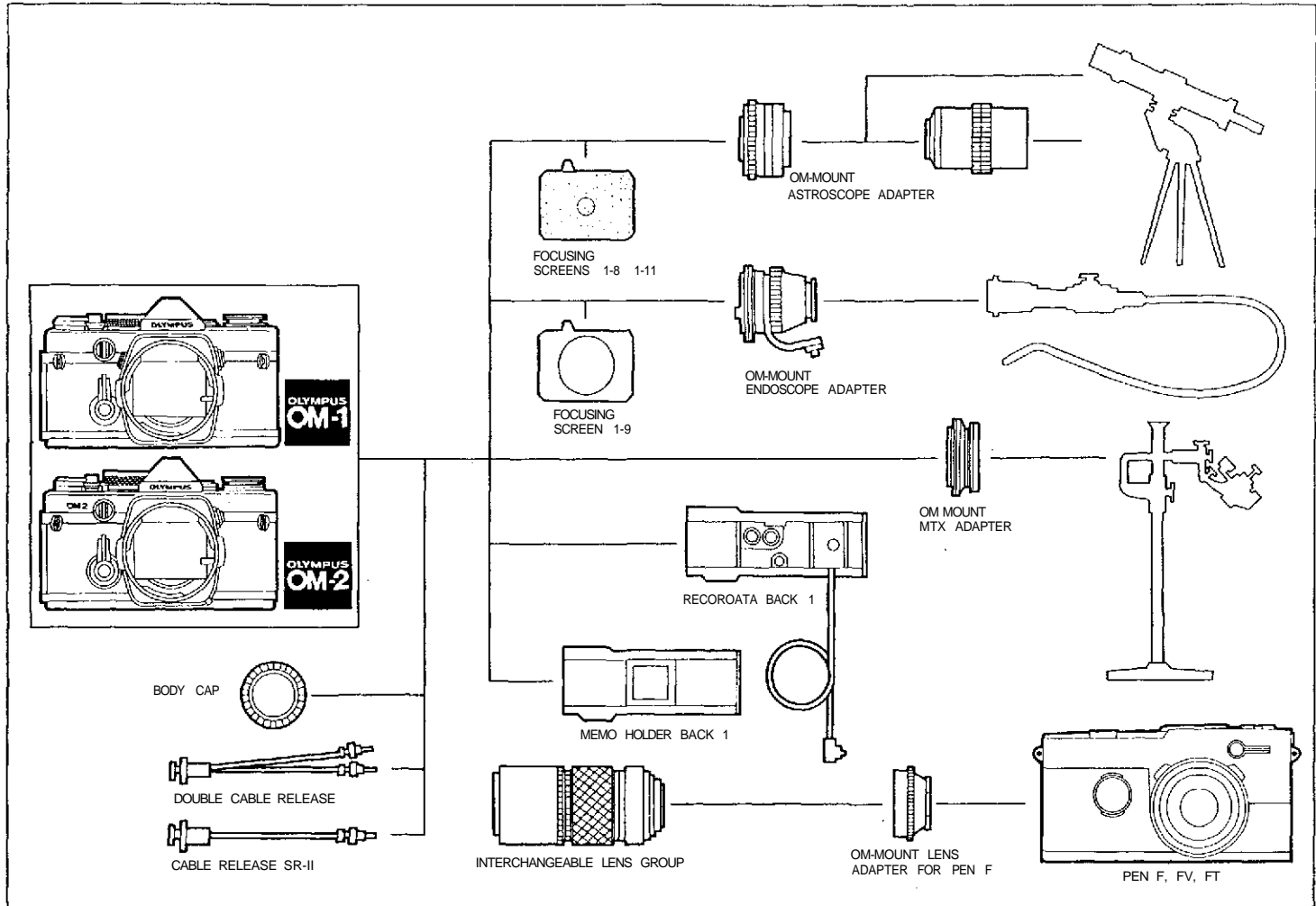



PHOTOTECHNICAL UNITS

■ Recordata Back 1

Used as a replacement camera back of the OM Body, the Recordata Back makes provision to imprint data such as date, numbers, etc. directly on the pictures. Provided with a built-in light emitting diode powered by three 1.5V silver oxide batteries. It measures only

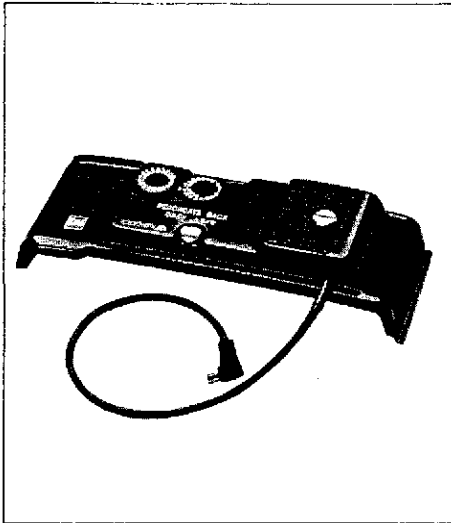

28mm (1.1") in thickness, weighing 95g (3.4 oz.) without batteries.

■ OM-Mount Astroscope Adapter

Permits astrophotography by the OM Body attached to a telescope by means of the 36.5mm diam., pitch 1mm and pitch 0.75mm threads. It enables direct objective photography and high magnification photography through the telescope eyepiece.

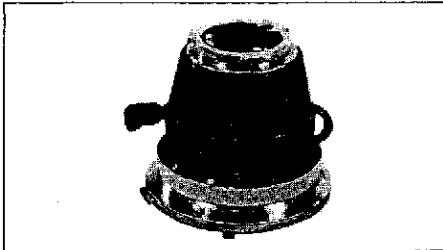
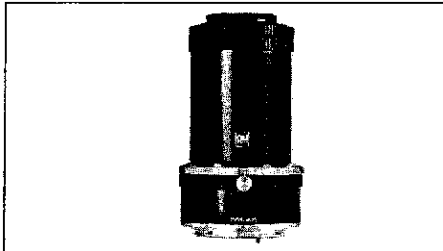

■ OM-Mount Endoscope Adapter

Used for mounting the OM Body to the OLYMPUS fiberscopes except the gastrocameras. The clear field type Focusing Screen 1-9 is recommended for use with this adapter.

■ OM-Mount MTX Adapter

Its bayonet mount facilitates mounting the OM Body on the OLYMPUS Operation Microscope MTX.

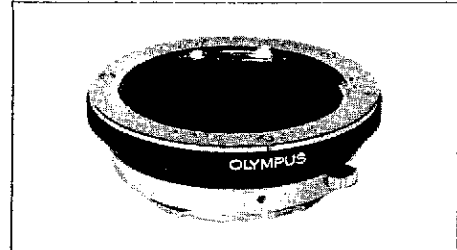
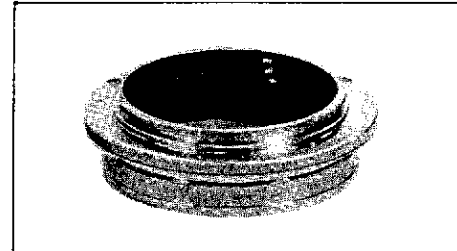

■ OM-Mount Lens Adapter for Pen F

Connects the OLYMPUS PEN F, FT and FV cameras to the OM System Interchangeable Lenses and other units.

■ Double Cable Release

Used with the Auto Bellows.

■ Cable Release SR-II



CASE GROUP

However ruggedly constructed, the camera is essentially a precision instrument and should be kept away from abrupt motions as much as possible. On the other hand, various units require rapid changing in actual use. Replacement of interchangeable lenses, for example, may have to be carried out quickly to meet changing photographic conditions.

The outstanding versatility of a true system camera can be enhanced if it is easy to operate and carry. With a properly designed case, both carrying and using your equipment becomes more convenient.

The OM System Case Group includes a large variety of cases so that the OM Body and other units may fit properly. They are compartment cases, specially made of tough synthetic leather, and designed to perfectly accommodate the photographic units. The adjustable partitions can be rearranged in the case to suit the photographer's individual requirements. Soft, hard and semi-hard cases to fit the OM Body and standard lenses, with a choice of carrying straps, are also available.



CASE UNITS

- **Hard Case for OM Body with F1.8 or F1.4**
- **Hard Case for OM Body with F1.2**
Accommodates the OM Body with respective standard lens.
- **Semi-Hard Case for OM Body with F1.8 or F1.4**

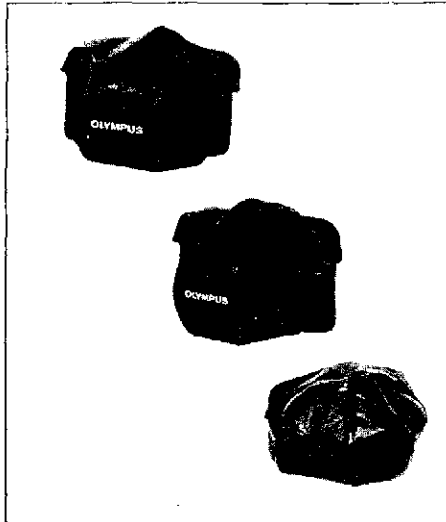

- **Semi-Hard Case for OM Body with F1.2**
- **Soft Case for OM Body with F1.8 or F1.4**
Accommodates the OM Body with F1.8 or F1.4 standard lens, and the Recordata Back 1.
- **Soft Case for OM Body with F1.2**

- **Lens Pouch 100**

Made of fine leather to contain a single lens 100mm or smaller.

- **Lens Pouch 200**

A fine leather container for a telephoto lens 200mm, zoom lens, or smaller. The main body of the Quick Auto 310 can also be contained.

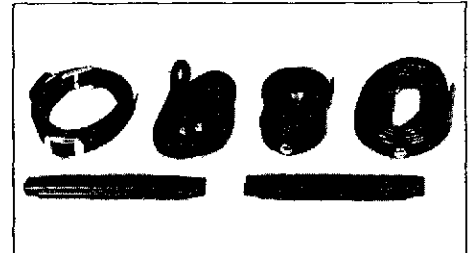

- **Leatherette Shoulder Strap with Shoulder Pad 1**
- **Leather Shoulder Strap with Shoulder Pad 2**
- **Flat Braid Shoulder Strap**
- **Round Braid Shoulder Strap**

■ **Compartment Case S**

A hard shoulder case with two adjustable partitions. Holds OM Body, two interchangeable lenses and filters; or Quick Auto 310, Bounce Grip and OM Body can be contained.

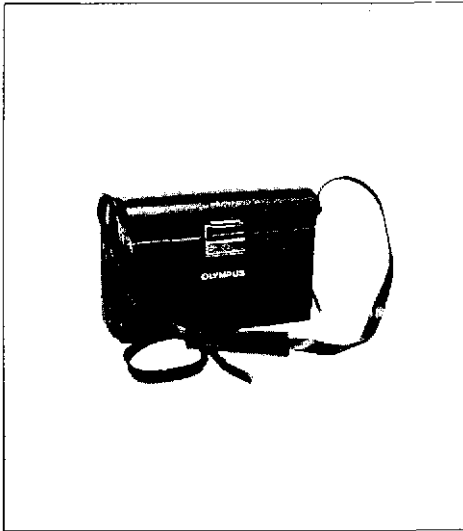

■ **Compartment Case M**

A soft shoulder case with partitions and two pockets. Holds OM Body, three interchangeable lenses and various auxiliary equipment including electronic flash. Straps for carrying tripod.

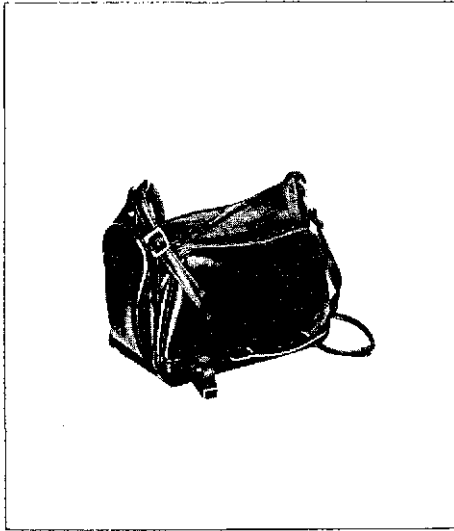

■ **Compartment Case L**

A hard shoulder or hand-carried case with two adjustable partitions. Holds two OM Bodies, two interchangeable lenses (including 300mm telephoto lens), electronic flash, large format camera, and other equipment.

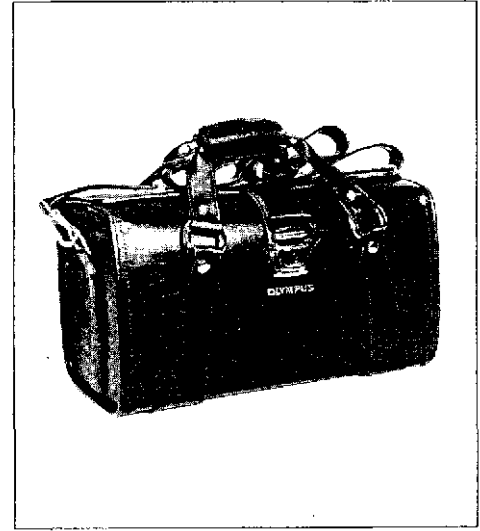

■ **Partitioned Insert**

When inserted into the Compartment Case L, this unit supports the assembly of the Motor Drive Units. The 250 Film Back 1 and interchangeable lenses can be contained together with the OM Body.

COMPARTMENT CASE S

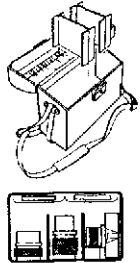
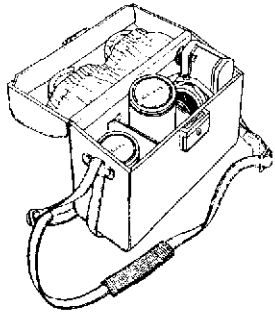

COMPARTMENT CASE M

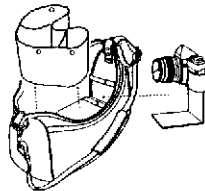
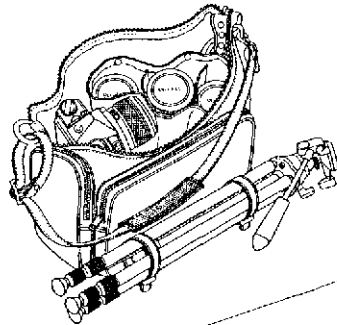

COMPARTMENT CASE L

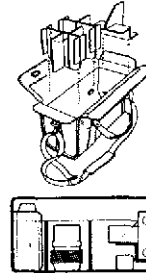
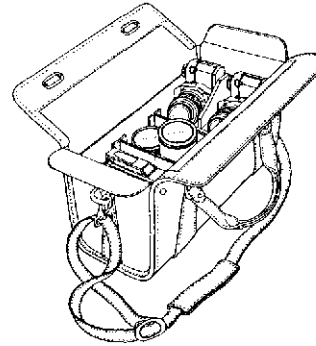

**MOTOR DRIVE
PARTITIONED INSERT**

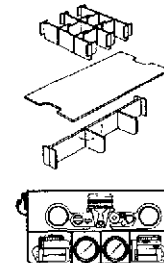
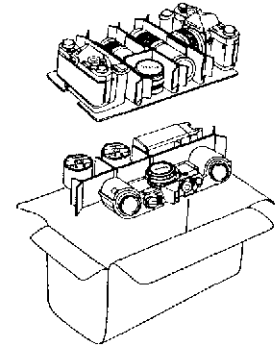

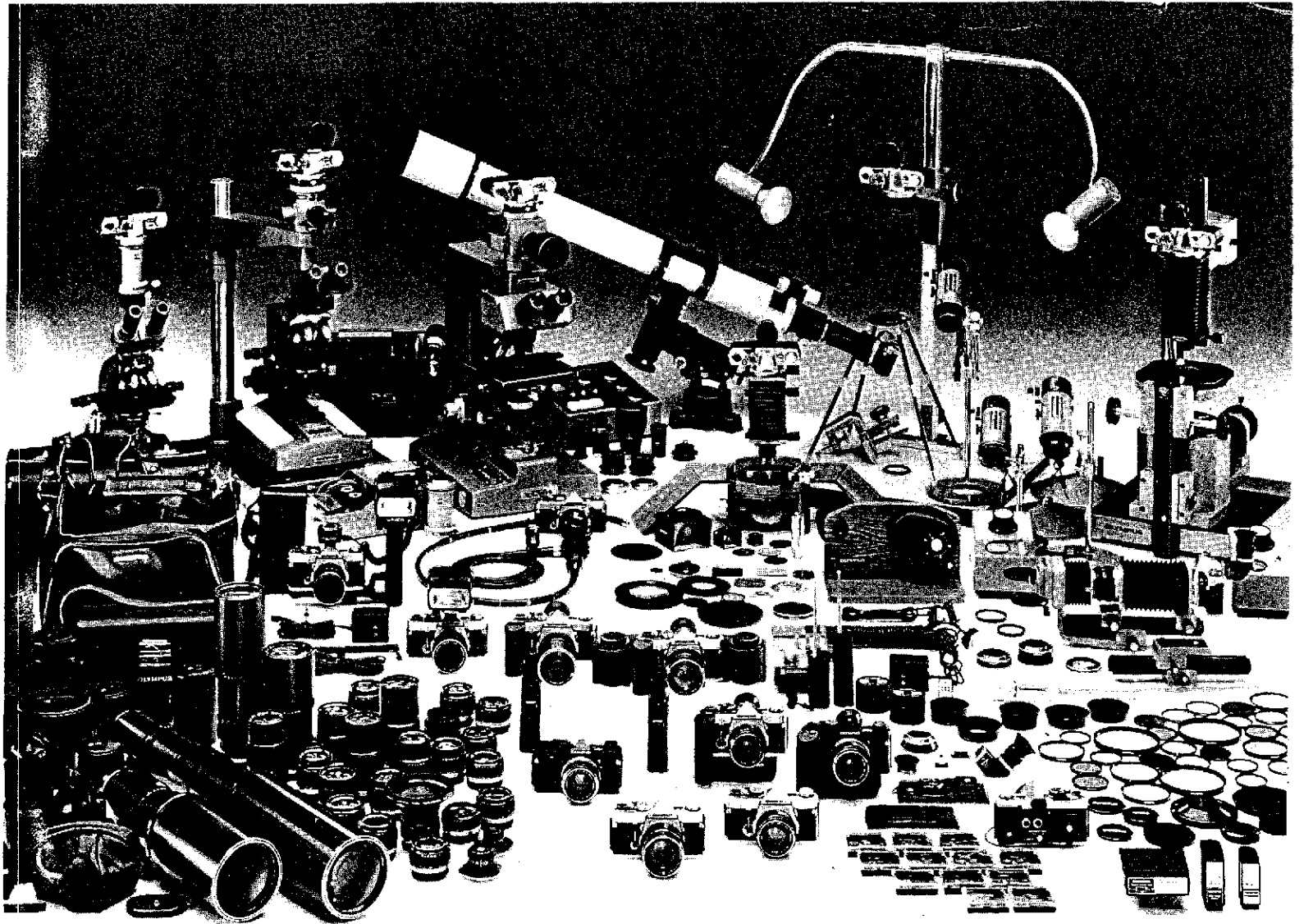



OLYMPUS

OLYMPUS OPTICAL CO., LTD.

43-2 Hatagaya 2-chome, Shibuya-ku, Tokyo, Japan Tel. 03-377-2111

OLYMPUS CAMERA CORPORATION

145 Crossways Park, West, Woodbury, New York 11797, U.S.A. Tel. 516-364-3000

OLYMPUS OPTICAL CO. (EUROPA) GMBH.

2 Hamburg 1, Steindamm 105, West Germany Tel. 040-248021

OLYMPUS OPTICAL CO. (U.K.) LTD.

2-8 Honduras Street, London EC1Y 0TX, England Tel. 01-253 2772