



OLYMPUS

OM-2S
PROGRAM

INSTRUCTIONS

Please read this instruction manual carefully before using the camera, so that you may be sure of taking correctly exposed, properly focused and beautifully composed pictures every time you use your OM-2S PROGRAM. We sincerely wish that your OM-2S PROGRAM will become a source of unending satisfaction for you.

Note: All the components of the Olympus OM-2S PROGRAM are carefully designed and their production and assembly is strictly controlled to enhance the unmatched performance of the system. If any interchangeable lenses, flashes, or accessories other than Olympus products are used, Olympus cannot be responsible for poor results or damage of the OM-2S PROGRAM.

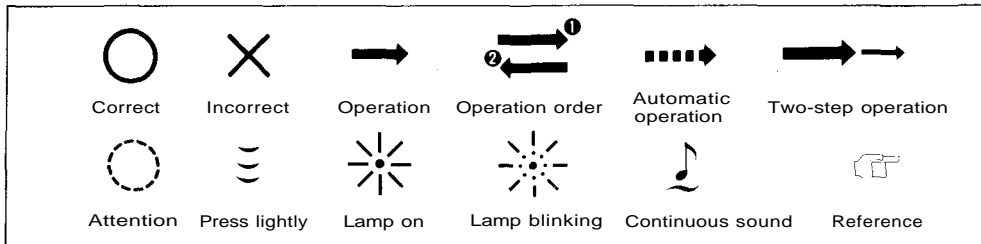

TABLE OF CONTENTS

< Preparations before Taking Pictures >		< OM System >	
•Mounting the Lens	4	•Changing the Focusing Screen	35
• Detaching the Lens	5	•Changing the Camera Back	36
•Inserting the Batteries	6	•Attaching the Electronic Flash	37
•Checking the Batteries	7	•Attaching the Motor Drive or Winder	39
•Loading the Film	8		
•Setting the Exposure Counter to "1"	11	•Handling Care	41
•Setting the ISO Film Speed	12	•Storage Care	42
< Basic Shooting Mode >		•Battery Precaution	42
• Programmed Exposure on TTL Direct		•Description of Controls	43
"OTF" Light Metering	14	•Specifications	47
•Rewinding the Film	17		
•TTL Direct "OTF" Light Metering	19		
• What to Do when Overexposure			
Warning Appears?	22		
• What to Do when Shutter Speed			
is too Slow?	22		
< Sophisticated Shooting Mode >			
•How to Use the MANUAL/SPOT	24		
•Exposure Compensation	27		
• How to Shoot when the Batteries			
are Exhausted	27		
< Other Operations >			
•The Use of the Self-Timer	30		
•Using the Viewfinder Illuminator	31		
•How to Turn off the Beeper	32		
•Attaching the Grip	32		

OM-2S

PROGRAM

< Preparations before Taking Pictures >



Remove the body and rear lens caps.



Remove the front lens cap. (Press in the mount tabs on the edges of the lens cap parallel with "OLYMPUS").

Detaching the Lens

3



Align the red dots and rotate the lens clockwise until it locks.



Press the lens release button and turn the lens counter-clockwise.

Inserting the Batteries



Remove the battery cover.



Wipe battery surfaces clean. Make sure that + signs are facing upwards.

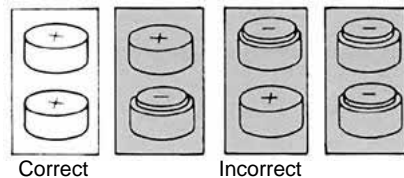
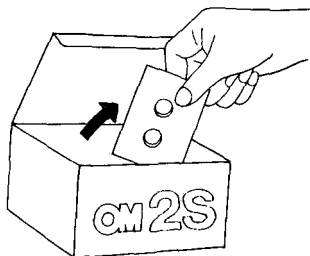

SR44 (LR44) ✗

Checking the Batteries

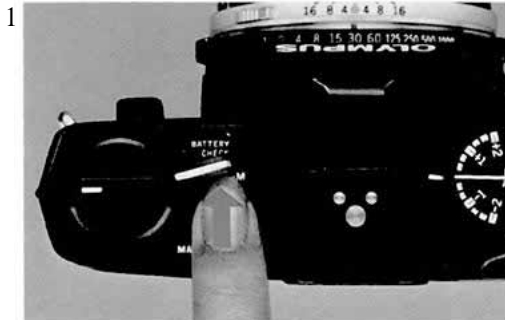

Press the mode selector lever to the "BATTERY CHECK" position.

* Make sure that the shutter speed ring is not set at 1/60 sec. or B (in red).

** Be sure to make battery check after replacing batteries.

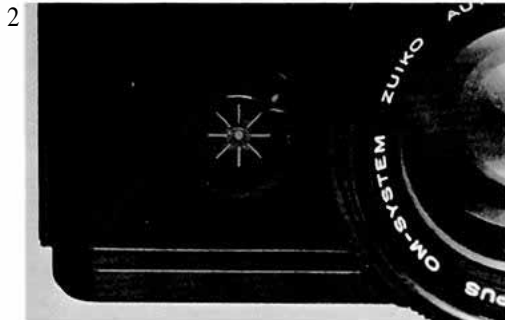

The audible and visual signals will tell you that the battery voltage is sufficient.

If these signals are emitted intermittently, it means that the batteries are almost worn out. Replace them with new ones as soon as possible.

Loading the Film

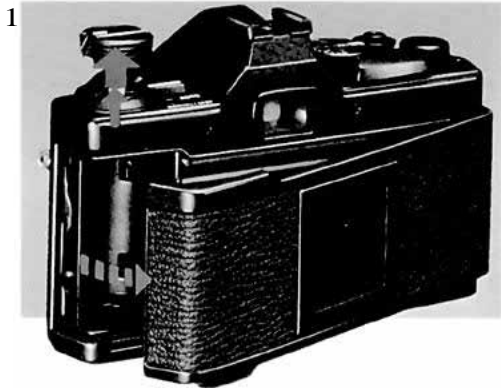

Pull up on the rewind knob to open the camera back.

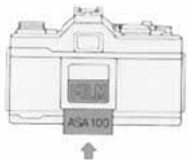

Tear off the top of the film box and insert it into the memo holder. It will remind you which film you are using.

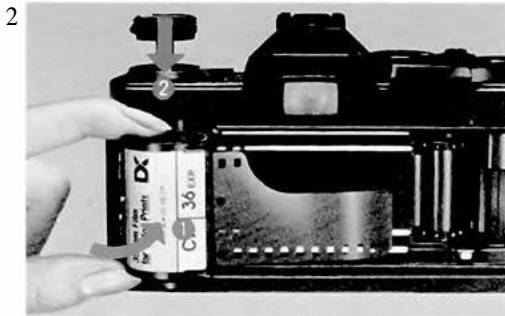

Place the film cartridge in the film chamber.



Always load film in the shade.

3

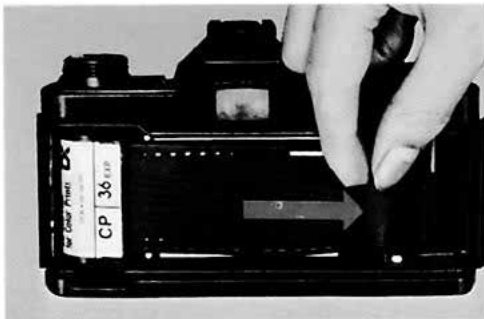

Insert the film leader into the take-up spool.

4

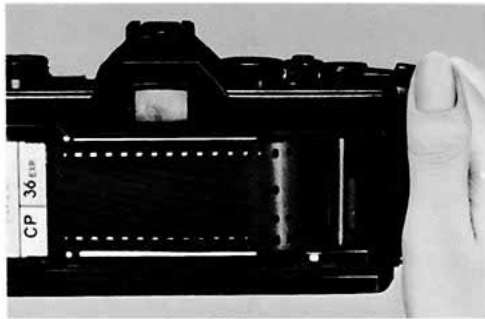

Wind the film once.

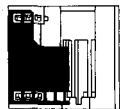

○ Correct

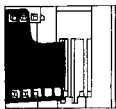

✗ Incorrect

5

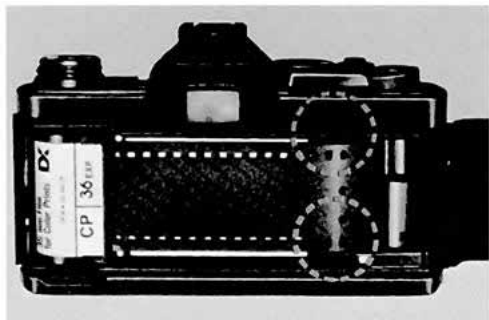

Continue to advance the film till sprockets are caught on both edges of the film.

6

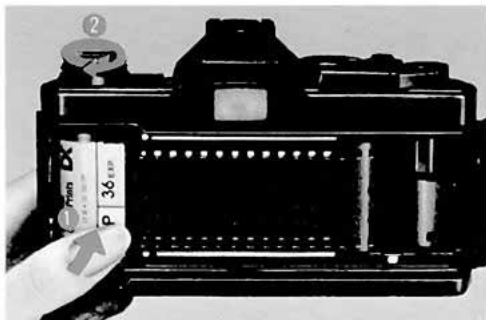

Take up the slack by turning the rewind crank clockwise.

Setting the Exposure Counter to "1"

7

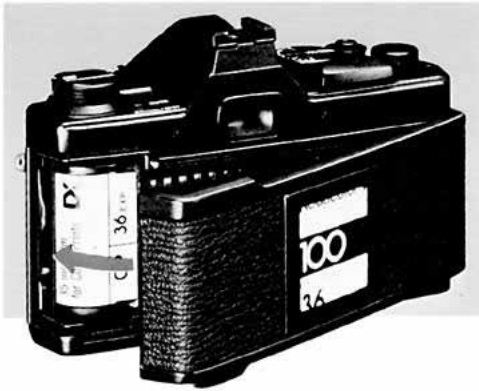

Close the camera back until it clicks into place.

1

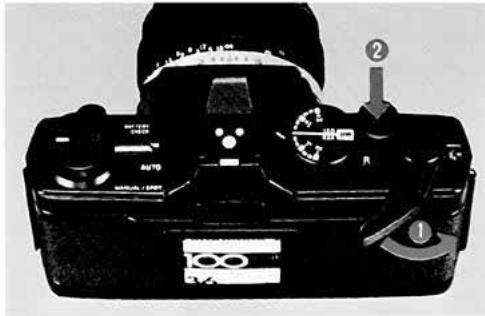

Face the camera toward light and take two blind shots.

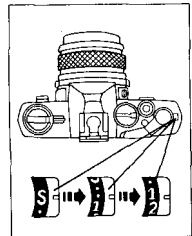
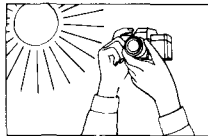

Setting the ISO Film Speed



Lift up the outer collar and rotate until the ISO speed appears in the window.



Align the exposure line (A) with the index (B)

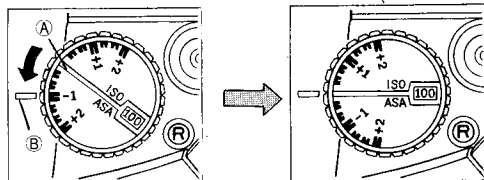
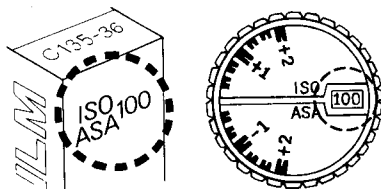

OM-2S

PROGRAM

< Basic Shooting Mode >

1

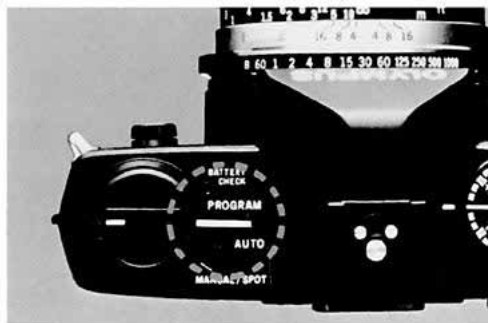

Set the mode selector lever to the "PROGRAM" position.

2



Set the lens to its minimum aperture.

3



Press the shutter release slightly to turn on the viewfinder.

(A built-in battery converter turns off the viewfinder display after 90 sec.)

4



Turn the focus ring in either direction until the subject is sharpest.

You can focus using any of the focusing aids: (A) Split-image rangefinder (B) Microprism collar (C) Surrounding ground glass.

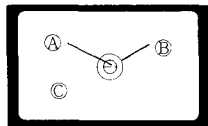

5

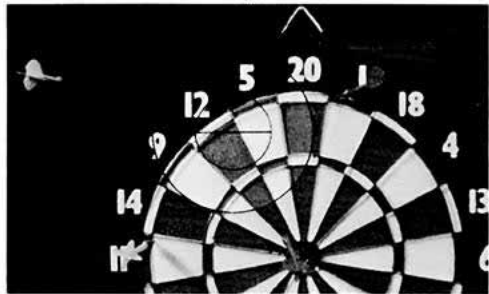
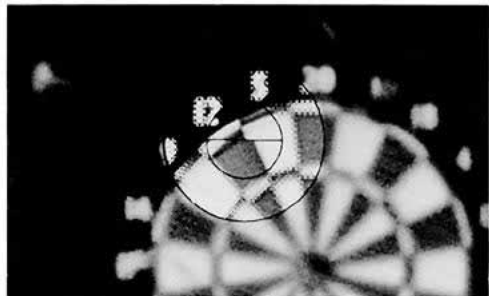

6



Press the shutter release to take the picture.

Rewinding the Film

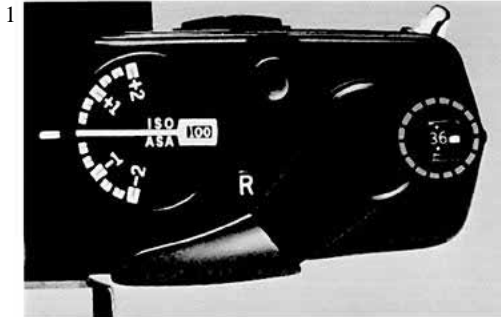

When the exposure counter indicates the end of your roll of film



Push the "R" button.

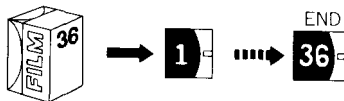

3

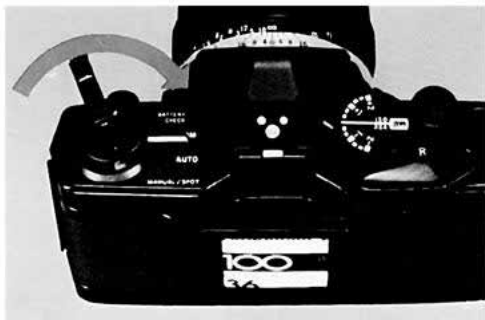

Fold out the rewind crank and wind it until the film tension is released.

4



Open the camera back by pulling up on the rewind knob and remove the film.

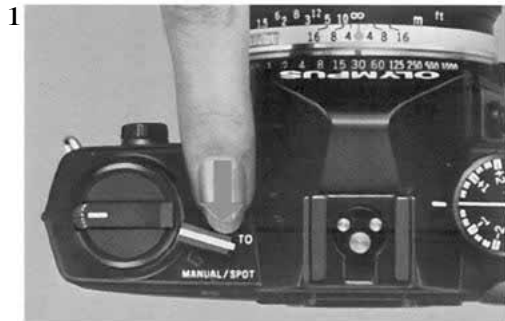

TTL Direct "OTF" Light Metering (Center-Weighted Averaging Method)



Set the mode selector lever to the "AUTO" position.



Set the aperture.

ISO/ASA 100			
F/stop	16	8	4
Weather			

3



Press the shutter release slightly to turn on the viewfinder.
(A built-in battery converter turns off the viewfinder display after 90 sec.)

4



Turn the focus ring in either direction until the subject is sharpest.

5

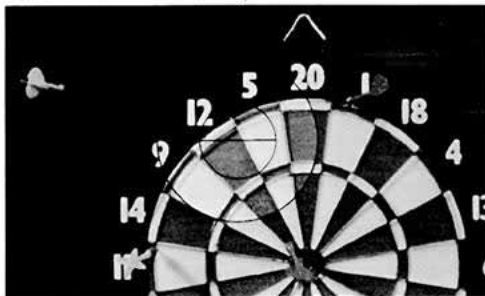
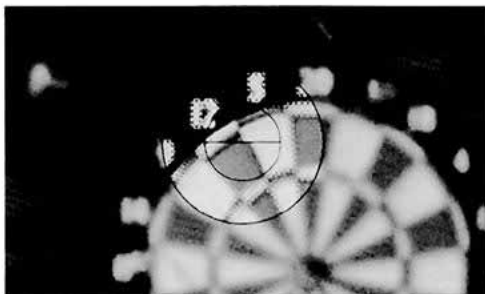

6



Press the shutter release to take the picture.

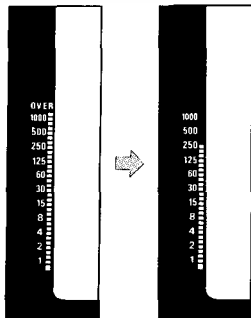

Turn the aperture ring to the higher F-numbers until the shutter speed is in the acceptable range.

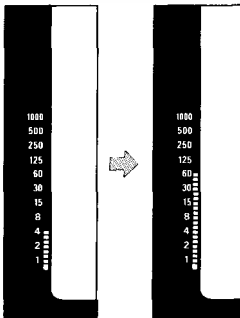

Turn the aperture ring to the lower F-numbers. This will speed up the shutter speed accordingly.

OM-2S

PROGRAM

< Sophisticated Shooting Mode >

1

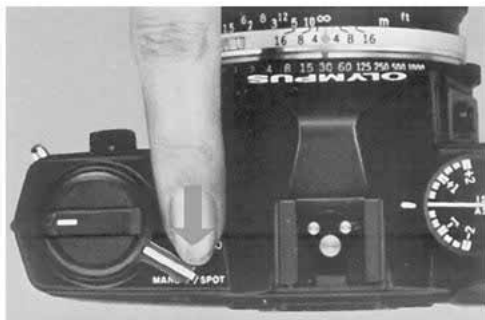

Set the mode selector lever to the "MANUAL SPOT" position.

2



Align the microprism area with the area you want to measure.

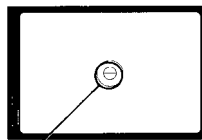

The spot metering range is outlined by the outer edge of the microprism.

3



Set the bar graph tip to the fixed point between the arrows by adjusting the aperture and/or shutter speed rings.



B-19

A-25

4



Frame the composition as you desire.

In **MANUAL/SPOT** mode, frame your subject after setting exposure.

5



Press the shutter release to take the picture.

6



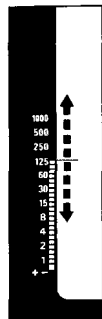
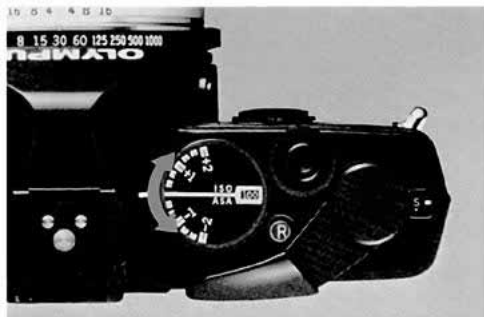

The exposure compensation dial provides ± 2 stops adjustment in 1/3 stop increments, " \pm " indicator lights when an exposure compensation is set. (After use, be sure to return the dial to the normal setting.)



While pressing the "B" Lock button, rotate the shutter ring to the red "60" position.

2

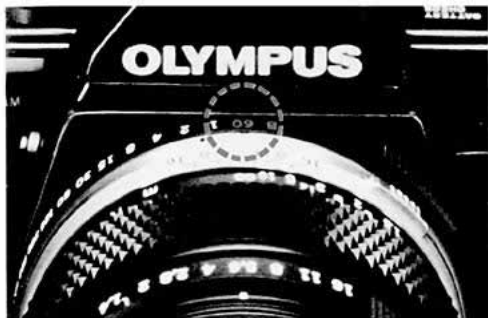

Mechanical shutter speed of 1/60 sec.

3



Press the shutter release to take the picture.

OM-2S

PROGRAM

< Other Operations >

1



With the camera facing you, lift up on the self-timer lever, and turn it counter-clockwise (as indicated).

2

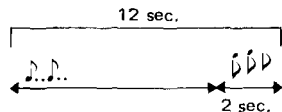

Press the shutter release to start the self-timer. The shutter will fire in 12 seconds. (After use, be sure to return the lever to the normal position.)

Using the Viewfinder Illuminator



Push the button if the viewfinder display is too dark to read.

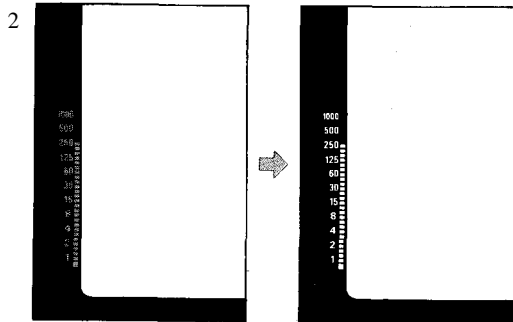

The illuminator is limited to 10 sec. or until you take the photograph, whichever comes first.

How to Turn Off the Beeper



If you want to turn off the audible signal, lift up the lever and push it clockwise around towards the lens.

Attaching the Grip



Camera Grip 1 (optional)

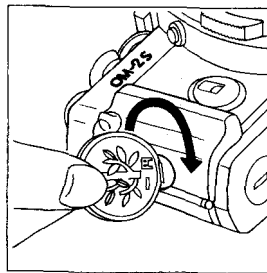

This grip provides a firm hand hold for increased steadiness.





Changing the Focusing Screen

1



Push up on the release catch, and the focusing screen and its frame will unlock.

2

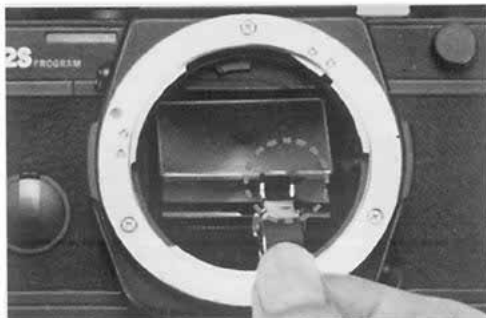

Carefully remove the focusing screen using the tools provided. Carefully place the new focusing screen in the frame, and push the frame up until it locks.



B-47

Changing the Camera Back



Recordata back 4 (optional)

Pull up on the rewind crank to open the camera back.

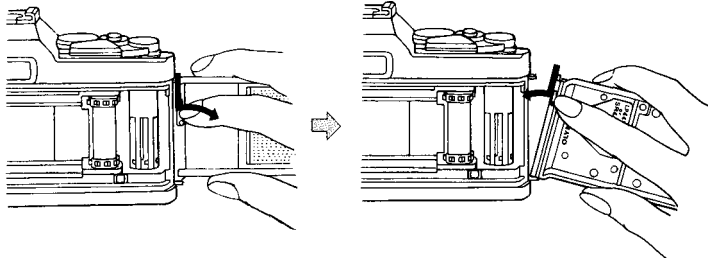

Attaching the Electronic Flash

1



Electronic Flash T45

2



TTL Auto Cord T2 (0.1m)

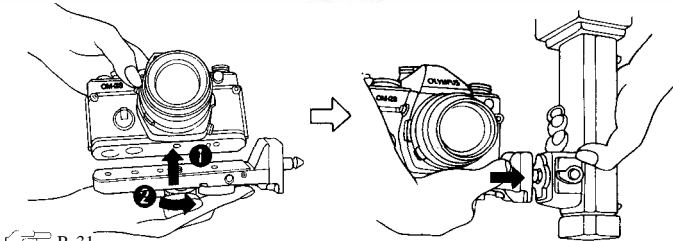

Connect the camera's TTL Auto Cord Socket to the base of the T45 with TTL Auto Cord T2 (0.1m, 0.15m).

B-31

1

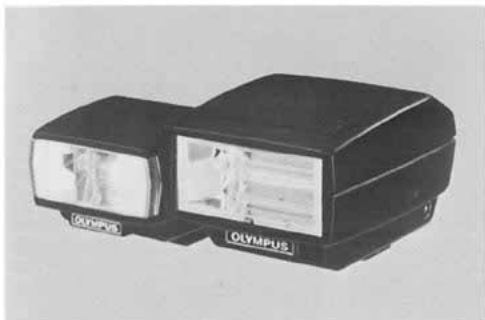

Electronic Flash T32 and T20

2



- ① Slide the flash into the hot shoe.
- ② Tighten the flash mount with the knurled ring.

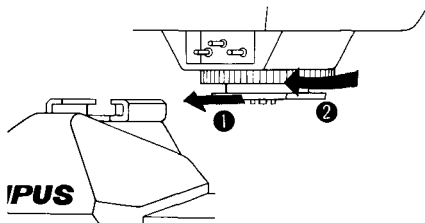

Attaching the Motor Drive or Winder



Motor Drive 2 / M.15V Ni-Cd Control Pack 2

① Remove the motor drive cover.

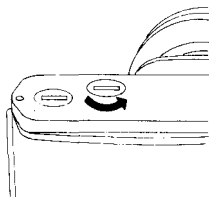

② Insert the fastening screw of the Motor Drive or Winder into the tripod socket of the camera.

③ Finger tighten until locked.

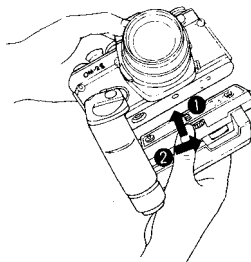

1



2



Winder 2

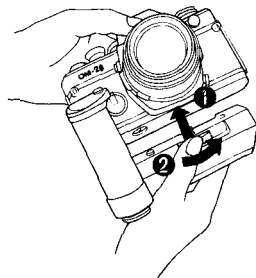
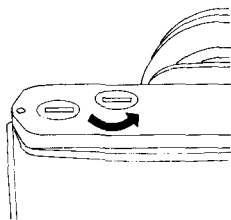

Handling Care

Take care in handling the camera.

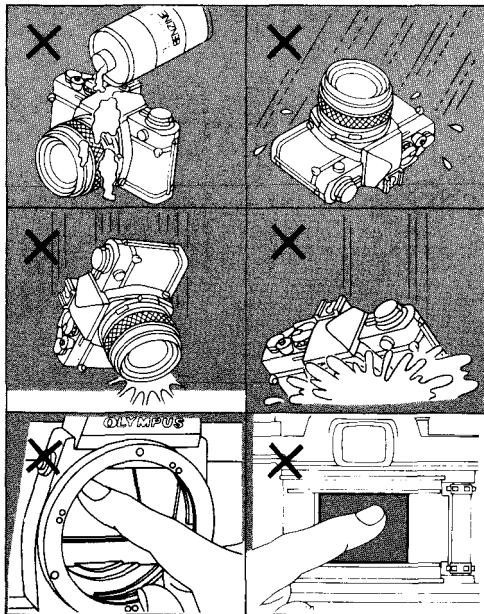

Do not apply excessive force.

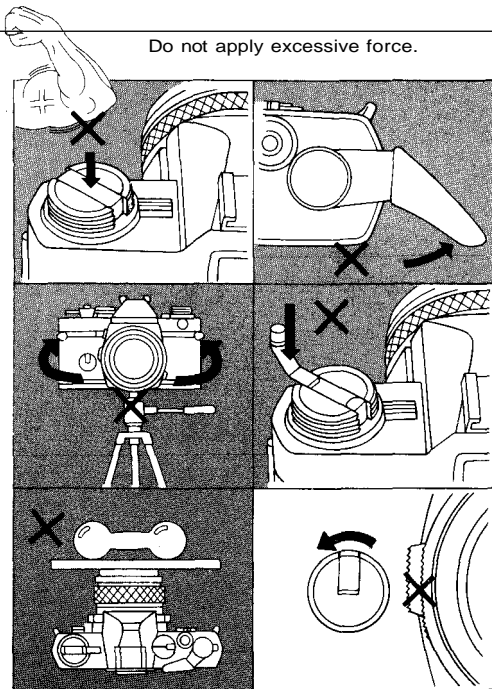

Guard against high temperature and magnetic fields.

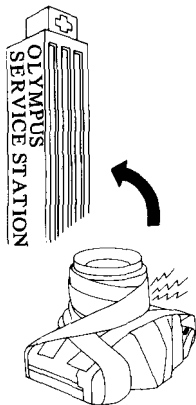
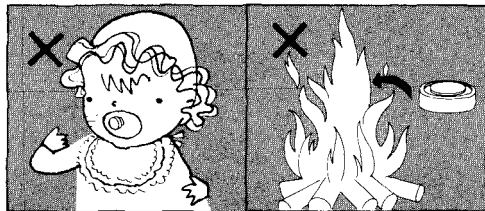
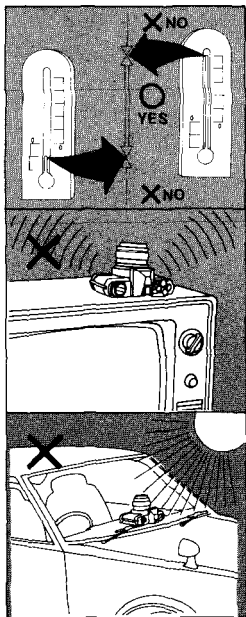

In case of malfunction, take the camera to your nearest Olympus service station.

Description of Controls

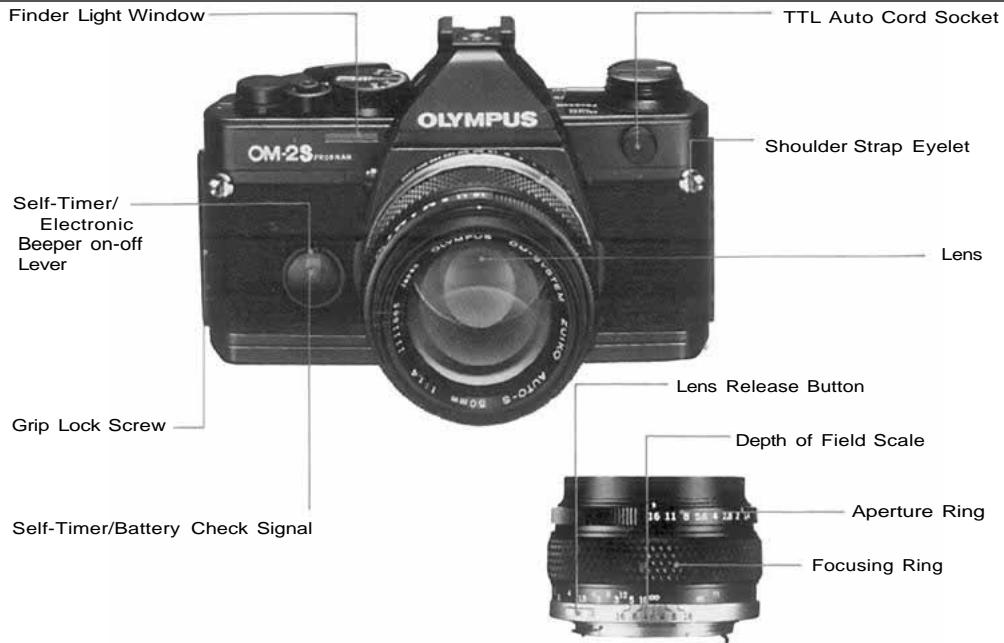

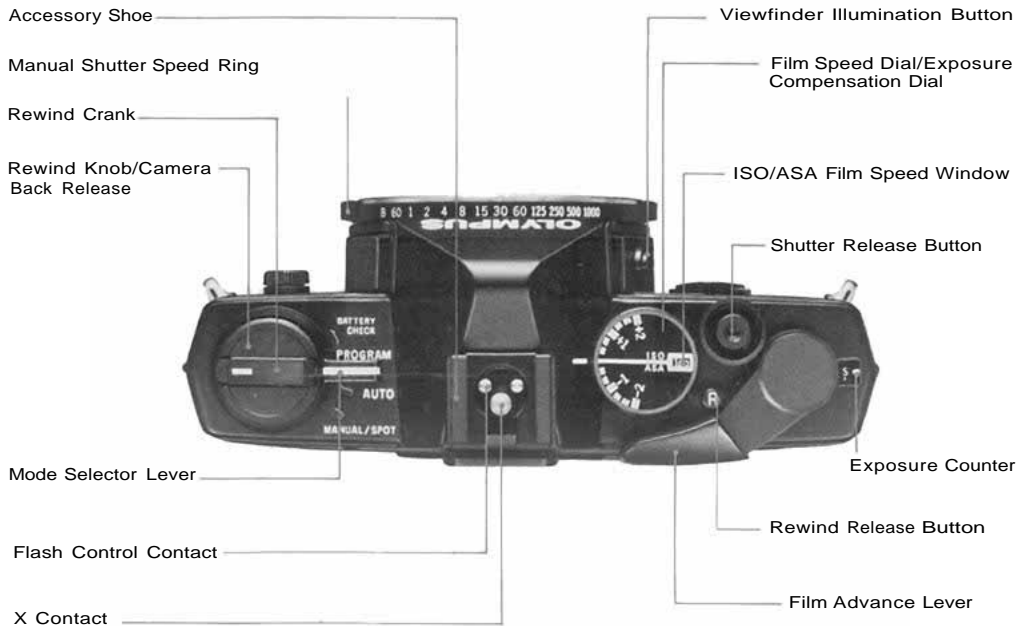

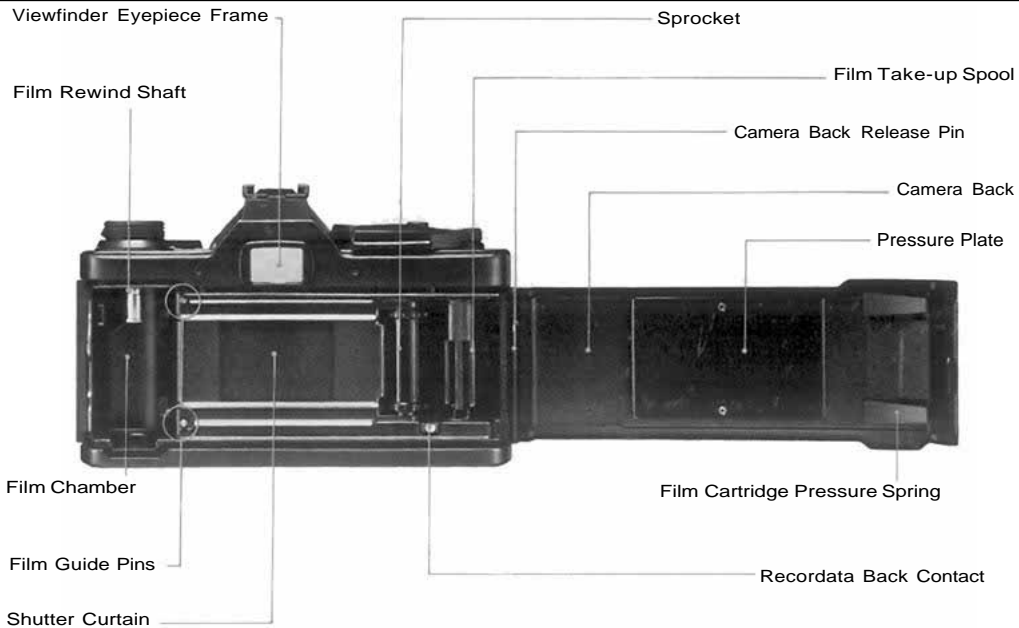

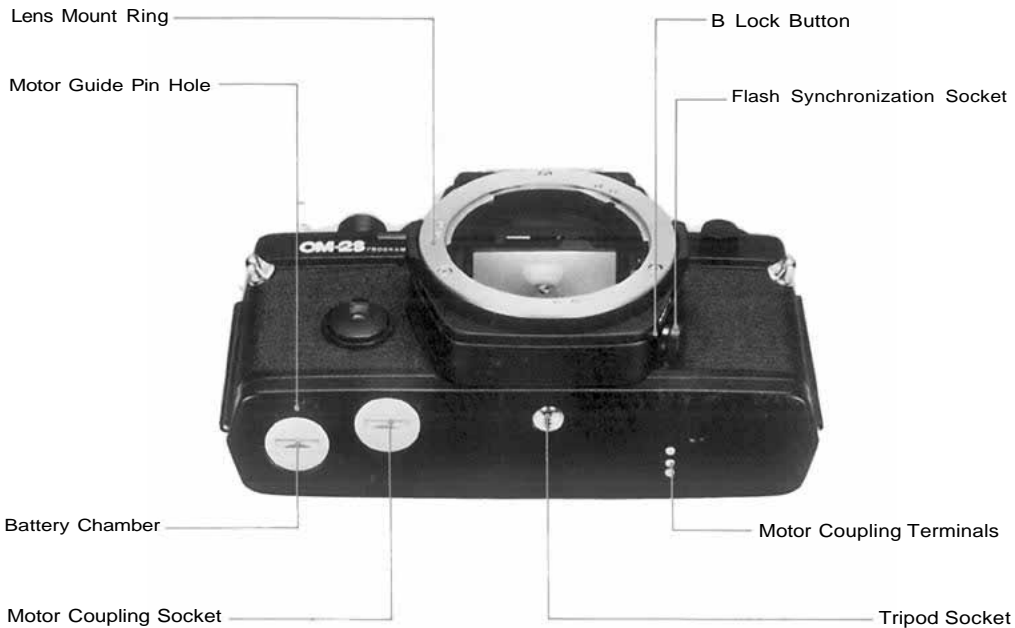

Specifications

Type: TTL auto-exposure 35mm SLR camera

Film Format: 24mm x 36mm

Lens Mount: Olympus OM mount

Shutter: Electronically controlled cloth focal plane shutter; 1/1000 sec. max. shutter speed; 1/60 sec. mechanical shutter speed

Synchronization: X contact (synchronization at speeds of 1/60 sec. or slower; hot shoe with contact for T-series flash; 5-pin connector for T-series flash; PC synchro socket

Metering system: Olympus direct metering in body; viewfinder display for center-weighted averaged metering and spot metering; TTL direct (off-the-film) light metering for automatic exposure control; SBC photocell

Programmed Automatic Exposure: Type: Programmed exposure control on TTL direct "off-the-film" light measuring (center-weighted average light measurement); exposure control range: about 1 min. ~ 1/1000 sec.; light measuring range: approx. -5EV ~ 18EV (ISO/ASA 100, 50mm F1.4, normal temperature and humidity); Flash control: Automatic flash exposure at 1/60 sec. or slower speeds with T-series flash; programed automatic aperture control

Aperture-preferred Automatic Exposure: Type: Automatic exposure control by TTL direct "off-the-film" light measuring with aperture-preferred electronic shutter (center-weighted average light measurement); exposure control range: about 1 min. ~ 1/1000 sec.; light measuring range: approx. -5EV ~ 18EV (ISO/ASA 100, 50mm F1.4, normal temperature and humidity); Flash control: Automatic flash exposure at 1/60 sec. or slower speeds with T-series flash

Manual Exposure: Mechanical shutter for B and 1/60 sec., electronic shutter for 1 ~ 1/1000 sec.; fixed point exposure setting; spot metering on microprism of focusing screen 1-13; flash synchronization at 1/60 sec. or slower

Exposure Compensation: 2 steps and 1/3 step

Film Speed: ISO/ASA 12 ~ 3200

Film Advance: Film advance lever with 130° angle for one long or several short strokes and pre-advance angle 30°; motor drive and winder usable

Film Rewind: Rewind crank

Self-timer: 12 sec. delay electronic self-timer

Power Source: Two 1.5V silver-oxide batteries SR44 (Eveready EPX-76) or alkaline manganese batteries LR44

Battery Check: 3-level display with LED and alarm sound; automatic lock with batteries exhausted

Viewfinder: Pentaprism type wide-vision finder; interchangeable focusing screens; microprism/split image-matte type screen standardized; finder view field: 97% of actual picture field; magnification: 0.86x at infinity with 50mm lens

Viewfinder Information: 1) Shutter speeds; 1/3 EV-step bar display of 1 ~ 1/1000 sec. 2) Display in programmed mode: PRGM signal and blinking of OVER (⚡) to indicate that the aperture has to be stopped down. 3) Fixed point display in manual mode 4) Blinking of OVER for overexposure 5) Blinking of + - for exposure compensation 6) ► display at "60" with flash installed 7) Green LED (🟢) lights with flash fully charged 8) On firing flash, green LED blinks to indicate correct exposure; OVER blinks for overexposure, and UNDER for underexposure

Camera Back: Removable hinge type, with memo holder; interchangeable with Recordata Backs and 250 Film Back

Dimensions: 136 x 84 x 50mm (5.35" x 3.30" x 1.97") (body alone)

Weight: 540g. (19 oz.) (body alone)

OM
SYSTEM

OLYMPUS®

OLYMPUS OPTICAL CO.,LTD.

San-Ei Building, 22-2, Nishi Shinjuku 1-chome, Shinjuku-ku Tokyo, Japan. Tel. 03-340-2211

OLYMPUS CORPORATION

Crossways Park, Woodbury, New York 11797, U.S.A. Tel. 516-364-3000

OLYMPUS OPTICAL CO.(EUROPA) GMBH

Postfach 104908, Wendenstrasse 14-16, 2 Hamburg 1, West Germany. Tel: 040-23773-0

OLYMPUS OPTICAL CO. (U.K) LTD.

2-8 Honduras Street, London EC1Y 0TX, England. Tel. 01-253-2772